

PIANI INTEGRATI IN CRISTALPLANT BIOBASED | *CRISTALPLANT BIOBASED BUILT-IN BASINS*

| WASCHTISCHE MIT INTEGRIERTEM WASCHBECKEN AUS CRISTALPLANT BIOBASED | *PLANS VASQUE INTÉGRÉE EN CRISTALPLANT BIOBASED* | ENCIMERAS INTEGRADAS DE CRISTALPLANT BIOBASED





























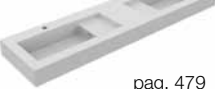



TOP INTEGRATI CRISTALPLANT
CRISTALPLANT BUILT-IN TOP



GAMMA COMPLETA PIANI INTEGRATI | COMPLETE RANGE OF BUILT-IN BASINS

| SORTIMENT KOMPLETT MIT EINGEBAUTEN EBENEN | GAMME COMPLÈTE PLANS VASQUE INTÉGRÉE | GAMA COMPLETA PLANOS INTEGRADOS

	Sp. 1,5 cm Th. 1,5 cm	2 vasche 2 basins	Sp. 12,5 cm Th. 12,5 cm	2 vasche 2 basins	Sp. 12 cm Th. 12 cm	Sp. 10 cm Th. 10 cm
ROUND SOFT	 pag. 458	 pag. 459	 pag. 460	 pag. 461		
OVAL	 pag. 462	 pag. 463	 pag. 464	 pag. 465		
MINI ROUND	 pag. 466	 pag. 467	 pag. 468	 pag. 469		
ROUND	 pag. 470	 pag. 471	 pag. 472	 pag. 473		
SQUARE	 pag. 475/476	 pag. 477	 pag. 478	 pag. 479		
EXTREME FLAT	 pag. 480	 pag. 481	 pag. 482	 pag. 483		
FLAT SOFT	 pag. 484		 pag. 485			
ARC	 pag. 486	 pag. 487	 pag. 488	 pag. 489		
PURE					 pag. 490	
SHAPE						 pag. 491

CARATTERISTICHE | CHARACTERISTICS

| EIGENSCHAFTEN | CARACTERISTIQUES | CARACTERÍSTICAS



Biobased

30% di resine vegetali
OGM free.

30% of vegetable
resins GMO free.



Recyclable

Riciclabile e riutilizzabile
come inerte.

Recyclable and
reusable as inert
material.



Lightweight

Peso ridotto del 30%
minori emissioni di CO2.

30% weight reduction
reduced CO2 emissions.



Durable

5 anni di garanzia.

5 years warranty.



Fire resistant

Reazione al fuoco
classe 1.

Class 1 fire rating.



Easy maintenance

Brucciature sigaretta
facilmente ripristinabili.

Cigarette burns
easily renewable.



Anti-yellowing

Resistenza alla luce
1000 h Xenon.

Light resistance
1000 h xenon lamp.



Resistant to thermal shock

UNI 9429:1989
nessuno difetto.

UNI 9429:1989
no flaws.



Repairable

Graffi e rotture
facilmente ripristinabili.

Scratches and breaks
easily renewable.



No-stain

Macchie facilmente
ripristinabili.

Stains easily
renewable.



Non-toxic

Ipoallergenico e
atossico.

Hypoallergenic and
non-toxic.



Certified quality

Certificato per USA
e CANADA e per
Europa.

Certification for USA
and Canada and for
Europe.



Greenguard Gold

Origine BIO e emissione
sostanze volatili certificata
da UL.

Bio origins and emission
of volatile substances
certified by UL.

Finiture / Finishes / Oberfläche / Finitions / Acabados

CRISTALPLANT BIOBASED

00 **Bianco opaco**
Matt white
Weiss matt
Blanc mat
Blanco mate

Per informazioni su materiali utilizzati e loro cura e manutenzione vedi pag. 676 / For information on the materials used and their care and maintenance see page 676 / Für Informationen zu den verwendeten Materialien sowie ihrer Pflege und Instandhaltung siehe S. 676 / Pour des informations sur les matériaux utilisés et leur soin et entretien, voir page 676 / Para informaciones sobre materiales utilizados y sobre su cuidado y mantenimiento, véase pág. 676

PIANI INTEGRATI IN CRISTALPLANT BIOBASED | CRISTALPLANT BIOBASED BUILT-IN BASINS

| WASCHTISCHE MIT INTEGRIERTEM WASCHBECKEN AUS CRISTALPLANT BIOBASED | PLANS VASQUE INTÉGRÉE EN CRISTALPLANT BIOBASED | ENCIMERAS INTEGRADAS DE CRISTALPLANT BIOBASED

H 1,5

ROUND SOFT

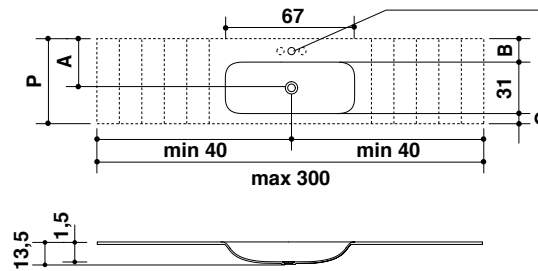
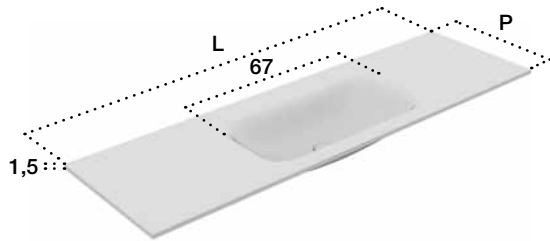

Foro rubinetto a richiesta
Hole drilling on request

Compresso
Free of charge

P	A	B	C
45	25	10	4
55	34	18,5	5,5

Art. DX / RIGHT

Art. SX / LEFT

Art. CX / CENTRAL

P L H

LEI 90 DX	LEK 90 SX	LEL 80 CX	45	80	1,5
LEI 100 DX	LEK 100 SX	LEL 90 CX		90	1,5
LEI 110 DX	LEK 110 SX	LEL 100 CX		100	1,5
LEI 120 DX	LEK 120 SX	LEL 110 CX		110	1,5
LEI 130 DX	LEK 130 SX	LEL 120 CX		120	1,5
LEI 140 DX	LEK 140 SX	LEL 130 CX		130	1,5
LEI 150 DX	LEK 150 SX	LEL 140 CX		140	1,5
LEI 160 DX	LEK 160 SX	LEL 150 CX		150	1,5
LEI 170 DX	LEK 170 SX	LEL 160 CX		160	1,5
LEI 180 DX	LEK 180 SX	LEL 170 CX		170	1,5
LEI 190 DX	LEK 190 SX	LEL 180 CX		180	1,5
LEI 200 DX	LEK 200 SX	LEL 190 CX		190	1,5
LEI 220 DX	LEK 220 SX	LEL 200 CX		200	1,5
LEI 240 DX	LEK 240 SX	LEL 220 CX		220	1,5
LEI 260 DX	LEK 260 SX	LEL 240 CX		240	1,5
LEI 280 DX	LEK 280 SX	LEL 260 CX		260	1,5
LEI 300 DX	LEK 300 SX	LEL 280 CX		280	1,5
		LEL 300 CX		300	1,5

LEM 90 DX	LEN 90 SX	LEP 80 CX	55	80	1,5
LEM 100 DX	LEN 100 SX	LEP 90 CX		90	1,5
LEM 110 DX	LEN 110 SX	LEP 100 CX		100	1,5
LEM 120 DX	LEN 120 SX	LEP 110 CX		110	1,5
LEM 130 DX	LEN 130 SX	LEP 120 CX		120	1,5
LEM 140 DX	LEN 140 SX	LEP 130 CX		130	1,5
LEM 150 DX	LEN 150 SX	LEP 140 CX		140	1,5
LEM 160 DX	LEN 160 SX	LEP 150 CX		150	1,5
LEM 170 DX	LEN 170 SX	LEP 160 CX		160	1,5
LEM 180 DX	LEN 180 SX	LEP 170 CX		170	1,5
LEM 190 DX	LEN 190 SX	LEP 180 CX		180	1,5
LEM 200 DX	LEN 200 SX	LEP 190 CX		190	1,5
LEM 220 DX	LEN 220 SX	LEP 200 CX		200	1,5
LEM 240 DX	LEN 240 SX	LEP 220 CX		220	1,5
LEM 260 DX	LEN 260 SX	LEP 240 CX		240	1,5
LEM 280 DX	LEN 280 SX	LEP 260 CX		260	1,5
LEM 300 DX	LEN 300 SX	LEP 280 CX		280	1,5
		LEP 300 CX		300	1,5



P min - max L min - max

45 - 55 80 - 300

Maggiorazione sulla misura superiore / Surcharge on larger size / Aufschlag für größeres Maß / Majoration sur la dimension supérieure / Aumento en la medida superior

Accessori compresi / Included accessories

Accessori suggeriti / suggested accessories

Piletta / Waste Art. 66A	Copri piletta in finitura / Drain cover in finish Cristalplant	Troppo pieno / Overflow No	Sifone / Trap 673
-----------------------------	---	-------------------------------	----------------------



Top compatibile con collezioni / Top compatible with collections:
PURE ELEMENTS - VIAVENETO ELEMENTS - VIAVENETO|G ELEMENTS

68J

Kit foro e scarico troppo pieno a richiesta con piletta Push / Hole and drain overflow kit upon request with Push waste / Überlaufsatz auf Anfrage mit Druckablaufventil / Kit trou et vidage trop plein sur demande avec bonde a pression / Kit orificio y descarga rebosadero bajo pedido con rejilla a pression

NOTE **01** **08**

PIANI INTEGRATI IN CRISTALPLANT BIOBASED | CRISTALPLANT BIOBASED BUILT-IN BASINS

| WASCHTISCHE MIT INTEGRIERTEM WASCHBECKEN AUS CRISTALPLANT BIOBASED | PLANS VASQUE INTÉGRÉE EN CRISTALPLANT BIOBASED | ENCIMERAS INTEGRADAS DE CRISTALPLANT BIOBASED

H 1,5

ROUND SOFT

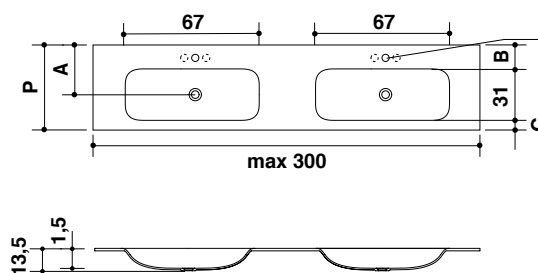
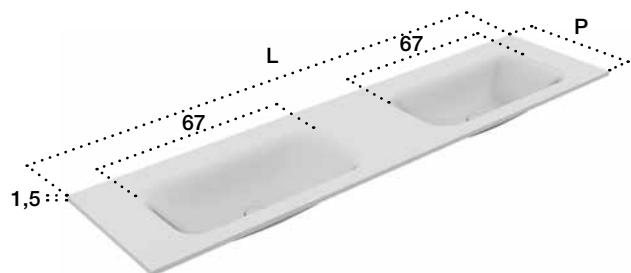

Foro rubinetto a richiesta
Hole drilling on request

Compreso
Free of charge

P	A	B	C
45	25	10	4
55	34	18,5	5,5

Art.	P	L	H
LEQ 160	45	160	1,5
LEQ 180		180	1,5
LEQ 190		190	1,5
LEQ 200		200	1,5
LEQ 220		220	1,5
LEQ 240		240	1,5
LEQ 260		260	1,5
LEQ 280		280	1,5
LEQ 300		300	1,5

LER 160	55	160	1,5
LER 180		180	1,5
LER 190		190	1,5
LER 200		200	1,5
LER 220		220	1,5
LER 240		240	1,5
LER 260		260	1,5
LER 280		280	1,5
LER 300		300	1,5



P min - max L min - max

45 - 55 160 - 300

Maggiorazione sulla misura superiore / Surcharge on larger size / Aufschlag für größeres Maß / Majoration sur la dimension supérieure / Aumento en la medida superior

Accessori compresi / Included accessories

Accessori suggeriti / suggested accessories

Piletta / Waste Art. 66A	Copri piletta in finitura / Drain cover in finish Cristalplant	Troppo pieno / Overflow No
-----------------------------	---	-------------------------------

Sifone / Trap 673



Top compatibile con collezioni / Top compatible with collections:

PURE ELEMENTS - VIAVENETO ELEMENTS - VIAVENETO|G ELEMENTS

68J Kit foro e scarico troppo pieno a richiesta con piletta Push / Hole and drain overflow kit upon request with Push waste / Überlaufsatz auf Anfrage mit Druckablaufventil / Kit trou et vidage trop plein sur demande avec bonde a pression / Kit orificio y descarga rebosadero bajo pedido con rejilla a pression

****Centro lavabo posizionabile su richiesta salvo distanza minima laterale di 4,5 cm / The washbasin center can be positioned on request except for a minimum lateral distance of 4.5 cm / Position der Waschbeckenmitte auf Anfrage, mit seitlichen Mindestabstand von 4,5 cm / Le centre du lavabo peut être positionné à la demande, ad exception d'une distance minimum latérale de 4,5 cm / El centro del lavabo puede ser situado a la solicitud, con una distancia lateral mínima de 4,5 cm.**

NOTE **01** **08**

PIANI INTEGRATI IN CRISTALPLANT BIOBASED | CRISTALPLANT BIOBASED BUILT-IN BASINS

| WASCHTISCHE MIT INTEGRIERTEM WASCHBECKEN AUS CRISTALPLANT BIOBASED | PLANS VASQUE INTÉGRÉE EN CRISTALPLANT BIOBASED | ENCIMERAS INTEGRADAS DE CRISTALPLANT BIOBASED

H 12,5

ROUND SOFT

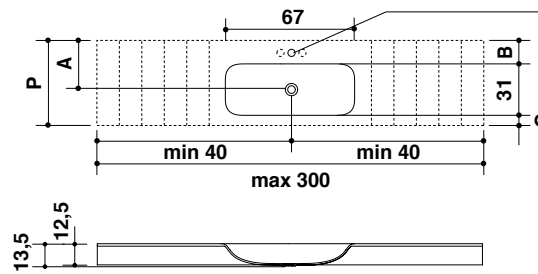
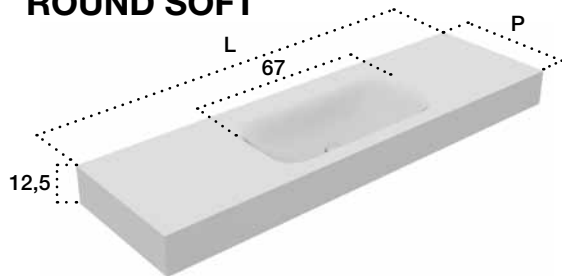

Foro rubinetto a richiesta
Hole drilling on request

Compreso
Free of charge

P	A	B	C
45	25	10	4
55	34	18,5	5,5

Art. DX / RIGHT

Art. SX / LEFT

Art. CX / CENTRAL

P L H

LFA 90 DX	LFB 90 SX	LFC 80 CX	45	80	12,5
LFA 100 DX	LFB 100 SX	LFC 90 CX		90	12,5
LFA 110 DX	LFB 110 SX	LFC 100 CX		100	12,5
LFA 120 DX	LFB 120 SX	LFC 110 CX		110	12,5
LFA 130 DX	LFB 130 SX	LFC 120 CX		120	12,5
LFA 140 DX	LFB 140 SX	LFC 130 CX		130	12,5
LFA 150 DX	LFB 150 SX	LFC 140 CX		140	12,5
LFA 160 DX	LFB 160 SX	LFC 150 CX		150	12,5
LFA 170 DX	LFB 170 SX	LFC 160 CX		160	12,5
LFA 180 DX	LFB 180 SX	LFC 170 CX		170	12,5
LFA 190 DX	LFB 190 SX	LFC 180 CX		180	12,5
LFA 200 DX	LFB 200 SX	LFC 190 CX		190	12,5
LFA 220 DX	LFB 220 SX	LFC 200 CX		200	12,5
LFA 240 DX	LFB 240 SX	LFC 220 CX		220	12,5
LFA 260 DX	LFB 260 SX	LFC 240 CX		240	12,5
LFA 280 DX	LFB 280 SX	LFC 260 CX		260	12,5
LFA 300 DX	LFB 300 SX	LFC 280 CX		280	12,5
		LFC 300 CX		300	12,5

LFD 90 DX	LFE 90 SX	LFF 80 CX	55	80	12,5
LFD 100 DX	LFE 100 SX	LFF 90 CX		90	12,5
LFD 110 DX	LFE 110 SX	LFF 100 CX		100	12,5
LFD 120 DX	LFE 120 SX	LFF 110 CX		110	12,5
LFD 130 DX	LFE 130 SX	LFF 120 CX		120	12,5
LFD 140 DX	LFE 140 SX	LFF 130 CX		130	12,5
LFD 150 DX	LFE 150 SX	LFF 140 CX		140	12,5
LFD 160 DX	LFE 160 SX	LFF 150 CX		150	12,5
LFD 170 DX	LFE 170 SX	LFF 160 CX		160	12,5
LFD 180 DX	LFE 180 SX	LFF 170 CX		170	12,5
LFD 190 DX	LFE 190 SX	LFF 180 CX		180	12,5
LFD 200 DX	LFE 200 SX	LFF 190 CX		190	12,5
LFD 220 DX	LFE 220 SX	LFF 200 CX		200	12,5
LFD 240 DX	LFE 240 SX	LFF 220 CX		220	12,5
LFD 260 DX	LFE 260 SX	LFF 240 CX		240	12,5
LFD 280 DX	LFE 280 SX	LFF 260 CX		260	12,5
LFD 300 DX	LFE 300 SX	LFF 280 CX		280	12,5
		LFF 300 CX		300	12,5



P min - max L min - max

45 - 55 80 - 300

Maggiorazione sulla misura superiore / Surcharge on larger size / Aufschlag für größeres Maß / Majoration sur la dimension supérieure / Aumento en la medida superior

Accessori compresi / Included accessories

Accessori suggeriti / suggested accessories

Piletta / Waste Art. 66A	Copri piletta in finitura / Drain cover in finish Cristalplant	Troppo pieno / Overflow No	Sifone / Trap 673
-----------------------------	---	-------------------------------	----------------------



Top compatibile con collezioni / Top compatible with collections:

PURE ELEMENTS - VIAVENETO ELEMENTS - VIAVENETO|G ELEMENTS

68J Kit foro e scarico troppo pieno a richiesta con piletta Push / Hole and drain overflow kit upon request with Push waste / Überlaufsatz auf Anfrage mit Druckablaufventil / Kit trou et vidage trop plein sur demande avec bonde a pression / Kit orificio y descarga rebosadero bajo pedido con rejilla a pression

D7G Staffa supporto top / Top brackets / Stützbugel für Top / Patte de support / Soporte encimera fino a cm 90 = n° 2 - da cm 91 a 180 = n° 3 - da cm 181 a 250 = n° 4 - da cm 251 a 300 = n° 5

NOTE **01** **08**

PIANI INTEGRATI IN CRISTALPLANT BIOBASED | CRISTALPLANT BIOBASED BUILT-IN BASINS

| WASCHTISCHE MIT INTEGRIERTEM WASCHBECKEN AUS CRISTALPLANT BIOBASED | PLANS VASQUE INTÉGRÉE EN CRISTALPLANT BIOBASED | ENCIMERAS INTEGRADAS DE CRISTALPLANT BIOBASED

H 12,5

ROUND SOFT

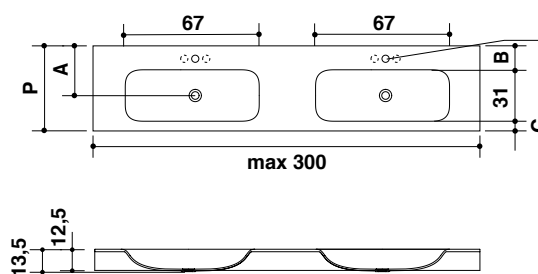
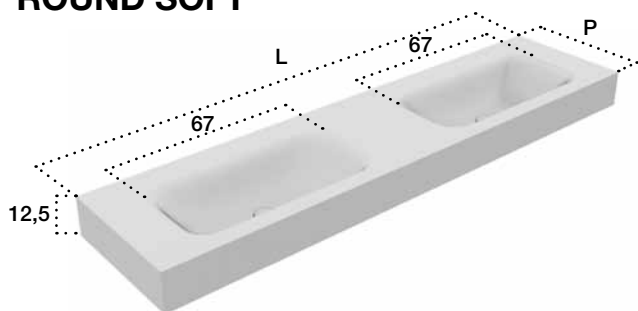

Foro rubinetto a richiesta
Hole drilling on request

Compreso
Free of charge

P	A	B	C
45	25	10	4
55	34	18,5	5,5

Art. P L H

LFG 160	45	160	12,5
LFG 180		180	12,5
LFG 190		190	12,5
LFG 200		200	12,5
LFG 220		220	12,5
LFG 240		240	12,5
LFG 260		260	12,5
LFG 280		280	12,5
LFG 300		300	12,5

LFH 160	55	160	12,5
LFH 180		180	12,5
LFH 190		190	12,5
LFH 200		200	12,5
LFH 220		220	12,5
LFH 240		240	12,5
LFH 260		260	12,5
LFH 280		280	12,5
LFH 300		300	12,5



P min - max L min - max

45 - 55 160 - 300

Maggiorazione sulla misura superiore / Surcharge on larger size / Aufschlag für größeres Maß / Majoration sur la dimension supérieure / Aumento en la medida superior

Accessori compresi / Included accessories

Accessori suggeriti / suggested accessories

Piletta / Waste Art. 66A	Copri piletta in finitura / Drain cover in finish Cristalplant	Troppo pieno / Overflow No	Sifone / Trap 673
-----------------------------	---	-------------------------------	----------------------



Top compatibile con collezioni / Top compatible with collections:

PURE ELEMENTS - VIAVENETO ELEMENTS - VIAVENETO|G ELEMENTS

68J Kit foro e scarico troppo pieno a richiesta con piletta Push / Hole and drain overflow kit upon request with Push waste / Überlaufsatz auf Anfrage mit Druckablaufventil / Kit trou et vidage trop plein sur demande avec bonde a pression / Kit orificio y descarga rebosadero bajo pedido con rejilla a pression

D7G Staffa supporto top / Top brackets / Stützbügel für Top / Patte de support / Soporte encimera
fino a cm 90 = n° 2 - da cm 91 a 180 = n° 3 - da cm 181 a 250 = n° 4 - da cm 251 a 300 = n° 5

****Centro lavabo posizionabile su richiesta salvo distanza minima laterale di 4,5 cm / The washbasin center can be positioned on request except for a minimum lateral distance of 4.5 cm / Position der Waschbeckenmitte auf Anfrage, mit seitlichen Mindestabstand von 4,5 cm / Le centre du lavabo peut être positionné à la demande, ad exception d'une distance minimum latérale de 4,5 cm / El centro del lavabo puede ser situado a la solicitud, con una distancia lateral mínima de 4,5 cm.**

NOTE **01 08**

PIANI INTEGRATI IN CRISTALPLANT BIOBASED | CRISTALPLANT BIOBASED BUILT-IN BASINS

| WASCHTISCHE MIT INTEGRIERTEM WASCHBECKEN AUS CRISTALPLANT BIOBASED | PLANS VASQUE INTÉGRÉE EN CRISTALPLANT BIOBASED | ENCIMERAS INTEGRADAS DE CRISTALPLANT BIOBASED

H 1,5

OVAL

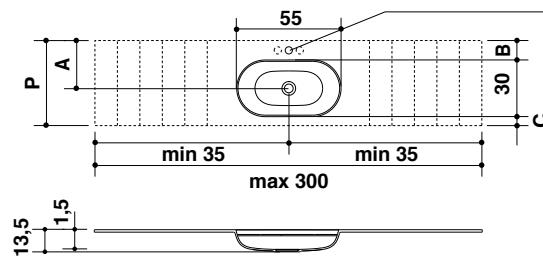
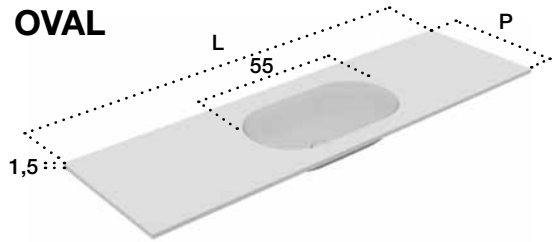

Foro rubinetto a richiesta
Hole drilling on request

Compreso
Free of charge

P	A	B	C
45	25	10	5
55	34	19	6

Art. DX / RIGHT	Art. SX / LEFT	Art. CX / CENTRAL	P	L	H
		LFU 70 CX	45	70	1,5
		LFU 80 CX		80	1,5
		LFU 90 CX		90	1,5
		LFU 100 CX		100	1,5
		LFU 110 CX		110	1,5
		LFU 120 CX		120	1,5
		LFU 130 CX		130	1,5
		LFU 140 CX		140	1,5
		LFU 150 CX		150	1,5
		LFU 160 CX		160	1,5
		LFU 170 CX		170	1,5
		LFU 180 CX		180	1,5
		LFU 190 CX		190	1,5
		LFU 200 CX		200	1,5
		LFU 220 CX		220	1,5
		LFU 240 CX		240	1,5
		LFU 260 CX		260	1,5
		LFU 280 CX		280	1,5
		LFU 300 CX		300	1,5

		LFX 70 CX	55	70	1,5
		LFX 80 CX		80	1,5
		LFX 90 CX		90	1,5
		LFX 100 CX		100	1,5
		LFX 110 CX		110	1,5
		LFX 120 CX		120	1,5
		LFX 130 CX		130	1,5
		LFX 140 CX		140	1,5
		LFX 150 CX		150	1,5
		LFX 160 CX		160	1,5
		LFX 170 CX		170	1,5
		LFX 180 CX		180	1,5
		LFX 190 CX		190	1,5
		LFX 200 CX		200	1,5
		LFX 220 CX		220	1,5
		LFX 240 CX		240	1,5
		LFX 260 CX		260	1,5
		LFX 280 CX		280	1,5
		LFX 300 CX		300	1,5



P min - max L min - max

45 - 55 70 - 300

Maggiorazione sulla misura superiore / Surcharge on larger size / Aufschlag für größeres Maß / Majoration sur la dimension supérieure / Aumento en la medida superior

Accessori compresi / Included accessories

Accessori suggeriti / suggested accessories

Piletta / Waste Art. 66A	Copri piletta in finitura / Drain cover in finish Cristalplant	Troppo pieno / Overflow No
-----------------------------	---	-------------------------------

Sifone / Trap 673



Top compatibile con collezioni / Top compatible with collections:

PURE ELEMENTS - VIAVENETO ELEMENTS - VIAVENETO|G ELEMENTS

68J

Kit foro e scarico troppo pieno a richiesta con piletta Push / Hole and drain overflow kit upon request with Push waste / Überlaufsatz auf Anfrage mit Druckablaufventil / Kit trou et vidage trop plein sur demande avec bonde a pression / Kit orificio y descarga rebosadero bajo pedido con rejilla a pression

NOTE 01 08

PIANI INTEGRATI IN CRISTALPLANT BIOBASED | CRISTALPLANT BIOBASED BUILT-IN BASINS

| WASCHTISCHE MIT INTEGRIERTEM WASCHBECKEN AUS CRISTALPLANT BIOBASED | PLANS VASQUE INTÉGRÉE EN CRISTALPLANT BIOBASED | ENCIMERAS INTEGRADAS DE CRISTALPLANT BIOBASED

H 1,5

OVAL

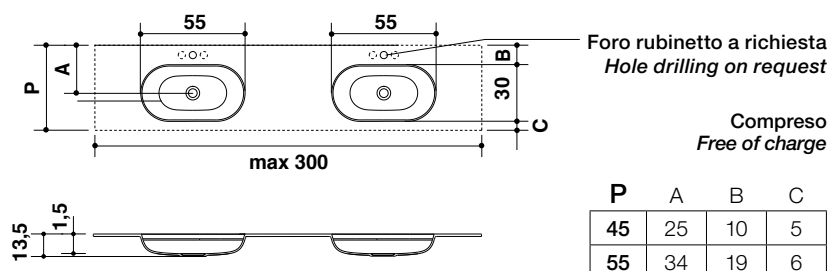
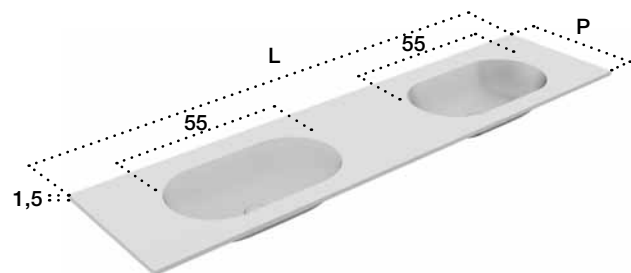

Compresso
Free of charge

Art.	P	L	H
LFY 140	45	140	1,5
LFY 160		160	1,5
LFY 180		180	1,5
LFY 190		190	1,5
LFY 200		200	1,5
LFY 220		220	1,5
LFY 240		240	1,5
LFY 260		260	1,5
LFY 280		280	1,5
LFY 300		300	1,5

LFZ 140	55	140	1,5
LFZ 160		160	1,5
LFZ 180		180	1,5
LFZ 190		190	1,5
LFZ 200		200	1,5
LFZ 220		220	1,5
LFZ 240		240	1,5
LFZ 260		260	1,5
LFZ 280		280	1,5
LFZ 300		300	1,5



P min - max L min - max

45 - 55 140 - 300

Maggiorazione sulla misura superiore / Surcharge on larger size / Aufschlag für größeres Maß / Majoration sur la dimension supérieure / Aumento en la medida superior

Accessori compresi / Included accessories

Accessori suggeriti / suggested accessories

Piletta / Waste Art. 66A	Copri piletta in finitura / Drain cover in finish Cristalplant	Troppo pieno / Overflow No	Sifone / Trap 673
-----------------------------	---	-------------------------------	----------------------



Top compatibile con collezioni / Top compatible with collections:

PURE ELEMENTS - VIAVENETO ELEMENTS - VIAVENETO|G ELEMENTS

68J Kit foro e scarico troppo pieno a richiesta con piletta Push / Hole and drain overflow kit upon request with Push waste / Überlaufsaß auf Anfrage mit Druckablaufventil / Kit trou et vidage trop plein sur demande avec bonde a pression / Kit orificio y descarga rebosadero bajo pedido con rejilla a pression

****Centro lavabo posizionabile su richiesta salvo distanza minima laterale di 4,5 cm / The washbasin center can be positioned on request except for a minimum lateral distance of 4.5 cm / Position der Waschbeckenmitte auf Anfrage, mit seitlichen Mindestabstand von 4,5 cm / Le centre du lavabo peut etre positionné à la demande, ad exception d'une distance minimum latérale de 4,5 cm / El centro del lavabo puede ser situado a la solicitud, con una distancia lateral mínima de 4,5 cm.**

NOTE **01 08**

PIANI INTEGRATI IN CRISTALPLANT BIOBASED | CRISTALPLANT BIOBASED BUILT-IN BASINS

| WASCHTISCHE MIT INTEGRIERTEM WASCHBECKEN AUS CRISTALPLANT BIOBASED | PLANS VASQUE INTÉGRÉE EN CRISTALPLANT BIOBASED | ENCIMERAS INTEGRADAS DE CRISTALPLANT BIOBASED

H 12,5

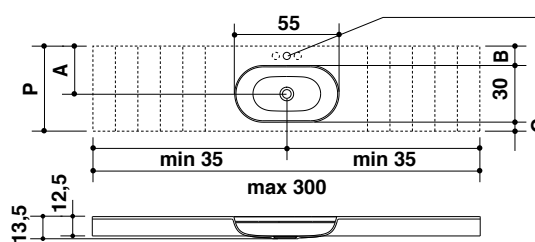
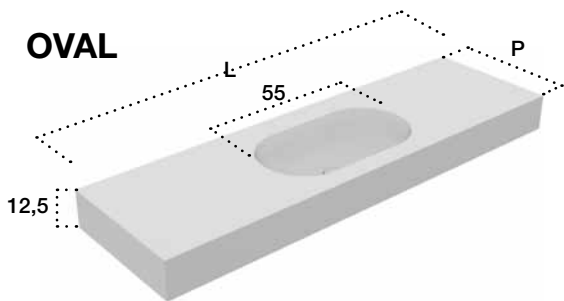

Foro rubinetto a richiesta
Hole drilling on request

Compreso
Free of charge

P	A	B	C
45	25	10	5
55	34	19	6

Art. DX / RIGHT

Art. SX / LEFT

Art. CX / CENTRAL

P L H

			45	70	12,5
				80	12,5
				90	12,5
LGJ 90 DX	LGK 90 SX	LGL 70 CX			
LGJ 100 DX	LGK 100 SX	LGL 80 CX			
LGJ 110 DX	LGK 110 SX	LGL 90 CX			
LGJ 120 DX	LGK 120 SX	LGL 100 CX			
LGJ 130 DX	LGK 130 SX	LGL 110 CX			
LGJ 140 DX	LGK 140 SX	LGL 120 CX			
LGJ 150 DX	LGK 150 SX	LGL 130 CX			
LGJ 160 DX	LGK 160 SX	LGL 140 CX			
LGJ 170 DX	LGK 170 SX	LGL 150 CX			
LGJ 180 DX	LGK 180 SX	LGL 160 CX			
LGJ 190 DX	LGK 190 SX	LGL 170 CX			
LGJ 200 DX	LGK 200 SX	LGL 180 CX			
LGJ 220 DX	LGK 220 SX	LGL 190 CX			
LGJ 240 DX	LGK 240 SX	LGL 200 CX			
LGJ 260 DX	LGK 260 SX	LGL 220 CX			
LGJ 280 DX	LGK 280 SX	LGL 240 CX			
LGJ 300 DX	LGK 300 SX	LGL 260 CX			
		LGL 280 CX			
		LGL 300 CX			

			55	70	12,5
				80	12,5
				90	12,5
LGM 90 DX	LGN 90 SX	LGP 70 CX			
LGM 100 DX	LGN 100 SX	LGP 80 CX			
LGM 110 DX	LGN 110 SX	LGP 90 CX			
LGM 120 DX	LGN 120 SX	LGP 100 CX			
LGM 130 DX	LGN 130 SX	LGP 110 CX			
LGM 140 DX	LGN 140 SX	LGP 120 CX			
LGM 150 DX	LGN 150 SX	LGP 130 CX			
LGM 160 DX	LGN 160 SX	LGP 140 CX			
LGM 170 DX	LGN 170 SX	LGP 150 CX			
LGM 180 DX	LGN 180 SX	LGP 160 CX			
LGM 190 DX	LGN 190 SX	LGP 170 CX			
LGM 200 DX	LGN 200 SX	LGP 180 CX			
LGM 220 DX	LGN 220 SX	LGP 190 CX			
LGM 240 DX	LGN 240 SX	LGP 200 CX			
LGM 260 DX	LGN 260 SX	LGP 220 CX			
LGM 280 DX	LGN 280 SX	LGP 240 CX			
LGM 300 DX	LGN 300 SX	LGP 260 CX			
		LGP 280 CX			
		LGP 300 CX			



P min - max L min - max

45 - 55 70 - 300

Maggiorazione sulla misura superiore / Surcharge on larger size / Aufschlag für größeres Maß / Majoration sur la dimension supérieure / Aumento en la medida superior

Accessori compresi / Included accessories

Accessori suggeriti / suggested accessories

Piletta / Waste Art. 66A	Copri piletta in finitura / Drain cover in finish Cristalplant	Troppo pieno / Overflow No	Sifone / Trap 673
-----------------------------	---	-------------------------------	----------------------



Top compatibile con collezioni / Top compatible with collections:

PURE ELEMENTS - VIAVENETO ELEMENTS - VIAVENETOJG ELEMENTS

68J Kit foro e scarico troppo pieno a richiesta con piletta Push / Hole and drain overflow kit upon request with Push waste / Überlaufsatz auf Anfrage mit Druckablaufventil / Kit trou et vidage trop plein sur demande avec bonde a pression / Kit orificio y descarga rebosadero bajo pedido con rejilla a pression

D7G Staffa supporto top / Top brackets / Stützbügel für Top / Patte de support / Soporte encimera
fino a cm 90 = n° 2 - da cm 91 a 180 = n° 3 - da cm 181 a 250 = n° 4 - da cm 251 a 300 = n° 5

NOTE **01** **08**

PIANI INTEGRATI IN CRISTALPLANT BIOBASED | CRISTALPLANT BIOBASED BUILT-IN BASINS

| WASCHTISCHE MIT INTEGRIERTEM WASCHBECKEN AUS CRISTALPLANT BIOBASED | PLANS VASQUE INTÉGRÉE EN CRISTALPLANT BIOBASED | ENCIMERAS INTEGRADAS DE CRISTALPLANT BIOBASED

H 12,5

OVAL

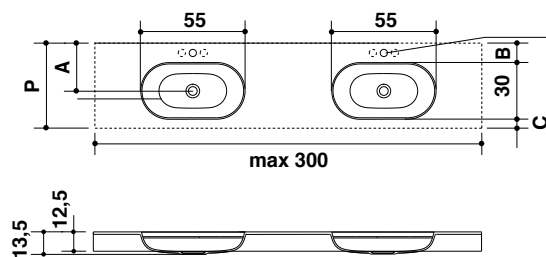
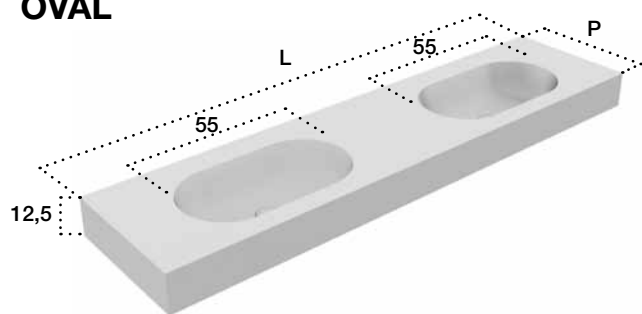

Foro rubinetto a richiesta
Hole drilling on request

Compreso
Free of charge

P	A	B	C
45	25	10	5
55	34	19	6

Art.	P	L	H
LGQ 140	45	140	12,5
LGQ 160		160	12,5
LGQ 180		180	12,5
LGQ 190		190	12,5
LGQ 200		200	12,5
LGQ 220		220	12,5
LGQ 240		240	12,5
LGQ 260		260	12,5
LGQ 280		280	12,5
LGQ 300		300	12,5

LGR 140	55	140	12,5
LGR 160		160	12,5
LGR 180		180	12,5
LGR 190		190	12,5
LGR 200		200	12,5
LGR 220		220	12,5
LGR 240		240	12,5
LGR 260		260	12,5
LGR 280		280	12,5
LGR 300		300	12,5



P min - max L min - max

45 - 55 140 - 300

Maggiorazione sulla misura superiore / Surcharge on larger size / Aufschlag für größeres Maß / Majoration sur la dimension supérieure / Aumento en la medida superior

Accessori compresi / Included accessories

Accessori suggeriti / suggested accessories

Piletta / Waste Art. 66A	Copri piletta in finitura / Drain cover in finish Cristalplant	Troppo pieno / Overflow No
-----------------------------	---	-------------------------------

Sifone / Trap 673



Top compatibile con collezioni / Top compatible with collections:

PURE ELEMENTS - VIAVENETO ELEMENTS - VIAVENETO|G ELEMENTS

68J Kit foro e scarico troppo pieno a richiesta con piletta Push / Hole and drain overflow kit upon request with Push waste / Überlaufsaß auf Anfrage mit Druckablaufventil / Kit trou et vidage trop plein sur demande avec bonde a pression / Kit orificio y descarga rebosadero bajo pedido con rejilla a pression

D7G Staffa supporto top / Top brackets / Stützbügel für Top / Patte de support / Soporte encimera
fino a cm 90 = n° 2 - da cm 91 a 180 = n° 3 - da cm 181 a 250 = n° 4 - da cm 251 a 300 = n° 5

**Centro lavabo posizionabile su richiesta salvo distanza minima laterale di 4,5 cm / The washbasin center can be positioned on request except for a minimum lateral distance of 4.5 cm / Position der Waschbeckenmitte auf Anfrage, mit seitlichen Mindestabstand von 4,5 cm / Le centre du lavabo peut etre positionné à la demande, ad exception d'une distance minimum latérale de 4,5 cm / El centro del lavabo puede ser situado a la solicitud, con una distancia lateral mínima de 4,5 cm.

NOTE **01** **08**

PIANI INTEGRATI IN CRISTALPLANT BIOBASED | CRISTALPLANT BIOBASED BUILT-IN BASINS

| WASCHTISCHE MIT INTEGRIERTEM WASCHBECKEN AUS CRISTALPLANT BIOBASED | PLANS VASQUE INTÉGRÉE EN CRISTALPLANT BIOBASED | ENCIMERAS INTEGRADAS DE CRISTALPLANT BIOBASED

H 1,5

MINI ROUND

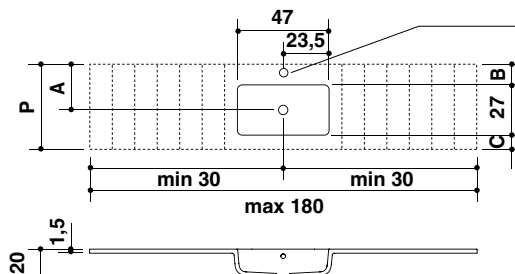
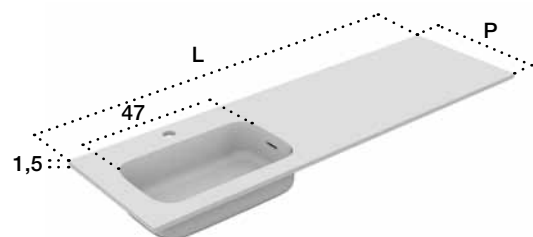

Foro rubinetto a richiesta
Hole drilling on request

Compreso
Free of charge

P	A	B	C
45	23,5	10	8
55	33,5	20	8

Art. DX / RIGHT	Art. SX / LEFT	Art. CX / CENTRAL	P	L	H
		DJF 60 CX	45	60	1,5
		DJF 80 CX		80	1,5
		DJF 90 CX		90	1,5
DJD 90 DX	DJE 90 SX	DJF 100 CX		100	1,5
DJD 100 DX	DJE 100 SX	DJF 110 CX		110	1,5
DJD 110 DX	DJE 110 SX	DJF 120 CX		120	1,5
DJD 120 DX	DJE 120 SX	DJF 130 CX		130	1,5
DJD 130 DX	DJE 130 SX	DJF 140 CX		140	1,5
DJD 140 DX	DJE 140 SX	DJF 150 CX		150	1,5
DJD 150 DX	DJE 150 SX	DJF 160 CX		160	1,5
DJD 160 DX	DJE 160 SX	DJF 170 CX		170	1,5
		DJF 180 CX		180	1,5

		DJI 60 CX	55	60	1,5
		DJI 80 CX		80	1,5
		DJI 90 CX		90	1,5
DJD 90 DX	DJH 90 SX	DJI 100 CX		100	1,5
DJD 100 DX	DJH 100 SX	DJI 110 CX		110	1,5
DJD 110 DX	DJH 110 SX	DJI 120 CX		120	1,5
DJD 120 DX	DJH 120 SX	DJI 130 CX		130	1,5
DJD 130 DX	DJH 130 SX	DJI 140 CX		140	1,5
DJD 140 DX	DJH 140 SX	DJI 150 CX		150	1,5
DJD 150 DX	DJH 150 SX	DJI 160 CX		160	1,5
DJD 160 DX	DJH 160 SX	DJI 170 CX		170	1,5
		DJI 180 CX		180	1,5



P min - max L min - max

35 - 60 60 - 180

Maggiorazione sulla misura superiore / Surcharge on larger size / Aufschlag für größeres Maß / Majoration sur la dimension supérieure / Aumento en la medida superior

Accessori compresi / Included accessories

Piletta / Waste Art. 66D	Copri piletta in finitura / Drain cover in finish Cristalplant	Troppo pieno / Overflow Sì / Yes
-----------------------------	---	-------------------------------------

Accessori suggeriti / suggested accessories

Sifone / Trap 673



Top compatibile con collezioni / Top compatible with collections:

PURE ELEMENTS - VIAVENETO ELEMENTS - VIAVENETOIG ELEMENTS

NOTE 01 08

PIANI INTEGRATI IN CRISTALPLANT BIOBASED | CRISTALPLANT BIOBASED BUILT-IN BASINS

| WASCHTISCHE MIT INTEGRIERTEM WASCHBECKEN AUS CRISTALPLANT BIOBASED | PLANS VASQUE INTÉGRÉE EN CRISTALPLANT BIOBASED | ENCIMERAS INTEGRADAS DE CRISTALPLANT BIOBASED

H 1,5

MINI ROUND

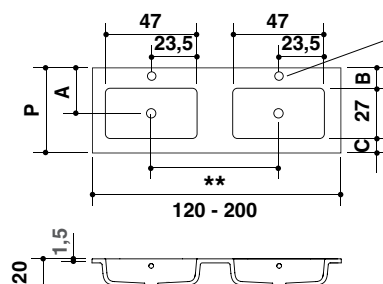
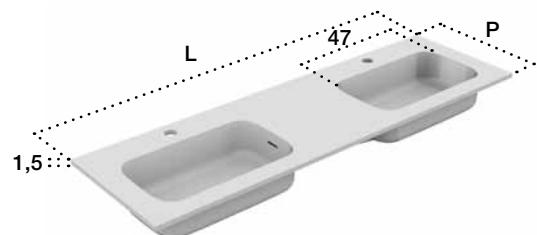

Foro rubinetto a richiesta
Hole drilling on request

Compreso
Free of charge

P	A	B	C
45	23,5	10	8
55	33,5	20	8

Art.	P	L	H
DJK 120	45	120	1,5
DJK 140		140	1,5
DJK 160		160	1,5
DJK 180		180	1,5
DJK 200		200	1,5
<hr/>			
DJL 120	55	120	1,5
DJL 140		140	1,5
DJL 160		160	1,5
DJL 180		180	1,5
DJL 200		200	1,5



P min - max L min - max

35 - 60 120 - 200

Maggiorazione sulla misura superiore / Surcharge on larger size / Aufschlag für größeres Maß / Majoration sur la dimension supérieure / Aumento en la medida superior

Accessori compresi / Included accessories

Accessori suggeriti / suggested accessories

Piletta / Waste Art. 66D	Copri piletta in finitura / Drain cover in finish Cristalplant	Troppo pieno / Overflow Si / Yes
-----------------------------	---	-------------------------------------

Sifone / Trap 673



Top compatibile con collezioni / Top compatible with collections:

PURE ELEMENTS - VIAVENETO ELEMENTS - VIAVENETO|G ELEMENTS

**Centro lavabo posizionabile su richiesta salvo distanza minima laterale di 6,5 cm / The washbasin center can be positioned on request except for a minimum lateral distance of 6.5 cm / Position der Waschbeckenmitte auf Anfrage, mit seitlichen Mindestabstand von 6,5 cm / Le centre du lavabo peut être positionné à la demande, ad exception d'une distance minimum latérale de 6,5 cm / El centro del lavabo puede ser situado a la solicitud, con una distancia lateral mínima de 6,5 cm.

NOTE **01** **08**

PIANI INTEGRATI IN CRISTALPLANT BIOBASED | CRISTALPLANT BIOBASED BUILT-IN BASINS

| WASCHTISCHE MIT INTEGRIERTEM WASCHBECKEN AUS CRISTALPLANT BIOBASED | PLANS VASQUE INTÉGRÉE EN CRISTALPLANT BIOBASED | ENCIMERAS INTEGRADAS DE CRISTALPLANT BIOBASED

H 12,5

MINI ROUND

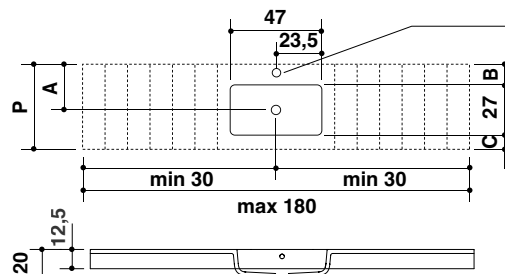
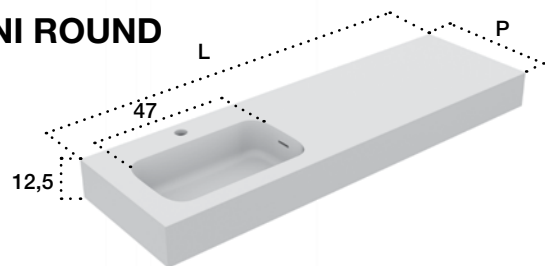

Foro rubinetto a richiesta
Hole drilling on request

Compreso
Free of charge

P	A	B	C
45	23,5	10	8
55	33,5	20	8

Art. DX / RIGHT

Art. SX / LEFT

Art. CX / CENTRAL

P L H

		DJX 60 CX	45	60	12,5
		DJX 80 CX		80	12,5
DJV 90 DX	DJW 90 SX	DJX 90 CX		90	12,5
DJV 100 DX	DJW 100 SX	DJX 100 CX		100	12,5
DJV 110 DX	DJW 110 SX	DJX 110 CX		110	12,5
DJV 120 DX	DJW 120 SX	DJX 120 CX		120	12,5
DJV 130 DX	DJW 130 SX	DJX 130 CX		130	12,5
DJV 140 DX	DJW 140 SX	DJX 140 CX		140	12,5
DJV 150 DX	DJW 150 SX	DJX 150 CX		150	12,5
DJV 160 DX	DJW 160 SX	DJX 160 CX		160	12,5
		DJX 170 CX		170	12,5
		DJX 180 CX		180	12,5

		DTF 60 CX	55	60	12,5
		DTF 80 CX		80	12,5
DJY 90 DX	DJZ 90 SX	DTF 90 CX		90	12,5
DJY 100 DX	DJZ 100 SX	DTF 100 CX		100	12,5
DJY 110 DX	DJZ 110 SX	DTF 110 CX		110	12,5
DJY 120 DX	DJZ 120 SX	DTF 120 CX		120	12,5
DJY 130 DX	DJZ 130 SX	DTF 130 CX		130	12,5
DJY 140 DX	DJZ 140 SX	DTF 140 CX		140	12,5
DJY 150 DX	DJZ 150 SX	DTF 150 CX		150	12,5
DJY 160 DX	DJZ 160 SX	DTF 160 CX		160	12,5
		DTF 170 CX		170	12,5
		DTF 180 CX		180	12,5



P min - max L min - max

35 - 60 60 - 180

Maggiorazione sulla misura superiore / Surcharge on larger size / Aufschlag für größeres Maß / Majoration sur la dimension supérieure / Aumento en la medida superior

Accessori compresi / Included accessories

Accessori suggeriti / suggested accessories

Piletta / Waste Art. 66D	Copri piletta in finitura / Drain cover in finish Cristalplant	Troppo pieno / Overflow Si / Yes	Sifone / Trap 673
-----------------------------	---	-------------------------------------	----------------------



Top compatibile con collezioni / Top compatible with collections:
PURE ELEMENTS - VIAVENETO ELEMENTS - VIAVENETO|G ELEMENTS

D7G Staffa supporto top / Top brackets / Stützbügel für Top / Patte de support / Soporte encimera
fino a cm 90 = n° 2 - da cm 91 a 180 = n° 3

NOTE **01** **08**

PIANI INTEGRATI IN CRISTALPLANT BIOBASED | CRISTALPLANT BIOBASED BUILT-IN BASINS

| WASCHTISCHE MIT INTEGRIERTEM WASCHBECKEN AUS CRISTALPLANT BIOBASED | PLANS VASQUE INTÉGRÉE EN CRISTALPLANT BIOBASED | ENCIMERAS INTEGRADAS DE CRISTALPLANT BIOBASED

H 12,5

MINI ROUND

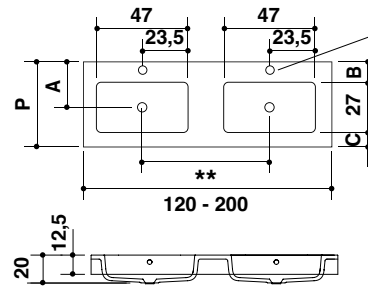
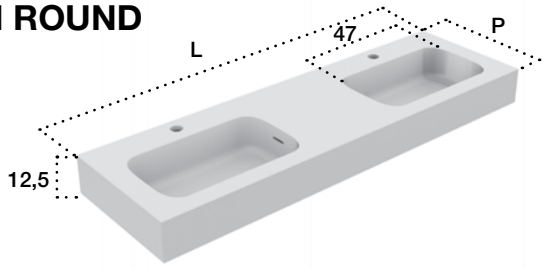

Foro rubinetto a richiesta
Hole drilling on request

Compreso
Free of charge

P	A	B	C
45	23,5	10	8
55	33,5	20	8

Art.	P	L	H
DKB 120	45	120	12,5
DKB 140		140	12,5
DKB 160		160	12,5
DKB 180		180	12,5
DKB 200		200	12,5
<hr/>			
DKK 120	55	120	12,5
DKK 140		140	12,5
DKK 160		160	12,5
DKK 180		180	12,5
DKK 200		200	12,5



P min - max L min - max

35 - 60 120 - 200

Maggiorazione sulla misura superiore / Surcharge on larger size / Aufschlag für größeres Maß / Majoration sur la dimension supérieure / Aumento en la medida superior

Accessori compresi / Included accessories

Accessori suggeriti / suggested accessories

Piletta / Waste Art. 66D	Copri piletta in finitura / Drain cover in finish Cristalplant	Troppo pieno / Overflow Sì / Yes
-----------------------------	---	-------------------------------------

Sifone / Trap 673



Top compatibile con collezioni / Top compatible with collections:

PURE ELEMENTS - VIAVENETO ELEMENTS - VIAVENETO|G ELEMENTS

D7G Staffa supporto top / Top brackets / Stützbügel für Top / Patte de support / Soporte encimera
fino a cm 90 = n° 2 - da cm 91 a 180 = n° 3

**Centro lavabo posizionabile su richiesta salvo distanza minima laterale di 6,5 cm / The washbasin center can be positioned on request except for a minimum lateral distance of 6.5 cm / Position der Waschbeckenmitte auf Anfrage, mit seitlichen Mindestabstand von 6,5 cm / Le centre du lavabo peut être positionné à la demande, ad exception d'une distance minimum latérale de 6,5 cm / El centro del lavabo puede ser situado a la solicitud, con una distancia lateral mínima de 6,5 cm.

NOTE **01** **08**

PIANI INTEGRATI IN CRISTALPLANT BIOBASED | CRISTALPLANT BIOBASED BUILT-IN BASINS

| WASCHTISCHE MIT INTEGRIERTEM WASCHBECKEN AUS CRISTALPLANT BIOBASED | PLANS VASQUE INTÉGRÉE EN CRISTALPLANT BIOBASED | ENCIMERAS INTEGRADAS DE CRISTALPLANT BIOBASED

H 1,5

ROUND

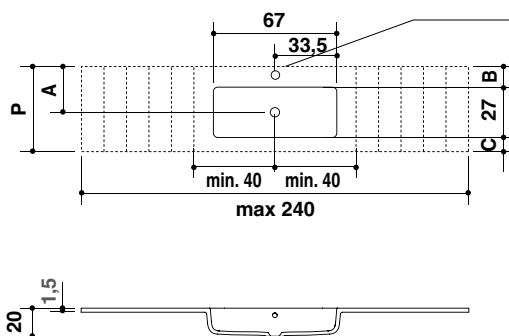
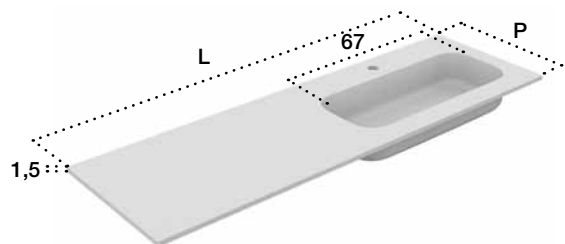

Foro rubinetto a richiesta
Hole drilling on request

Compreso
Free of charge

P	A	B	C
45	23,5	10	8
55	33,5	20	8

Art. DX / RIGHT

Art. SX / LEFT

Art. CX / CENTRAL

P L H

D6E 90 DX	D6F 90 SX	D6G 80 CX	45	80	1,5
D6E 100 DX	D6F 100 SX	D6G 90 CX		90	1,5
D6E 110 DX	D6F 110 SX	D6G 100 CX		100	1,5
D6E 120 DX	D6F 120 SX	D6G 110 CX		110	1,5
D6E 130 DX	D6F 130 SX	D6G 120 CX		120	1,5
D6E 140 DX	D6F 140 SX	D6G 130 CX		130	1,5
D6E 150 DX	D6F 150 SX	D6G 140 CX		140	1,5
D6E 160 DX	D6F 160 SX	D6G 150 CX		150	1,5
D6E 170 DX	D6F 170 SX	D6G 160 CX		160	1,5
D6E 180 DX	D6F 180 SX	D6G 170 CX		170	1,5
D6E 190 DX	D6F 190 SX	D6G 180 CX		180	1,5
D6E 200 DX	D6F 200 SX	D6G 190 CX		190	1,5
D6E 220 DX	D6F 220 SX	D6G 200 CX		200	1,5
D6E 240 DX	D6F 240 SX	D6G 220 CX		220	1,5
D6E 260 DX	D6F 260 SX	D6G 240 CX		240	1,5
D6E 280 DX	D6F 280 SX	D6G 260 CX		260	1,5
D6E 300 DX	D6F 300 SX	D6G 280 CX		280	1,5
		D6G 300 CX		300	1,5

D6I 90 DX	D6J 90 SX	D6K 80 CX	55	80	1,5
D6I 100 DX	D6J 100 SX	D6K 90 CX		90	1,5
D6I 110 DX	D6J 110 SX	D6K 100 CX		100	1,5
D6I 120 DX	D6J 120 SX	D6K 110 CX		110	1,5
D6I 130 DX	D6J 130 SX	D6K 120 CX		120	1,5
D6I 140 DX	D6J 140 SX	D6K 130 CX		130	1,5
D6I 150 DX	D6J 150 SX	D6K 140 CX		140	1,5
D6I 160 DX	D6J 160 SX	D6K 150 CX		150	1,5
D6I 170 DX	D6J 170 SX	D6K 160 CX		160	1,5
D6I 180 DX	D6J 180 SX	D6K 170 CX		170	1,5
D6I 190 DX	D6J 190 SX	D6K 180 CX		180	1,5
D6I 200 DX	D6J 200 SX	D6K 190 CX		190	1,5
D6I 220 DX	D6J 220 SX	D6K 200 CX		200	1,5
D6I 240 DX	D6J 240 SX	D6K 220 CX		220	1,5
D6I 260 DX	D6J 260 SX	D6K 240 CX		240	1,5
D6I 280 DX	D6J 280 SX	D6K 260 CX		260	1,5
D6I 300 DX	D6J 300 SX	D6K 280 CX		280	1,5
		D6K 300 CX		300	1,5



P min - max L min - max

35 - 60 80 - 300

Maggiorazione sulla misura superiore / Surcharge on larger size / Aufschlag für größeres Maß / Majoration sur la dimension supérieure / Aumento en la medida superior

Accessori compresi / Included accessories

Accessori suggeriti / suggested accessories

Piletta / Waste Art. 66D	Copri piletta in finitura / Drain cover in finish Cristalplant	Troppo pieno / Overflow Sì / Yes
-----------------------------	---	-------------------------------------

Sifone / Trap 673



Top compatibile con collezioni / Top compatible with collections:

PURE ELEMENTS - VIAVENETO ELEMENTS - VIAVENETOJG ELEMENTS

NOTE 01 08

PIANI INTEGRATI IN CRISTALPLANT BIOBASED | CRISTALPLANT BIOBASED BUILT-IN BASINS

| WASCHTISCHE MIT INTEGRIERTEM WASCHBECKEN AUS CRISTALPLANT BIOBASED | PLANS VASQUE INTÉGRÉE EN CRISTALPLANT BIOBASED | ENCIMERAS INTEGRADAS DE CRISTALPLANT BIOBASED

H 1,5

ROUND

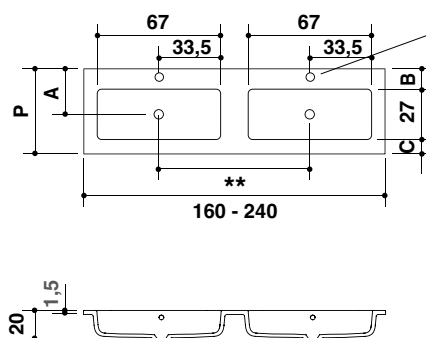
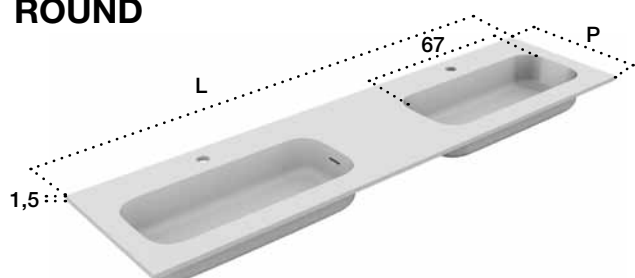

Foro rubinetto a richiesta
Hole drilling on request

Compreso
Free of charge

P	A	B	C
45	23,5	10	8
55	33,5	20	8

Art.	P	L	H
D6H 160	45	160	1,5
D6H 180		180	1,5
D6H 190		190	1,5
D6H 200		200	1,5
D6H 220		220	1,5
D6H 240		240	1,5
D6H 260		260	1,5
D6H 280		280	1,5
D6H 300		300	1,5
<hr/>			
D6L 160	55	160	1,5
D6L 180		180	1,5
D6L 190		190	1,5
D6L 200		200	1,5
D6L 220		220	1,5
D6L 240		240	1,5
D6L 260		260	1,5
D6L 280		280	1,5
D6L 300		300	1,5



P min - max L min - max

35 - 60 160 - 300

Maggiorazione sulla misura superiore / Surcharge on larger size / Aufschlag für größeres Maß / Majoration sur la dimension supérieure / Aumento en la medida superior

Accessori compresi / Included accessories

Accessori suggeriti / suggested accessories

Piletta / Waste Art. 66D	Copri piletta in finitura / Drain cover in finish Cristalplant	Troppo pieno / Overflow Si / Yes	Sifone / Trap 673
-----------------------------	---	-------------------------------------	----------------------



Top compatibile con collezioni / Top compatible with collections:

PURE ELEMENTS - VIAVENETO ELEMENTS - VIAVENETO|G ELEMENTS

**Centro lavabo posizionabile su richiesta salvo distanza minima laterale di 6,5 cm / The washbasin center can be positioned on request except for a minimum lateral distance of 6.5 cm / Position der Waschbeckenmitte auf Anfrage, mit seitlichen Mindestabstand von 6,5 cm / Le centre du lavabo peut être positionné à la demande, ad exception d'une distance minimum latérale de 6,5 cm / El centro del lavabo puede ser situado a la solicitud, con una distancia lateral mínima de 6,5 cm.

NOTE **01** **08**

PIANI INTEGRATI IN CRISTALPLANT BIOBASED | CRISTALPLANT BIOBASED BUILT-IN BASINS

H 12,5

| WASCHTISCHE MIT INTEGRIERTEM WASCHBECKEN AUS CRISTALPLANT BIOBASED | PLANS VASQUE INTÉGRÉE EN CRISTALPLANT BIOBASED | ENCIMERAS INTEGRADAS DE CRISTALPLANT BIOBASED

ROUND

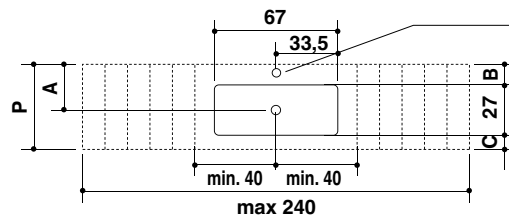
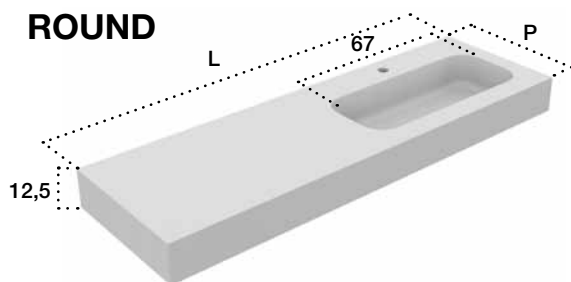

Foro rubinetto a richiesta
Hole drilling on request

Compreso
Free of charge



P	A	B	C
45	23,5	10	8
55	33,5	20	8

Art. DX / RIGHT

Art. SX / LEFT

Art. CX / CENTRAL

P L H

LAL 80 CX	45	80	12,5
LAL 90 CX		90	12,5
LAL 100 CX		100	12,5
LAL 110 CX		110	12,5
LAL 120 CX		120	12,5
LAL 130 CX		130	12,5
LAL 140 CX		140	12,5
LAL 150 CX		150	12,5
LAL 160 CX		160	12,5
LAL 170 CX		170	12,5
LAL 180 CX		180	12,5
LAL 190 CX		190	12,5
LAL 200 CX		200	12,5
LAL 220 CX		220	12,5
LAL 240 CX		240	12,5
LAL 260 CX		260	12,5
LAL 280 CX		280	12,5
LAL 300 CX		300	12,5

LAP 80 CX	55	80	12,5
LAP 90 CX		90	12,5
LAP 100 CX		100	12,5
LAP 110 CX		110	12,5
LAP 120 CX		120	12,5
LAP 130 CX		130	12,5
LAP 140 CX		140	12,5
LAP 150 CX		150	12,5
LAP 160 CX		160	12,5
LAP 170 CX		170	12,5
LAP 180 CX		180	12,5
LAP 190 CX		190	12,5
LAP 200 CX		200	12,5
LAP 220 CX		220	12,5
LAP 240 CX		240	12,5
LAP 260 CX		260	12,5
LAP 280 CX		280	12,5
LAP 300 CX		300	12,5



P min - max L min - max

35 - 60 80 - 300

Maggiorazione sulla misura superiore / Surcharge on larger size / Aufschlag für größeres Maß / Majoration sur la dimension supérieure / Aumento en la medida superior

Accessori compresi / Included accessories

Accessori suggeriti / suggested accessories

Piletta / Waste Art. 66D	Copri piletta in finitura / Drain cover in finish Cristalplant	Troppo pieno / Overflow Sì / Yes
-----------------------------	---	-------------------------------------

Sifone / Trap 673



Top compatibile con collezioni / Top compatible with collections:

PURE ELEMENTS - VIAVENETO ELEMENTS - VIAVENETO|G ELEMENTS

D7G

Staffa supporto top / Top brackets / Stützbügel für Top / Patte de support / Soporte encimera
fino a cm 90 = n° 2 - da cm 91 a 180 = n° 3 - da cm 181 a 250 = n° 4 - da cm 251 a 300 = n° 5

NOTE

01 08

PIANI INTEGRATI IN CRISTALPLANT BIOBASED | CRISTALPLANT BIOBASED BUILT-IN BASINS

| WASCHTISCHE MIT INTEGRIERTEM WASCHBECKEN AUS CRISTALPLANT BIOBASED | PLANS VASQUE INTÉGRÉE EN CRISTALPLANT BIOBASED | ENCIMERAS INTEGRADAS DE CRISTALPLANT BIOBASED

H 12,5

ROUND

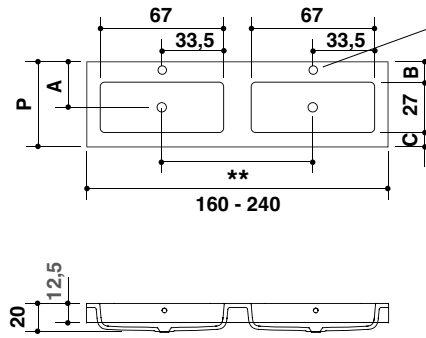
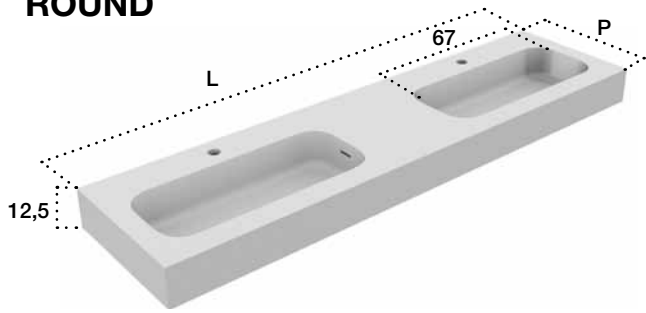

Foro rubinetto a richiesta
Hole drilling on request

Compreso
Free of charge

P	A	B	C
45	23,5	10	8
55	33,5	20	8

Art.	P	L	H
LAQ 160	45	160	12,5
LAQ 180		180	12,5
LAQ 190		190	12,5
LAQ 200		200	12,5
LAQ 220		220	12,5
LAQ 240		240	12,5
LAQ 260		260	12,5
LAQ 280		280	12,5
LAQ 300		300	12,5
<hr/>			
LAR 160	55	160	12,5
LAR 180		180	12,5
LAR 190		190	12,5
LAR 200		200	12,5
LAR 220		220	12,5
LAR 240		240	12,5
LAR 260		260	12,5
LAR 280		280	12,5
LAR 300		300	12,5



P min - max L min - max

35 - 60 160 - 300

Maggiorazione sulla misura superiore / Surcharge on larger size / Aufschlag für größeres Maß / Majoration sur la dimension supérieure / Aumento en la medida superior

Accessori compresi / Included accessories

Accessori suggeriti / suggested accessories

Piletta / Waste Art. 66D	Copri piletta in finitura / Drain cover in finish Cristalplant	Troppo pieno / Overflow Si / Yes	Sifone / Trap 673
-----------------------------	---	-------------------------------------	----------------------



Top compatibile con collezioni / Top compatible with collections:

PURE ELEMENTS - VIAVENETO ELEMENTS - VIAVENETO|G ELEMENTS

D7G Staffa supporto top / Top brackets / Stützbügel für Top / Patte de support / Soporte encimera
fino a cm 90 = n° 2 - da cm 91 a 180 = n° 3 - da cm 181 a 250 = n° 4 - da cm 251 a 300 = n° 5

**Centro lavabo posizionabile su richiesta salvo distanza minima laterale di 6,5 cm / The washbasin center can be positioned on request except for a minimum lateral distance of 6.5 cm / Position der Waschbeckenmitte auf Anfrage, mit seitlichen Mindestabstand von 6,5 cm / Le centre du lavabo peut être positionné à la demande, ad exception d'une distance minimum latérale de 6,5 cm / El centro del lavabo puede ser situado a la solicitud, con una distancia lateral mínima de 6,5 cm.

NOTE **01** **08**

PIANI INTEGRATI IN CRISTALPLANT BIOBASED | CRISTALPLANT BIOBASED BUILT-IN BASINS

| WASCHTISCHE MIT INTEGRIERTEM WASCHBECKEN AUS CRISTALPLANT BIOBASED | PLANS VASQUE INTÉGRÉE EN CRISTALPLANT BIOBASED | ENCIMERAS INTEGRADAS DE CRISTALPLANT BIOBASED

H 1,5

ROUND per base curva / for curved base / für abgerundete basis / pour base courbe / para base curva

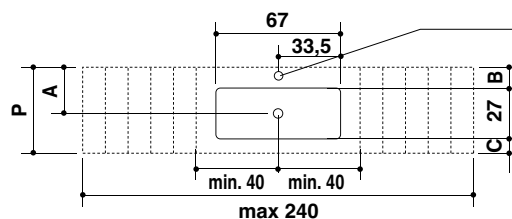
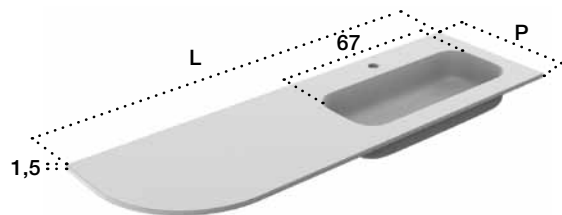

Foro rubinetto a richiesta
Hole drilling on request

Compresso
Free of charge



P	A	B	C
45	23,5	10	8

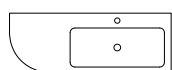

Art. DX / RIGHT

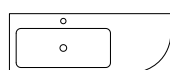

Art. SX / LEFT

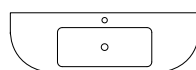

Art. CX / CENTRAL

P L H

D5X 125 DX	D5Y 125 SX		45	125	1,5
D5X 135 DX	D5Y 135 SX			135	1,5
D5X 145 DX	D5Y 145 SX			145	1,5
D5X 165 DX	D5Y 165 SX			165	1,5
D5X 170 DX	D5Y 170 SX	D5Z 170 CX		170	1,5
D5X 180 DX	D5Y 180 SX	D5Z 180 CX		180	1,5
D5X 190 DX	D5Y 190 SX	D5Z 190 CX		190	1,5
D5X 210 DX	D5Y 210 SX	D5Z 210 CX		210	1,5



P min - max L min - max

35 - 45 115 - 210

Maggiorazione sulla misura superiore / Surcharge on larger size / Aufschlag für größeres Maß / Majoration sur la dimension supérieure / Aumento en la medida superior

Accessori compresi / Included accessories

Accessori suggeriti / suggested accessories

Piletta / Waste Art. 66D	Copri piletta in finitura / Drain cover in finish Cristalplant	Troppo pieno / Overflow Sì / Yes
-----------------------------	---	-------------------------------------

Sifone / Trap 673



Top compatibile con collezioni / Top compatible with collections:

PURE ELEMENTS - VIAVENETO ELEMENTS - VIAVENETO|G ELEMENTS

NOTE **01** **08**

PIANI INTEGRATI IN CRISTALPLANT BIOBASED | CRISTALPLANT BIOBASED BUILT-IN BASINS

| WASCHTISCHE MIT INTEGRIERTEM WASCHBECKEN AUS CRISTALPLANT BIOBASED | PLANS VASQUE INTÉGRÉE EN CRISTALPLANT BIOBASED | ENCIMERAS INTEGRADAS DE CRISTALPLANT BIOBASED

H 1,5

SQUARE

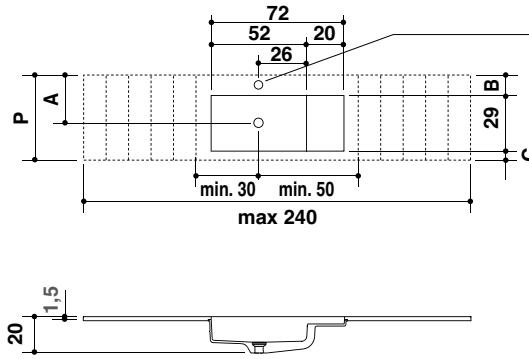
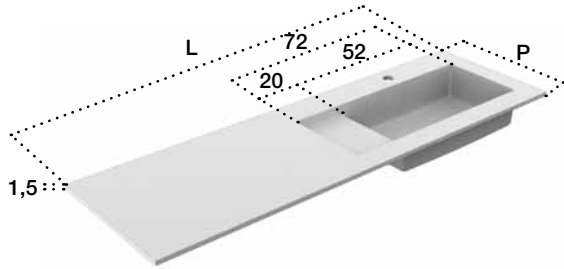

Foro rubinetto a richiesta
Hole drilling on request

Compreso
Free of charge

P	A	B	C
45	24,5	10	6
55	34,5	18	8

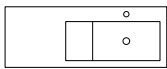

Art. DX / RIGHT

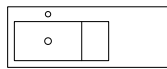

Art. SX / LEFT

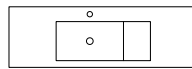

Art. CX / CENTRAL

P L H

P8A 80 DX	P8B 80 SX	P8C 80 CX	45	80	1,5
P8A 90 DX	P8B 90 SX	P8C 90 CX		90	1,5
P8A 100 DX	P8B 100 SX	P8C 100 CX		100	1,5
P8A 110 DX	P8B 110 SX	P8C 110 CX		110	1,5
P8A 120 DX	P8B 120 SX	P8C 120 CX		120	1,5
P8A 130 DX	P8B 130 SX	P8C 130 CX		130	1,5
P8A 140 DX	P8B 140 SX	P8C 140 CX		140	1,5
P8A 150 DX	P8B 150 SX	P8C 150 CX		150	1,5
P8A 160 DX	P8B 160 SX	P8C 160 CX		160	1,5
P8A 170 DX	P8B 170 SX	P8C 170 CX		170	1,5
P8A 180 DX	P8B 180 SX	P8C 180 CX		180	1,5
P8A 190 DX	P8B 190 SX	P8C 190 CX		190	1,5
P8A 200 DX	P8B 200 SX	P8C 200 CX		200	1,5
P8A 220 DX	P8B 220 SX	P8C 220 CX		220	1,5
P8A 240 DX	P8B 240 SX	P8C 240 CX		240	1,5
P8A 260 DX	P8B 260 SX	P8C 260 CX		260	1,5
P8A 280 DX	P8B 280 SX	P8C 280 CX		280	1,5
P8A 300 DX	P8B 300 SX	P8C 300 CX		300	1,5



P min - max L min - max

45 - 60 80 - 300

Maggiorazione sulla misura superiore / Surcharge on larger size / Aufschlag für größeres Maß / Majoration sur la dimension supérieure / Aumento en la medida superior

Accessori compresi / Included accessories

Accessori suggeriti / suggested accessories

Piletta / Waste Art. 66D	Copri piletta in finitura / Drain cover in finish Cristalplant	Troppo pieno / Overflow Sì / Yes
------------------------------------	--	--

Sifone / Trap 673



Top compatibile con collezioni / Top compatible with collections:

PURE ELEMENTS - VIAVENETO ELEMENTS - VIAVENETO|G ELEMENTS

NOTE **01** **08**

PIANI INTEGRATI IN CRISTALPLANT BIOBASED | CRISTALPLANT BIOBASED BUILT-IN BASINS

| WASCHTISCHE MIT INTEGRIERTEM WASCHBECKEN AUS CRISTALPLANT BIOBASED | PLANS VASQUE INTÉGRÉE EN CRISTALPLANT BIOBASED | ENCIMERAS INTEGRADAS DE CRISTALPLANT BIOBASED

H 1,5

SQUARE

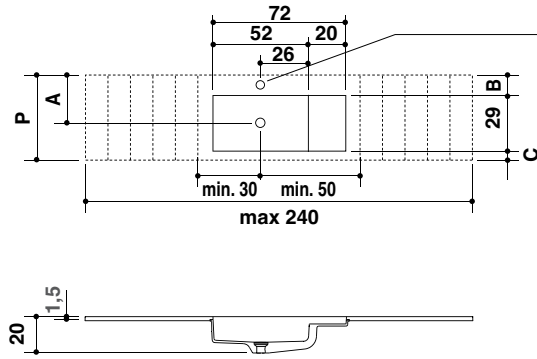
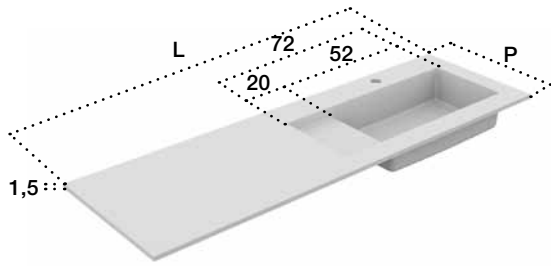

Foro rubinetto a richiesta
Hole drilling on request

Compreso
Free of charge

P	A	B	C
45	24,5	10	6
55	34,5	18	8

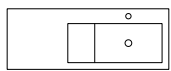

Art. DX / RIGHT

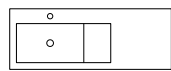

Art. SX / LEFT

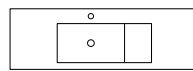

Art. CX / CENTRAL

P L H

P8E 80 DX	P8F 80 SX	P8G 80 CX	55	80	1,5
P8E 90 DX	P8F 90 SX	P8G 90 CX		90	1,5
P8E 100 DX	P8F 100 SX	P8G 100 CX		100	1,5
P8E 110 DX	P8F 110 SX	P8G 110 CX		110	1,5
P8E 120 DX	P8F 120 SX	P8G 120 CX		120	1,5
P8E 130 DX	P8F 130 SX	P8G 130 CX		130	1,5
D8E 140 DX	D8F 140 SX	D8G 140 CX		140	1,5
D8E 150 DX	D8F 150 SX	D8G 150 CX		150	1,5
D8E 160 DX	D8F 160 SX	D8G 160 CX		160	1,5
D8E 170 DX	D8F 170 SX	D8G 170 CX		170	1,5
D8E 180 DX	D8F 180 SX	D8G 180 CX		180	1,5
D8E 190 DX	D8F 190 SX	D8G 190 CX		190	1,5
D8E 200 DX	D8F 200 SX	D8G 200 CX		200	1,5
D8E 220 DX	D8F 220 SX	D8G 220 CX		220	1,5
D8E 240 DX	D8F 240 SX	D8G 240 CX		240	1,5
D8E 260 DX	D8F 260 SX	D8G 260 CX		260	1,5
D8E 280 DX	D8F 280 SX	D8G 280 CX		280	1,5
D8E 300 DX	D8F 300 SX	D8G 300 CX		300	1,5



P min - max L min - max

45 - 60 80 - 300

Maggiorazione sulla misura superiore / Surcharge on larger size / Aufschlag für größeres Maß / Majoration sur la dimension supérieure / Aumento en la medida superior

Accessori compresi / Included accessories

Piletta / Waste Art. 66D	Copri piletta in finitura / Drain cover in finish Cristalplant	Troppo pieno / Overflow Sì / Yes
-----------------------------	---	-------------------------------------

Accessori suggeriti / suggested accessories

Sifone / Trap 673



Top compatibile con collezioni / Top compatible with collections:
PURE ELEMENTS - VIAVENETO ELEMENTS - VIAVENETOJG ELEMENTS

NOTE **01 08**

PIANI INTEGRATI IN CRISTALPLANT BIOBASED | CRISTALPLANT BIOBASED BUILT-IN BASINS

| WASCHTISCHE MIT INTEGRIERTEM WASCHBECKEN AUS CRISTALPLANT BIOBASED | PLANS VASQUE INTÉGRÉE EN CRISTALPLANT BIOBASED | ENCIMERAS INTEGRADAS DE CRISTALPLANT BIOBASED

H 1,5

SQUARE

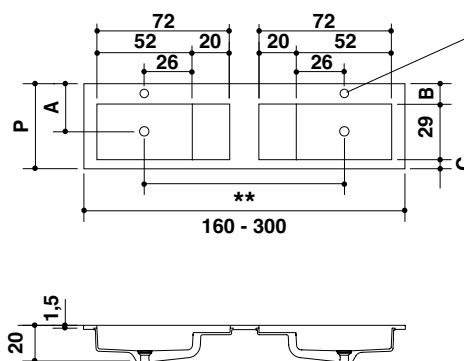
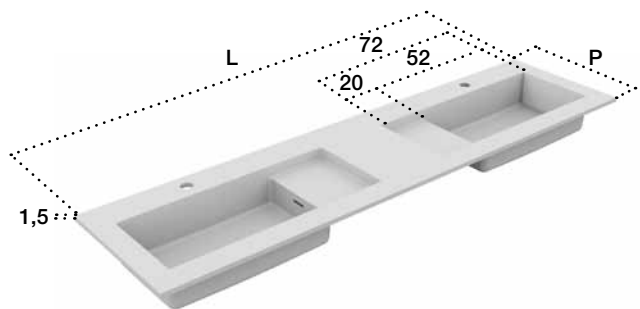

Foro rubinetto a richiesta
Hole drilling on request

Compreso
Free of charge

P	A	B	C
45	24,5	10	6
55	34,5	18	8

Art.	P	L	H
P8D 160	45	160	1,5
P8D 180		180	1,5
P8D 190		190	1,5
P8D 200		200	1,5
P8D 220		220	1,5
P8D 240		240	1,5
P8D 260		260	1,5
P8D 280		280	1,5
P8D 300		300	1,5
<hr/>			
P8H 160	55	160	1,5
P8H 180		180	1,5
P8H 190		190	1,5
P8H 200		200	1,5
P8H 220		220	1,5
P8H 240		240	1,5
P8H 260		260	1,5
P8H 280		280	1,5
P8H 300		300	1,5



P min - max L min - max

45 - 60 160 - 300

Maggiorazione sulla misura superiore / Surcharge on larger size / Aufschlag für größeres Maß / Majoration sur la dimension supérieure / Aumento en la medida superior

Accessori compresi / Included accessories

Accessori suggeriti / suggested accessories

Piletta / Waste Art. 66D	Copri piletta in finitura / Drain cover in finish Cristalplant	Troppo pieno / Overflow Si / Yes	Sifone / Trap 673
-----------------------------	---	-------------------------------------	----------------------



Top compatibile con collezioni / Top compatible with collections:

PURE ELEMENTS - VIAVENETO ELEMENTS - VIAVENETO|G ELEMENTS

**Centro lavabo posizionabile su richiesta salvo distanza minima laterale di 6,5 cm / The washbasin center can be positioned on request except for a minimum lateral distance of 6.5 cm / Position der Waschbeckenmitte auf Anfrage, mit seitlichen Mindestabstand von 6,5 cm / Le centre du lavabo peut être positionné à la demande, ad exception d'une distance minimum latérale de 6,5 cm / El centro del lavabo puede ser situado a la solicitud, con una distancia lateral mínima de 6,5 cm.

NOTE **01** **08**

PIANI INTEGRATI IN CRISTALPLANT BIOBASED | CRISTALPLANT BIOBASED BUILT-IN BASINS

H 12,5

| WASCHTISCHE MIT INTEGRIERTEM WASCHBECKEN AUS CRISTALPLANT BIOBASED | PLANS VASQUE INTÉGRÉE EN CRISTALPLANT BIOBASED | ENCIMERAS INTEGRADAS DE CRISTALPLANT BIOBASED

SQUARE

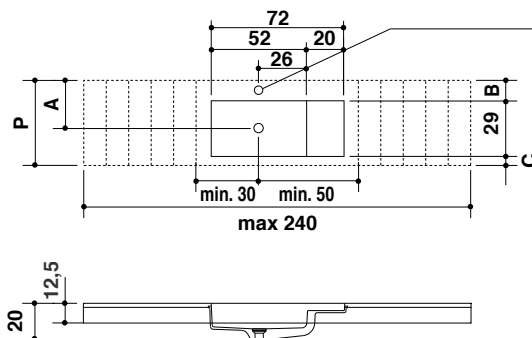
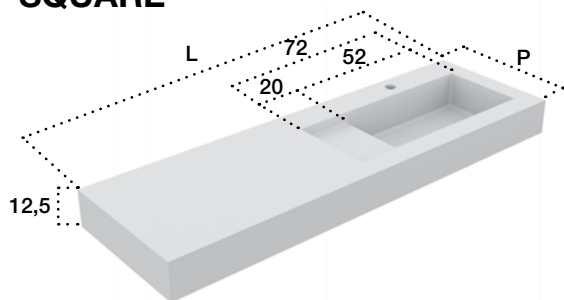

Foro rubinetto a richiesta
Hole drilling on request

Compreso
Free of charge

P	A	B	C
45	24,5	10	6
55	34,5	18	8

Art. DX / RIGHT

Art. SX / LEFT

Art. CX / CENTRAL

P L H

LBJ 80 DX	LBK 80 SX	LBL 80 CX	45	80	12,5
LBJ 90 DX	LBK 90 SX	LBL 90 CX		90	12,5
LBJ 100 DX	LBK 100 SX	LBL 100 CX		100	12,5
LBJ 110 DX	LBK 110 SX	LBL 110 CX		110	12,5
LBJ 120 DX	LBK 120 SX	LBL 120 CX		120	12,5
LBJ 130 DX	LBK 130 SX	LBL 130 CX		130	12,5
LBJ 140 DX	LBK 140 SX	LBL 140 CX		140	12,5
LBJ 150 DX	LBK 150 SX	LBL 150 CX		150	12,5
LBJ 160 DX	LBK 160 SX	LBL 160 CX		160	12,5
LBJ 170 DX	LBK 170 SX	LBL 170 CX		170	12,5
LBJ 180 DX	LBK 180 SX	LBL 180 CX		180	12,5
LBJ 190 DX	LBK 190 SX	LBL 190 CX		190	12,5
LBJ 200 DX	LBK 200 SX	LBL 200 CX		200	12,5
LBJ 220 DX	LBK 220 SX	LBL 220 CX		220	12,5
LBJ 240 DX	LBK 240 SX	LBL 240 CX		240	12,5
LBJ 260 DX	LBK 260 SX	LBL 260 CX		260	12,5
LBJ 280 DX	LBK 280 SX	LBL 280 CX		280	12,5
LBJ 300 DX	LBK 300 SX	LBL 300 CX		300	12,5

LBM 80 DX	LBN 80 SX	LBP 80 CX	55	80	12,5
LBM 90 DX	LBN 90 SX	LBP 90 CX		90	12,5
LBM 100 DX	LBN 100 SX	LBP 100 CX		100	12,5
LBM 110 DX	LBN 110 SX	LBP 110 CX		110	12,5
LBM 120 DX	LBN 120 SX	LBP 120 CX		120	12,5
LBM 130 DX	LBN 130 SX	LBP 130 CX		130	12,5
LBM 140 DX	LBN 140 SX	LBP 140 CX		140	12,5
LBM 150 DX	LBN 150 SX	LBP 150 CX		150	12,5
LBM 160 DX	LBN 160 SX	LBP 160 CX		160	12,5
LBM 170 DX	LBN 170 SX	LBP 170 CX		170	12,5
LBM 180 DX	LBN 180 SX	LBP 180 CX		180	12,5
LBM 190 DX	LBN 190 SX	LBP 190 CX		190	12,5
LBM 200 DX	LBN 200 SX	LBP 200 CX		200	12,5
LBM 220 DX	LBN 220 SX	LBP 220 CX		220	12,5
LBM 240 DX	LBN 240 SX	LBP 240 CX		240	12,5
LBM 260 DX	LBN 260 SX	LBP 260 CX		260	12,5
LBM 280 DX	LBN 280 SX	LBP 280 CX		280	12,5
LBM 300 DX	LBN 300 SX	LBP 300 CX		300	12,5



P min - max L min - max

45 - 60 80 - 300

Maggiorazione sulla misura superiore / Surcharge on larger size / Aufschlag für größeres Maß / Majoration sur la dimension supérieure / Aumento en la medida superior

Accessori compresi / Included accessories

Accessori suggeriti / suggested accessories

Piletta / Waste Art. 66D	Copri piletta in finitura / Drain cover in finish Cristalplant	Troppo pieno / Overflow Si / Yes
------------------------------------	--	--

Sifone / Trap 673



Top compatibile con collezioni / Top compatible with collections:

PURE ELEMENTS - VIAVENETO ELEMENTS - VIAVENETO|G ELEMENTS

D7G

Staffa supporto top / Top brackets / Stützbügel für Top / Patte de support / Soporte encimera
fino a cm 90 = n° 2 - da cm 91 a 180 = n° 3 - da cm 181 a 250 = n° 4 - da cm 251 a 300 = n° 5

NOTE

01 08

PIANI INTEGRATI IN CRISTALPLANT BIOBASED | CRISTALPLANT BIOBASED BUILT-IN BASINS

| WASCHTISCHE MIT INTEGRIERTEM WASCHBECKEN AUS CRISTALPLANT BIOBASED | PLANS VASQUE INTÉGRÉE EN CRISTALPLANT BIOBASED | ENCIMERAS INTEGRADAS DE CRISTALPLANT BIOBASED

H 12,5

SQUARE

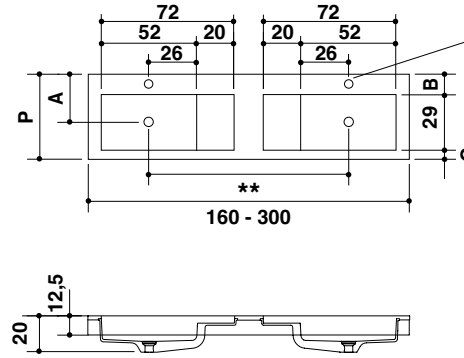
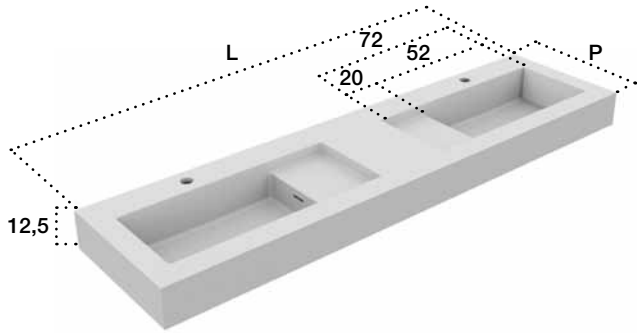

Foro rubinetto a richiesta
Hole drilling on request

Compreso
Free of charge

P	A	B	C
45	24,5	10	6
55	34,5	18	8

Art.	P	L	H
LBQ 160	45	160	12,5
LBQ 180		180	12,5
LBQ 190		190	12,5
LBQ 200		200	12,5
LBQ 220		220	12,5
LBQ 240		240	12,5
LBQ 260		260	12,5
LBQ 280		280	12,5
LBQ 300		300	12,5
<hr/>			
LBR 160	55	160	12,5
LBR 180		180	12,5
LBR 190		190	12,5
LBR 200		200	12,5
LBR 220		220	12,5
LBR 240		240	12,5
LBR 260		260	12,5
LBR 280		280	12,5
LBR 300		300	12,5



P min - max L min - max

45 - 60 160 - 300

Maggiorazione sulla misura superiore / Surcharge on larger size / Aufschlag für größeres Maß / Majoration sur la dimension supérieure / Aumento en la medida superior

Accessori compresi / Included accessories

Accessori suggeriti / suggested accessories

Piletta / Waste Art. 66D	Copri piletta in finitura / Drain cover in finish Cristalplant	Troppo pieno / Overflow Si / Yes
-----------------------------	---	-------------------------------------

Sifone / Trap 673



Top compatibile con collezioni / Top compatible with collections:

PURE ELEMENTS - VIAVENETO ELEMENTS - VIAVENETO|G ELEMENTS

D7G Staffa supporto top / Top brackets / Stützbügel für Top / Patte de support / Soporte encimera
fino a cm 90 = n° 2 - da cm 91 a 180 = n° 3 - da cm 181 a 250 = n° 4 - da cm 251 a 300 = n° 5

**Centro lavabo posizionabile su richiesta salvo distanza minima laterale di 6,5 cm / The washbasin center can be positioned on request except for a minimum lateral distance of 6.5 cm / Position der Waschbeckenmitte auf Anfrage, mit seitlichen Mindestabstand von 6,5 cm / Le centre du lavabo peut être positionné à la demande, ad exception d'une distance minimum latérale de 6,5 cm / El centro del lavabo puede ser situado a la solicitud, con una distancia lateral mínima de 6,5 cm.

NOTE **01** **08**

PIANI INTEGRATI IN CRISTALPLANT BIOBASED | CRISTALPLANT BIOBASED BUILT-IN BASINS

| WASCHTISCHE MIT INTEGRIERTEM WASCHBECKEN AUS CRISTALPLANT BIOBASED | PLANS VASQUE INTÉGRÉE EN CRISTALPLANT BIOBASED | ENCIMERAS INTEGRADAS DE CRISTALPLANT BIOBASED

H 1,5

EXTREME FLAT

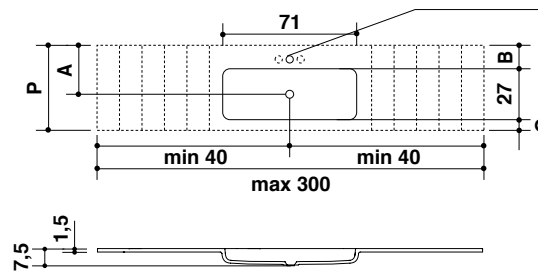
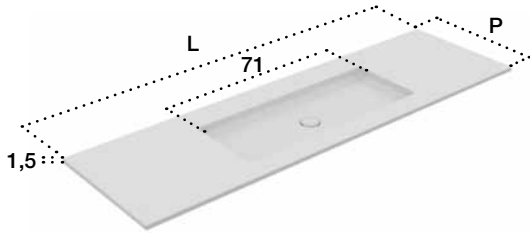

Foro rubinetto a richiesta
Hole drilling on request

Compreso
Free of charge

P	A	B	C
45	24	10	8
55	34	20	8

Art. DX / RIGHT	Art. SX / LEFT	Art. CX / CENTRAL	P	L	H	
LCA 90 DX	LCB 90 SX	LCC 80 CX	45	80	1,5	
LCA 100 DX	LCB 100 SX	LCC 90 CX		90	1,5	
LCA 110 DX	LCB 110 SX	LCC 100 CX		100	1,5	
LCA 120 DX	LCB 120 SX	LCC 110 CX		110	1,5	
LCA 130 DX	LCB 130 SX	LCC 120 CX		120	1,5	
LCA 140 DX	LCB 140 SX	LCC 130 CX		130	1,5	
LCA 150 DX	LCB 150 SX	LCC 140 CX		140	1,5	
LCA 160 DX	LCB 160 SX	LCC 150 CX		150	1,5	
LCA 170 DX	LCB 170 SX	LCC 160 CX		160	1,5	
LCA 180 DX	LCB 180 SX	LCC 170 CX		170	1,5	
LCA 190 DX	LCB 190 SX	LCC 180 CX		180	1,5	
LCA 200 DX	LCB 200 SX	LCC 190 CX		190	1,5	
LCA 220 DX	LCB 220 SX	LCC 200 CX		200	1,5	
LCA 240 DX	LCB 240 SX	LCC 220 CX		220	1,5	
LCA 260 DX	LCB 260 SX	LCC 240 CX		240	1,5	
LCA 280 DX	LCB 280 SX	LCC 260 CX		260	1,5	
LCA 300 DX	LCB 300 SX	LCC 280 CX		280	1,5	
		LCC 300 CX		300	1,5	
LCD 90 DX	LCE 90 SX	LCF 80 CX		55	80	1,5
LCD 100 DX	LCE 100 SX	LCF 90 CX			90	1,5
LCD 110 DX	LCE 110 SX	LCF 100 CX	100		1,5	
LCD 120 DX	LCE 120 SX	LCF 110 CX	110		1,5	
LCD 130 DX	LCE 130 SX	LCF 120 CX	120		1,5	
LCD 140 DX	LCE 140 SX	LCF 130 CX	130		1,5	
LCD 150 DX	LCE 150 SX	LCF 140 CX	140		1,5	
LCD 160 DX	LCE 160 SX	LCF 150 CX	150		1,5	
LCD 170 DX	LCE 170 SX	LCF 160 CX	160		1,5	
LCD 180 DX	LCE 180 SX	LCF 170 CX	170		1,5	
LCD 190 DX	LCE 190 SX	LCF 180 CX	180		1,5	
LCD 200 DX	LCE 200 SX	LCF 190 CX	190		1,5	
LCD 220 DX	LCE 220 SX	LCF 200 CX	200		1,5	
LCD 240 DX	LCE 240 SX	LCF 220 CX	220		1,5	
LCD 260 DX	LCE 260 SX	LCF 240 CX	240		1,5	
LCD 280 DX	LCE 280 SX	LCF 260 CX	260		1,5	
LCD 300 DX	LCE 300 SX	LCF 280 CX	280		1,5	
		LCF 300 CX	300		1,5	



P min - max L min - max

45 - 55 80 - 300

Maggiorazione sulla misura superiore / Surcharge on larger size / Aufschlag für größeres Maß / Majoration sur la dimension supérieure / Aumento en la medida superior

Accessori compresi / Included accessories

Accessori suggeriti / suggested accessories

Piletta / Waste Art. 66A	Copri piletta in finitura / Drain cover in finish Cristalplant	Troppo pieno / Overflow No
-----------------------------	---	-------------------------------

Sifone / Trap 673



Top compatibile con collezioni / Top compatible with collections:
PURE ELEMENTS - VIAVENETO ELEMENTS - VIAVENETO|G ELEMENTS

NOTE **01 08**

PIANI INTEGRATI IN CRISTALPLANT BIOBASED | CRISTALPLANT BIOBASED BUILT-IN BASINS

| WASCHTISCHE MIT INTEGRIERTEM WASCHBECKEN AUS CRISTALPLANT BIOBASED | PLANS VASQUE INTÉGRÉE EN CRISTALPLANT BIOBASED | ENCIMERAS INTEGRADAS DE CRISTALPLANT BIOBASED

H 1,5

EXTREME FLAT

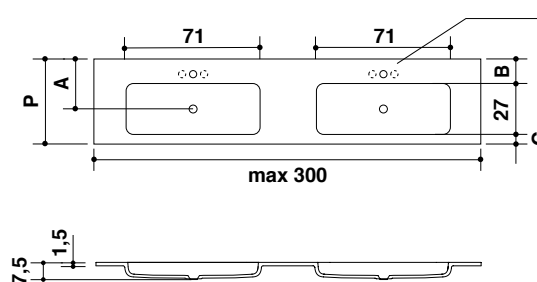
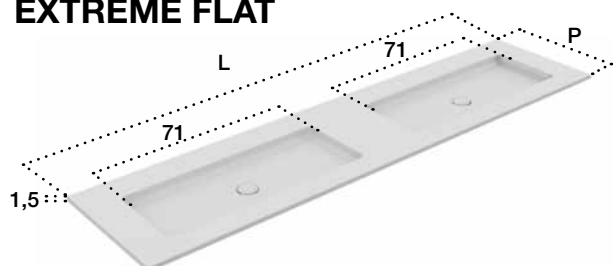

Foro rubinetto a richiesta
Hole drilling on request

Compresso
Free of charge

P	A	B	C
45	24	10	8
55	34	20	8

Art.	P	L	H
LCG 160	45	160	1,5
LCG 180		180	1,5
LCG 190		190	1,5
LCG 200		200	1,5
LCG 220		220	1,5
LCG 240		240	1,5
LCG 260		260	1,5
LCG 280		280	1,5
LCG 300		300	1,5

LCH 160	55	160	1,5
LCH 180		180	1,5
LCH 190		190	1,5
LCH 200		200	1,5
LCH 220		220	1,5
LCH 240		240	1,5
LCH 260		260	1,5
LCH 280		280	1,5
LCH 300		300	1,5



P min - max L min - max

45 - 55 160 - 300

Maggiorazione sulla misura superiore / Surcharge on larger size / Aufschlag für größeres Maß / Majoration sur la dimension supérieure / Aumento en la medida superior

Accessori compresi / Included accessories

Accessori suggeriti / suggested accessories

Piletta / Waste Art. 66A	Copri piletta in finitura / Drain cover in finish Cristalplant	Troppo pieno / Overflow No
-----------------------------	---	-------------------------------

Sifone / Trap 673



Top compatibile con collezioni / Top compatible with collections:

PURE ELEMENTS - VIAVENETO ELEMENTS - VIAVENETO|G ELEMENTS

**Centro lavabo posizionabile su richiesta salvo distanza minima laterale di 4,5 cm / The washbasin center can be positioned on request except for a minimum lateral distance of 4.5 cm / Position der Waschbeckenmitte auf Anfrage, mit seitlichen Mindestabstand von 4,5 cm / Le centre du lavabo peut être positionné à la demande, ad exception d'une distance minimum latérale de 4,5 cm / El centro del lavabo puede ser situado a la solicitud, con una distancia lateral mínima de 4,5 cm.

NOTE **01** **08**

PIANI INTEGRATI IN CRISTALPLANT BIOBASED | CRISTALPLANT BIOBASED BUILT-IN BASINS

| WASCHTISCHE MIT INTEGRIERTEM WASCHBECKEN AUS CRISTALPLANT BIOBASED | PLANS VASQUE INTÉGRÉE EN CRISTALPLANT BIOBASED | ENCIMERAS INTEGRADAS DE CRISTALPLANT BIOBASED

H 12,5

EXTREME FLAT

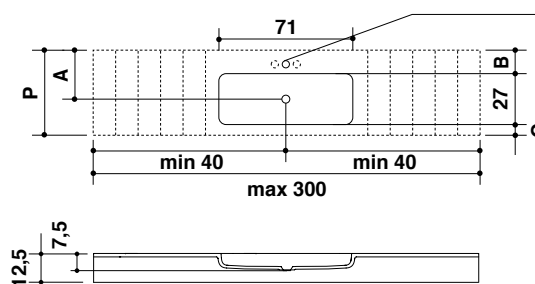
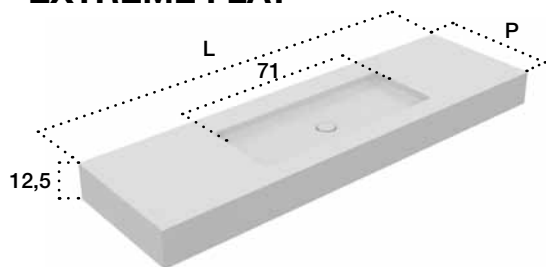

Foro rubinetto a richiesta
Hole drilling on request

Compreso
Free of charge

P	A	B	C
45	24	10	8
55	34	20	8

Art. DX / RIGHT

Art. SX / LEFT

Art. CX / CENTRAL

P L H

LCS 90 DX	LCT 90 SX	LCU 80 CX	45	80	1,5
LCS 100 DX	LCT 100 SX	LCU 90 CX		90	1,5
LCS 110 DX	LCT 110 SX	LCU 100 CX		100	1,5
LCS 120 DX	LCT 120 SX	LCU 110 CX		110	1,5
LCS 130 DX	LCT 130 SX	LCU 120 CX		120	1,5
LCS 140 DX	LCT 140 SX	LCU 130 CX		130	1,5
LCS 140 DX	LCT 140 SX	LCU 140 CX		140	1,5
LCS 150 DX	LCT 150 SX	LCU 150 CX		150	1,5
LCS 160 DX	LCT 160 SX	LCU 160 CX		160	1,5
LCS 170 DX	LCT 170 SX	LCU 170 CX		170	1,5
LCS 180 DX	LCT 180 SX	LCU 180 CX		180	1,5
LCS 190 DX	LCT 190 SX	LCU 190 CX		190	1,5
LCS 200 DX	LCT 200 SX	LCU 200 CX		200	1,5
LCS 220 DX	LCT 220 SX	LCU 220 CX		220	1,5
LCS 240 DX	LCT 240 SX	LCU 240 CX		240	1,5
LCS 260 DX	LCT 260 SX	LCU 260 CX		260	1,5
LCS 280 DX	LCT 280 SX	LCU 280 CX		280	1,5
LCS 300 DX	LCT 300 SX	LCU 300 CX		300	1,5

LCV 90 DX	LCW 90 SX	LCX 80 CX	55	80	1,5
LCV 100 DX	LCW 100 SX	LCX 90 CX		90	1,5
LCV 110 DX	LCW 110 SX	LCX 100 CX		100	1,5
LCV 120 DX	LCW 120 SX	LCX 110 CX		110	1,5
LCV 130 DX	LCW 130 SX	LCX 120 CX		120	1,5
LCV 140 DX	LCW 140 SX	LCX 130 CX		130	1,5
LCV 140 DX	LCW 140 SX	LCX 140 CX		140	1,5
LCV 150 DX	LCW 150 SX	LCX 150 CX		150	1,5
LCV 160 DX	LCW 160 SX	LCX 160 CX		160	1,5
LCV 170 DX	LCW 170 SX	LCX 170 CX		170	1,5
LCV 180 DX	LCW 180 SX	LCX 180 CX		180	1,5
LCV 190 DX	LCW 190 SX	LCX 190 CX		190	1,5
LCV 200 DX	LCW 200 SX	LCX 200 CX		200	1,5
LCV 220 DX	LCW 220 SX	LCX 220 CX		220	1,5
LCV 240 DX	LCW 240 SX	LCX 240 CX		240	1,5
LCV 260 DX	LCW 260 SX	LCX 260 CX		260	1,5
LCV 280 DX	LCW 280 SX	LCX 280 CX		280	1,5
LCV 300 DX	LCW 300 SX	LCX 300 CX		300	1,5



P min - max L min - max

45 - 55 80 - 300

Maggiorazione sulla misura superiore / Surcharge on larger size / Aufschlag für größeres Maß / Majoration sur la dimension supérieure / Aumento en la medida superior

Accessori compresi / Included accessories

Accessori suggeriti / suggested accessories

Piletta / Waste Art. 66A	Copri piletta in finitura / Drain cover in finish Cristalplant	Troppo pieno / Overflow No
-----------------------------	---	-------------------------------

Sifone / Trap 673



Top compatibile con collezioni / Top compatible with collections:

PURE ELEMENTS - VIAVENETO ELEMENTS - VIAVENETO|G ELEMENTS

D7G

Staffa supporto top / Top brackets / Stützbügel für Top / Patte de support / Soporte encimera
fino a cm 90 = n° 2 - da cm 91 a 180 = n° 3 - da cm 181 a 250 = n° 4 - da cm 251 a 300 = n° 5

NOTE

01 08

PIANI INTEGRATI IN CRISTALPLANT BIOBASED | CRISTALPLANT BIOBASED BUILT-IN BASINS

| WASCHTISCHE MIT INTEGRIERTEM WASCHBECKEN AUS CRISTALPLANT BIOBASED | PLANS VASQUE INTÉGRÉE EN CRISTALPLANT BIOBASED | ENCIMERAS INTEGRADAS DE CRISTALPLANT BIOBASED

H 12,5

EXTREME FLAT

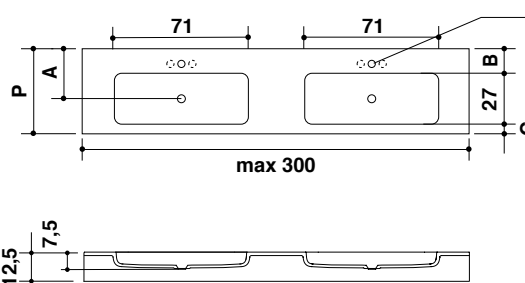
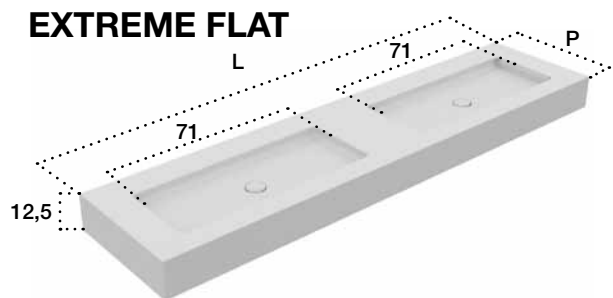

Foro rubinetto a richiesta
Hole drilling on request

Compreso
Free of charge

P	A	B	C
45	24	10	8
55	34	20	8

Art. P L H

LCY 160	45	160	1,5
LCY 180		180	1,5
LCY 190		190	1,5
LCY 200		200	1,5
LCY 220		220	1,5
LCY 240		240	1,5
LCY 260		260	1,5
LCY 280		280	1,5
LCY 300		300	1,5

LCZ 160	55	160	1,5
LCZ 180		180	1,5
LCZ 190		190	1,5
LCZ 200		200	1,5
LCZ 220		220	1,5
LCZ 240		240	1,5
LCZ 260		260	1,5
LCZ 280		280	1,5
LCZ 300		300	1,5



P min - max L min - max

45 - 55 160 - 300

Maggiorazione sulla misura superiore / Surcharge on larger size / Aufschlag für größeres Maß / Majoration sur la dimension supérieure / Aumento en la medida superior

Accessori compresi / Included accessories

Accessori suggeriti / suggested accessories

Piletta / Waste Art. 66A	Copri piletta in finitura / Drain cover in finish Cristalplant	Troppo pieno / Overflow No	Sifone / Trap 673
-----------------------------	---	-------------------------------	----------------------



Top compatibile con collezioni / Top compatible with collections:

PURE ELEMENTS - VIAVENETO ELEMENTS - VIAVENETO|G ELEMENTS

D7G

Staffa supporto top / Top brackets / Stützbügel für Top / Patte de support / Soporte encimera
fino a cm 90 = n° 2 - da cm 91 a 180 = n° 3 - da cm 181 a 250 = n° 4 - da cm 251 a 300 = n° 5

**Centro lavabo posizionabile su richiesta salvo distanza minima laterale di 4,5 cm / The washbasin center can be positioned on request except for a minimum lateral distance of 4.5 cm / Position der Waschbeckenmitte auf Anfrage, mit seitlichen Mindestabstand von 4,5 cm / Le centre du lavabo peut être positionné à la demande, ad exception d'une distance minimum latérale de 4,5 cm / El centro del lavabo puede ser situado a la solicitud, con una distancia lateral mínima de 4,5 cm.

NOTE **01** **08**

FLAT SOFT

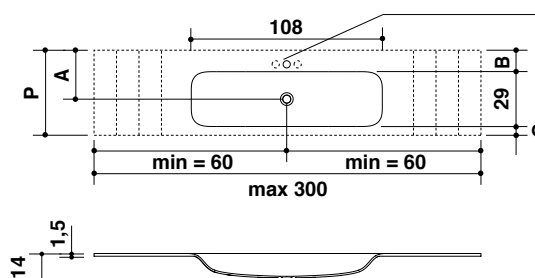
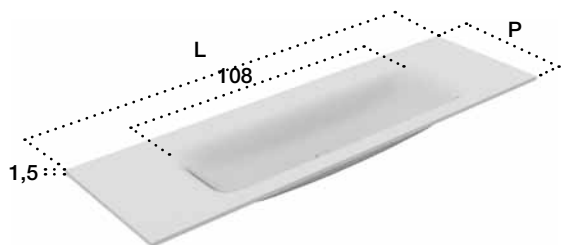

Foro rubinetto a richiesta
Hole drilling on request

Compreso
Free of charge

P	A	B	C
45	25	9	5
55	35	19	5

Art. DX / RIGHT	Art. SX / LEFT	Art. CX / CENTRAL	P	L	H
		LDL 120 CX	45	120	1,5
LDJ 130 DX	LDK 130 SX	LDL 130 CX		130	1,5
LDJ 140 DX	LDK 140 SX	LDL 140 CX		140	1,5
LDJ 150 DX	LDK 150 SX	LDL 150 CX		150	1,5
LDJ 160 DX	LDK 160 SX	LDL 160 CX		160	1,5
LDJ 170 DX	LDK 170 SX	LDL 170 CX		170	1,5
LDJ 180 DX	LDK 180 SX	LDL 180 CX		180	1,5
LDJ 190 DX	LDK 190 SX	LDL 190 CX		190	1,5
LDJ 200 DX	LDK 200 SX	LDL 200 CX		200	1,5
LDJ 220 DX	LDK 220 SX	LDL 220 CX		220	1,5
LDJ 240 DX	LDK 240 SX	LDL 240 CX		240	1,5
LDJ 260 DX	LDK 260 SX	LDL 260 CX		260	1,5
LDJ 280 DX	LDK 280 SX	LDL 280 CX		280	1,5
LDJ 300 DX	LDK 300 SX	LDL 300 CX		300	1,5
		LDP 120 CX	55	120	1,5
LDM 130 DX	LDN 130 SX	LDP 130 CX		130	1,5
LDM 140 DX	LDN 140 SX	LDP 140 CX		140	1,5
LDM 150 DX	LDN 150 SX	LDP 150 CX		150	1,5
LDM 160 DX	LDN 160 SX	LDP 160 CX		160	1,5
LDM 170 DX	LDN 170 SX	LDP 170 CX		170	1,5
LDM 180 DX	LDN 180 SX	LDP 180 CX		180	1,5
LDM 190 DX	LDN 190 SX	LDP 190 CX		190	1,5
LDM 200 DX	LDN 200 SX	LDP 200 CX		200	1,5
LDM 220 DX	LDN 220 SX	LDP 220 CX		220	1,5
LDM 240 DX	LDN 240 SX	LDP 240 CX		240	1,5
LDM 260 DX	LDN 260 SX	LDP 260 CX		260	1,5
LDM 280 DX	LDN 280 SX	LDP 280 CX		280	1,5
LDM 300 DX	LDN 300 SX	LDP 300 CX		300	1,5



P min - max L min - max

45 - 55 120 - 300

Maggiorazione sulla misura superiore / Surcharge on larger size / Aufschlag für größeres Maß / Majoration sur la dimension supérieure / Aumento en la medida superior

Accessori compresi / Included accessories

Accessori suggeriti / suggested accessories

Piletta / Waste Art. 66A	Copri piletta in finitura / Drain cover in finish Cristalplant	Troppo pieno / Overflow No	Sifone / Trap 673
-----------------------------	---	-------------------------------	----------------------



Top compatibile con collezioni / Top compatible with collections:

PURE ELEMENTS - VIAVENETO ELEMENTS - VIAVENETO|G ELEMENTS

68J

Kit foro e scarico troppo pieno a richiesta con piletta Push / Hole and drain overflow kit upon request with Push waste / Überlaufsatz auf Anfrage mit Druckablaufventil / Kit trou et vidage trop plein sur demande avec bonde a pression / Kit orificio y descarga rebosadero bajo pedido con rejilla a pression

NOTE **01 08**

PIANI INTEGRATI IN CRISTALPLANT BIOBASED | CRISTALPLANT BIOBASED BUILT-IN BASINS

| WASCHTISCHE MIT INTEGRIERTEM WASCHBECKEN AUS CRISTALPLANT BIOBASED | PLANS VASQUE INTÉGRÉE EN CRISTALPLANT BIOBASED | ENCIMERAS INTEGRADAS DE CRISTALPLANT BIOBASED

H 12,5

FLAT SOFT

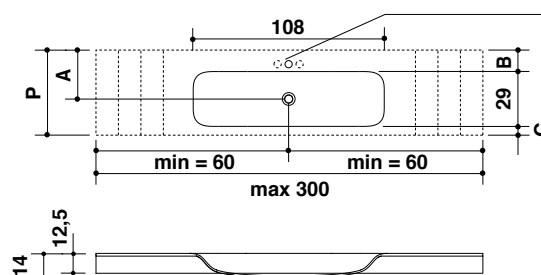
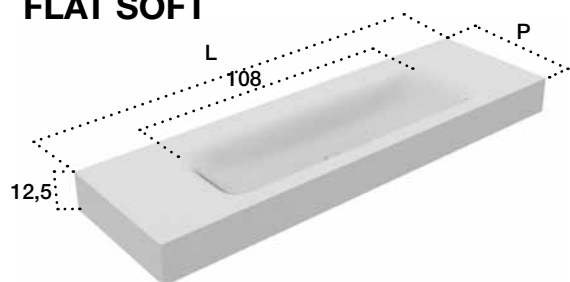

Foro rubinetto a richiesta
Hole drilling on request

Compreso
Free of charge

P	A	B	C
45	25	9	5
55	35	19	5

Art. DX / RIGHT

Art. SX / LEFT

Art. CX / CENTRAL

P L H

		LDY 120 CX	45	120	12,5
LDW 130 DX	LDX 130 SX	LDY 130 CX		130	12,5
LDW 140 DX	LDX 140 SX	LDY 140 CX		140	12,5
LDW 150 DX	LDX 150 SX	LDY 150 CX		150	12,5
LDW 160 DX	LDX 160 SX	LDY 160 CX		160	12,5
LDW 170 DX	LDX 170 SX	LDY 170 CX		170	12,5
LDW 180 DX	LDX 180 SX	LDY 180 CX		180	12,5
LDW 190 DX	LDX 190 SX	LDY 190 CX		190	12,5
LDW 200 DX	LDX 200 SX	LDY 200 CX		200	12,5
LDW 220 DX	LDX 220 SX	LDY 220 CX		220	12,5
LDW 240 DX	LDX 240 SX	LDY 240 CX		240	12,5
LDW 260 DX	LDX 260 SX	LDY 260 CX		260	12,5
LDW 280 DX	LDX 280 SX	LDY 280 CX		280	12,5
LDW 300 DX	LDX 300 SX	LDY 300 CX		300	12,5

		LEB 120 CX	55	120	12,5
LDZ 130 DX	LEA 130 SX	LEB 130 CX		130	12,5
LDZ 140 DX	LEA 140 SX	LEB 140 CX		140	12,5
LDZ 150 DX	LEA 150 SX	LEB 150 CX		150	12,5
LDZ 160 DX	LEA 160 SX	LEB 160 CX		160	12,5
LDZ 170 DX	LEA 170 SX	LEB 170 CX		170	12,5
LDZ 180 DX	LEA 180 SX	LEB 180 CX		180	12,5
LDZ 190 DX	LEA 190 SX	LEB 190 CX		190	12,5
LDZ 200 DX	LEA 200 SX	LEB 200 CX		200	12,5
LDZ 220 DX	LEA 220 SX	LEB 220 CX		220	12,5
LDZ 240 DX	LEA 240 SX	LEB 240 CX		240	12,5
LDZ 260 DX	LEA 260 SX	LEB 260 CX		260	12,5
LDZ 280 DX	LEA 280 SX	LEB 280 CX		280	12,5
LDZ 300 DX	LEA 300 SX	LEB 300 CX		300	12,5



P min - max L min - max

45 - 55 120 - 300

Maggiorazione sulla misura superiore / Surcharge on larger size / Aufschlag für größeres Maß / Majoration sur la dimension supérieure / Aumento en la medida superior

Accessori compresi / Included accessories

Accessori suggeriti / suggested accessories

Piletta / Waste Art. 66A	Copri piletta in finitura / Drain cover in finish Cristalplant	Troppo pieno / Overflow No	Sifone / Trap 673
------------------------------------	--	--------------------------------------	-----------------------------



Top compatibile con collezioni / Top compatible with collections:

PURE ELEMENTS - VIAVENETO ELEMENTS - VIAVENETO|G ELEMENTS

68J	Kit foro e scarico troppo pieno a richiesta con piletta Push / Hole and drain overflow kit upon request with Push waste / Überlaufsaufsatz auf Anfrage mit Druckablaufventil / Kit trou et vidage trop plein sur demande avec bonde a pression / Kit orificio y descarga rebosadero bajo pedido con rejilla a pression
D7G	Staffa supporto top / Top brackets / Stützbügel für Top / Patte de support / Soporte encimera fino a cm 90 = n° 2 - da cm 91 a 180 = n° 3 - da cm 181 a 250 = n° 4 - da cm 251 a 300 = n° 5

NOTE **01** **08**

ARC

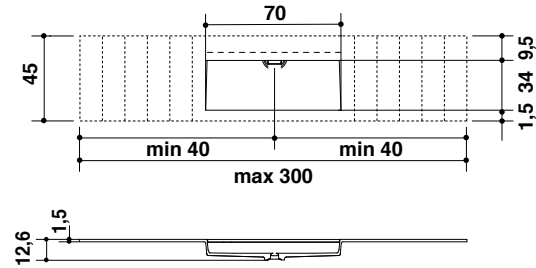
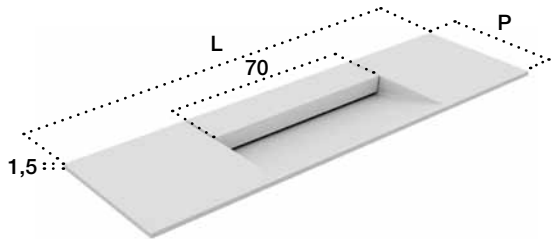

Art. DX / RIGHT	Art. SX / LEFT	Art. CX / CENTRAL	P	L	H
		LHC 80 CX	45	80	1,5
LHA 90 DX	LHB 90 SX	LHC 90 CX		90	1,5
LHA 100 DX	LHB 100 SX	LHC 100 CX		100	1,5
LHA 110 DX	LHB 110 SX	LHC 110 CX		110	1,5
LHA 120 DX	LHB 120 SX	LHC 120 CX		120	1,5
LHA 130 DX	LHB 130 SX	LHC 130 CX		130	1,5
LHA 140 DX	LHB 140 SX	LHC 140 CX		140	1,5
LHA 150 DX	LHB 150 SX	LHC 150 CX		150	1,5
LHA 160 DX	LHB 160 SX	LHC 160 CX		160	1,5
LHA 170 DX	LHB 170 SX	LHC 170 CX		170	1,5
LHA 180 DX	LHB 180 SX	LHC 180 CX		180	1,5
LHA 190 DX	LHB 190 SX	LHC 190 CX		190	1,5
LHA 200 DX	LHB 200 SX	LHC 200 CX		200	1,5
LHA 220 DX	LHB 220 SX	LHC 220 CX		220	1,5
LHA 240 DX	LHB 240 SX	LHC 240 CX		240	1,5
LHA 260 DX	LHB 260 SX	LHC 260 CX		260	1,5
LHA 280 DX	LHB 280 SX	LHC 280 CX		280	1,5
LHA 300 DX	LHB 300 SX	LHC 300 CX		300	1,5



L min - max

80 - 300

Maggiorazione sulla misura superiore / Surcharge on larger size / Aufschlag für größeres Maß / Majoration sur la dimension supérieure / Aumento en la medida superior

Accessori compresi / Included accessories

Piletta / Waste Inclusa / Included	Copri piletta in finitura / Drain cover in finish Cristalplant	Troppo pieno / Overflow No
---------------------------------------	---	-------------------------------

Accessori suggeriti / suggested accessories

Sifone / Trap 673



Top compatibile con collezioni / Top compatible with collections:

PURE ELEMENTS - VIAVENETO ELEMENTS - VIAVENETO|G ELEMENTS

NOTE 01 08

PIANI INTEGRATI IN CRISTALPLANT BIOBASED | CRISTALPLANT BIOBASED BUILT-IN BASINS

| WASCHTISCHE MIT INTEGRIERTEM WASCHBECKEN AUS CRISTALPLANT BIOBASED | PLANS VASQUE INTÉGRÉE EN CRISTALPLANT BIOBASED | ENCIMERAS INTEGRADAS DE CRISTALPLANT BIOBASED

H 1,5

ARC

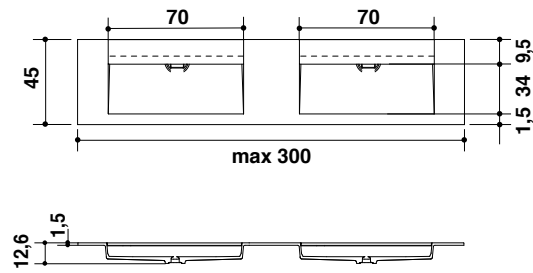
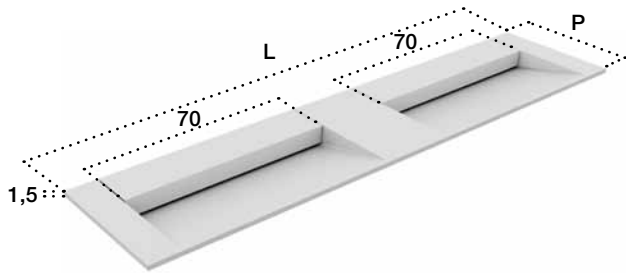

Art.	P	L	H
LHD 160	45	160	1,5
LHD 180		180	1,5
LHD 190		190	1,5
LHD 200		200	1,5
LHD 220		220	1,5
LHD 240		240	1,5
LHD 260		260	1,5
LHD 280		280	1,5
LHD 300		300	1,5



L min - max

160 - 300

Maggiorazione sulla misura superiore / Surcharge on larger size / Aufschlag für größeres Maß / Majoration sur la dimension supérieure / Aumento en la medida superior

Accessori compresi / Included accessories

Accessori suggeriti / suggested accessories

Piletta / Waste Inclusa / Included	Copri piletta in finitura / Drain cover in finish Cristalplant	Troppo pieno / Overflow No
---------------------------------------	---	-------------------------------

Sifone / Trap 673



Top compatibile con collezioni / Top compatible with collections:

PURE ELEMENTS - VIAVENETO ELEMENTS - VIAVENETO|G ELEMENTS

****Centro lavabo posizionabile su richiesta salvo distanza minima laterale di 6,5 cm / The washbasin center can be positioned on request except for a minimum lateral distance of 6.5 cm / Position der Waschbeckenmitte auf Anfrage, mit seitlichen Mindestabstand von 6,5 cm / Le centre du lavabo peut être positionné à la demande, ad exception d'une distance minimum latérale de 6,5 cm / El centro del lavabo puede ser situado a la solicitud, con una distancia lateral mínima de 6,5 cm.**

NOTE **01** **08**

PIANI INTEGRATI IN CRISTALPLANT BIOBASED | CRISTALPLANT BIOBASED BUILT-IN BASINS

| WASCHTISCHE MIT INTEGRIERTEM WASCHBECKEN AUS CRISTALPLANT BIOBASED | PLANS VASQUE INTÉGRÉE EN CRISTALPLANT BIOBASED | ENCIMERAS INTEGRADAS DE CRISTALPLANT BIOBASED

H 12,5

ARC

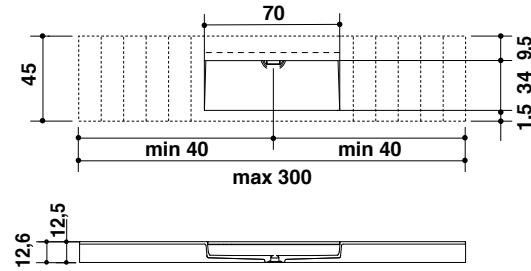
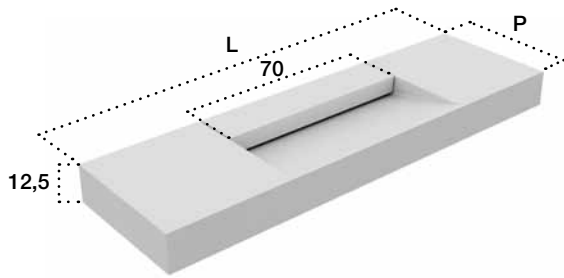

Art. DX / RIGHT	Art. SX / LEFT	Art. CX / CENTRAL	P	L	H
		LHL 80 CX	45	80	12,5
LHJ 90 DX	LHK 90 SX	LHL 90 CX		90	12,5
LHJ 100 DX	LHK 100 SX	LHL 100 CX		100	12,5
LHJ 110 DX	LHK 110 SX	LHL 110 CX		110	12,5
LHJ 120 DX	LHK 120 SX	LHL 120 CX		120	12,5
LHJ 130 DX	LHK 130 SX	LHL 130 CX		130	12,5
LHJ 140 DX	LHK 140 SX	LHL 140 CX		140	12,5
LHJ 150 DX	LHK 150 SX	LHL 150 CX		150	12,5
LHJ 160 DX	LHK 160 SX	LHL 160 CX		160	12,5
LHJ 170 DX	LHK 170 SX	LHL 170 CX		170	12,5
LHJ 180 DX	LHK 180 SX	LHL 180 CX		180	12,5
LHJ 190 DX	LHK 190 SX	LHL 190 CX		190	12,5
LHJ 200 DX	LHK 200 SX	LHL 200 CX		200	12,5
LHJ 220 DX	LHK 220 SX	LHL 220 CX		220	12,5
LHJ 240 DX	LHK 240 SX	LHL 240 CX		240	12,5
LHJ 260 DX	LHK 260 SX	LHL 260 CX		260	12,5
LHJ 280 DX	LHK 280 SX	LHL 280 CX		280	12,5
LHJ 300 DX	LHK 300 SX	LHL 300 CX		300	12,5



L min - max

80 - 300

Maggiorazione sulla misura superiore / Surcharge on larger size / Aufschlag für größeres Maß / Majoration sur la dimension supérieure / Aumento en la medida superior

Accessori compresi / Included accessories

Piletta / Waste Inclusa / Included	Copri piletta in finitura / Drain cover in finish Cristalplant	Troppo pieno / Overflow No
---------------------------------------	---	-------------------------------

Accessori suggeriti / suggested accessories

Sifone / Trap 673



Top compatibile con collezioni / Top compatible with collections:

PURE ELEMENTS - VIAVENETO ELEMENTS - VIAVENETO|G ELEMENTS

D7G

Staffa supporto top / Top brackets / Stützbügel für Top / Patte de support / Soporte encimera
fino a cm 90 = n° 2 - da cm 91 a 180 = n° 3 - da cm 181 a 250 = n° 4 - da cm 251 a 300 = n° 5

NOTE

01 08

PIANI INTEGRATI IN CRISTALPLANT BIOBASED | CRISTALPLANT BIOBASED BUILT-IN BASINS

| WASCHTISCHE MIT INTEGRIERTEM WASCHBECKEN AUS CRISTALPLANT BIOBASED | PLANS VASQUE INTÉGRÉE EN CRISTALPLANT BIOBASED | ENCIMERAS INTEGRADAS DE CRISTALPLANT BIOBASED

H 12,5

ARC

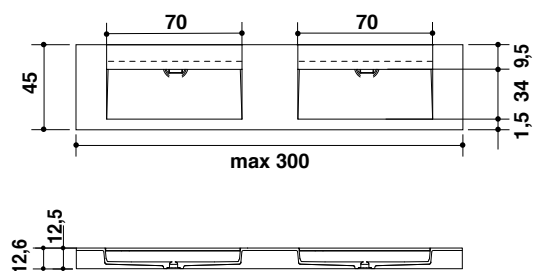
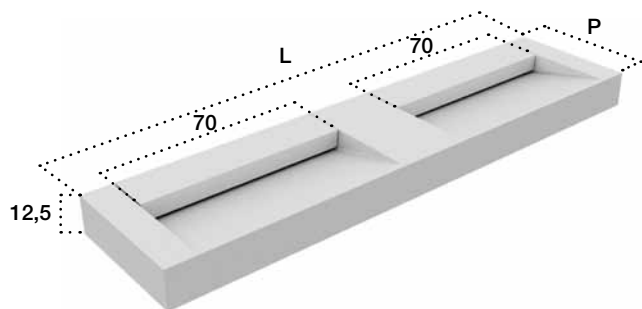

Art.	P	L	H
LHM 160	45	160	12,5
LHM 180		180	12,5
LHM 190		190	12,5
LHM 200		200	12,5
LHM 220		220	12,5
LHM 240		240	12,5
LHM 260		260	12,5
LHM 280		280	12,5
LHM 300		300	12,5



L min - max

160 - 300

Maggiorazione sulla misura superiore / Surcharge on larger size / Aufschlag für größeres Maß / Majoration sur la dimension supérieure / Aumento en la medida superior

Accessori compresi / Included accessories

Accessori suggeriti / suggested accessories

Piletta / Waste Inclusa / Included	Copri piletta in finitura / Drain cover in finish Cristalplant	Troppo pieno / Overflow No
---------------------------------------	---	-------------------------------

Sifone / Trap 673



Top compatibile con collezioni / Top compatible with collections:

PURE ELEMENTS - VIAVENETO ELEMENTS - VIAVENETO|G ELEMENTS

D7G

Staffa supporto top / Top brackets / Stützbügel für Top / Patte de support / Soporte encimera
fino a cm 90 = n° 2 - da cm 91 a 180 = n° 3 - da cm 181 a 250 = n° 4 - da cm 251 a 300 = n° 5

****Centro lavabo posizionabile su richiesta salvo distanza minima laterale di 6,5 cm / The washbasin center can be positioned on request except for a minimum lateral distance of 6.5 cm / Position der Waschbeckenmitte auf Anfrage, mit seitlichen Mindestabstand von 6,5 cm / Le centre du lavabo peut être positionné à la demande, ad exception d'une distance minimum latérale de 6,5 cm / El centro del lavabo puede ser situado a la solicitud, con una distancia lateral mínima de 6,5 cm.**

NOTE

01 08

PIANI INTEGRATI IN CRISTALPLANT BIOBASED | CRISTALPLANT BIOBASED BUILT-IN BASINS

| WASCHTISCHE MIT INTEGRIERTEM WASCHBECKEN AUS CRISTALPLANT BIOBASED | PLANS VASQUE INTÉGRÉE EN CRISTALPLANT BIOBASED | ENCIMERAS INTEGRADAS DE CRISTALPLANT BIOBASED

H 12

PURE

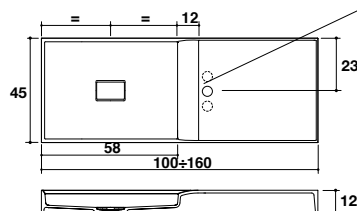
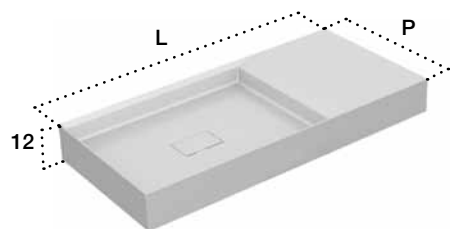

Foro rubinetto a richiesta
Hole drilling on request

Compreso
Free of charge

VERSIONE SX / LEFT VERSION

Art. DX / RIGHT

Art. SX / LEFT

P L H

D8K 100 DX

D8K 100 SX

45 100 12

D8K 120 DX

D8K 120 SX

45 120 12

D8K 140 DX

D8K 140 SX

45 140 12

D8K 160 DX

D8K 160 SX

45 160 12

Accessori compresi / Included accessories

Accessori suggeriti / suggested accessories

Piletta / Waste Art. 54J	Copri piletta in finitura / Drain cover in finish Cristalplant	Troppo pieno / Overflow No
-----------------------------	---	-------------------------------

Sifone / Trap 673

Lavabo reversibile posizionabile anche a parete con fissaggio diretto e staffa porta salviette D75/D76 / Reversible basin that can also be positioned on the wall with direct and towel bar bracket fastening D75/D76 / Das umkehrbares Waschbecken kann auch mit Direktbefestigung und Handtuchhalterbügel D75/D76 an der Wand angebracht werden / Lavabo réversible pouvant être positionné aussi au mur avec fixation directe et étrier porte-serviette D75/D76 / Lavabo reversibile que se puede posicionar también en la pared con fijación directa y abrazadera porta toallas D75/D76

STAFFA PORTA SALVIETTE PER FISSAGGIO LAVABO D8K A PARETE / FIXATION BRACKET WITH TOWEL BAR FOR WALL-MOUNTED BASIN D8K

FIXIERUNGSBÜGEL MIT HANDTUCHHALTER FÜR WANDWASCHBECKEN D8K / SUPPORT DE FIXATION AVEC PORTE-SERVIETTE POUR LAVABO D8K MURALE / SOPORTE CON PORTA PAÑUELOS PARA LAVABO D8K DE PARED



Art.

P H

D75 DX

45 5

D76 SX

45 5

VERSIONE SX / LEFT VERSION

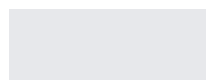

BN Bianco
White
Weiss
Blanc
Blanco mate



CC Cromo
Chrome
Chrom
Chrome
Cromo



**Top compatibile con collezioni / Top compatible with collections:
PURE ELEMENTS - VIAVENETO ELEMENTS - VIAVENETOJG ELEMENTS**

NOTE **01**

PIANI INTEGRATI IN CRISTALPLANT BIOBASED | CRISTALPLANT BIOBASED BUILT-IN BASINS

| WASCHTISCHE MIT INTEGRIERTEM WASCHBECKEN AUS CRISTALPLANT BIOBASED | PLANS VASQUE INTÉGRÉE EN CRISTALPLANT BIOBASED | ENCIMERAS INTEGRADAS DE CRISTALPLANT BIOBASED

H 10

SHAPE

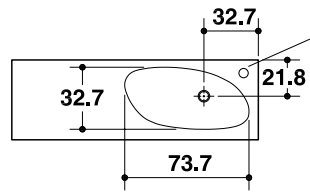
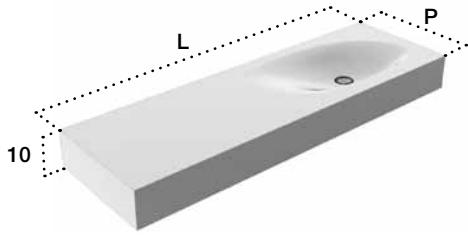

Foro rubinetto a richiesta
Hole drilling on request

Compreso
Free of charge

Art. DX / RIGHT

Art. SX / LEFT

P L H

DMC DX

DMD SX

48 93 10

DTP DX

DTQ SX

48 123 10

DTM DX

DTN SX

48 153 10

DTH DX

DTL SX

48 183 10

SHAPE

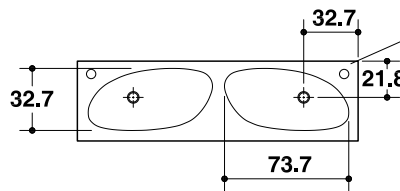
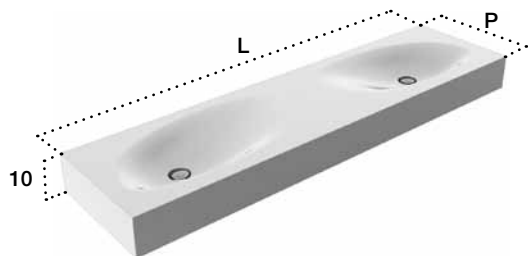

Foro rubinetto a richiesta
Hole drilling on request

Compreso
Free of charge

Art.

P L H

DME

48 183 10

Accessori compresi / Included accessories

Accessori suggeriti / suggested accessories

Piletta / Waste Art. 54E	Copri piletta in finitura / Drain cover in finish Cristalplant	Troppo pieno / Overflow Sì / Yes
-----------------------------	---	-------------------------------------

Sifone / Trap 673



Top compatibile con collezioni / Top compatible with collections:
SHAPE - SHAPE EVO

D7G Staffa supporto top / Top brackets / Stützbügel für Top / Patte de support / Soporte encimera
fino a cm 90 = n° 2 - da cm 93 a 183 = n° 3

NOTE **01**