

# ECCENTRICO

Design Victor Vasilev



## BASI COMPONENTI | MODULAR BASES

## | KOMBINIERBARE BASIS | BASES À COMPOSER | BASES MODULABLES

### H. 36 - PROFONDITÀ / DEPTH / TIEFE / PROFONDEUR / PROFUNDIDAD 45

---

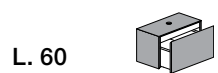

pag. 425-426  
pag. 427-428  
pag. 429-430

---

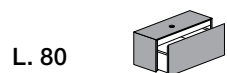

pag. 425-426  
pag. 427-428  
pag. 429-430

---

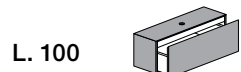

pag. 425-426  
pag. 427-428  
pag. 429-430

---

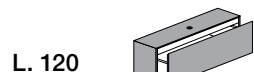

pag. 425-426  
pag. 427-428  
pag. 429-430

---

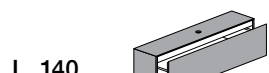

pag. 425-426  
pag. 427-428  
pag. 429-430

---

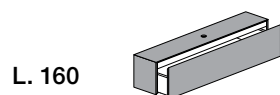

pag. 425-426  
pag. 427-428  
pag. 429-430

---











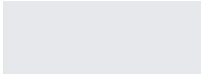





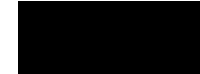





# ECCENTRICO

Design Victor Vasilev

## Finiture / Finishes / Oberfläche / Finitions / Acabados

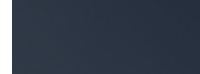
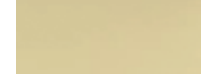
### Cat. 1

LACCATI OPACHI *Matt painted / Matt lackiert / Lacqué opaque / Laqueados opacos*

						
<b>B0 Bianco</b> White Weiß Blanc Blanco	<b>GP Grigio Pavillon</b> Pavillon grey Pavillon Grau Gris Pavillon Gris Pavillon	<b>PI Pioggia</b> Rain Regen Pluie Lluvia	<b>GL Grigio Londra</b> London grey London Grau Gris Londres Gris Londres	<b>EY Grigio Exclusive</b> Exclusive grey Exclusive Grau Gris Exclusive Gris Exclusive	<b>GF Grafite</b> Graphite Graphit Graphite Grafito	<b>N2 Nero</b> Black Schwarz Noir Negro
						
<b>CA Canapa</b> Hemp Hanf Chanvre Cáñamo	<b>S2 Sabbia</b> Sand Sand Sable Arena	<b>C2 Creta</b> Clay Ton Crête Creta	<b>C7 Castoro Ottawa</b> Ottawa beaver Biber-Farbe Ottawa Castor Ottawa Castor Ottawa	<b>CD Argilla</b> Argilla Argilla Argilla Argilla	<b>FE Ferro</b> Iron Eisen Fer Hierro	<b>V1 Verde Comodoro</b> Green Commodore Commodore Grün Vert Commodore Verde Comodoro
						
<b>FA Fango</b> Mud Schlamm Boue Barro	<b>VI Visone</b> Mink Nerz Vison Vison	<b>AZ Azzurro polvere</b> Blue powder Blau Puder Bleu poudre Azul pálido	<b>AV Avio</b> Aviation Luftfahrt Aviation Aviación	<b>B7 Blu Fes</b> Fes blue Blau Fes Bleu Fes Azul Fes	<b>C5 Cedro</b> Cedar Zeder Cédre Cedro	<b>I7 Cipria</b> Powder Puder Poudre Polvo
						
<b>V7 Verde Agave</b> Agave Green Agave Grau Vert agave Verde Agave	<b>G5 Grigio Bromo</b> Bromo grey Bromo Grau Gris Bromo Gris Bromo					

### Cat. 2

LEGNI Woods / Holz / Bois / Maderas

						
<b>R4 Rovere</b> Oak Eiche Rouvre Roble	<b>RP Rovere sbiancato</b> Bleached oak Gebleichte Eiche Rouvre blanchi Roble blanqueado	<b>RK Rovere Solid Skin</b> Solid Skin oak Eiche "Solid Skin" Rouvre "Solid Skin" Roble "Solid Skin"	<b>CG Canaletto grigio</b> Grey Canaletto Canaletto grau Canaletto gris Canaletto gris	<b>N8 Noce naturale</b> Natural walnut Nussbaum Natur Noyer naturel Nogal naturales	<b>NC Noce Canaletto</b> Canaletto walnut Nussbaum Canaletto Noyer Canaletto Nogal Canaletto	<b>N6 Noce bruciato</b> Walnut burned Nussbaum gebrannt Noyer brûlé Nogal quemado
						
<b>NW Noce Brown</b> Walnut Brown Nussbaum braun Noyer Foncé Nogal marrón	<b>RG Rovere grigio</b> Grey oak Eiche grau Rouvre gris Roble gris	<b>W4 Wengé</b> Wengé Wengé Wengé Wengué				

Tutte le finiture in legno cat. 2 possono essere richieste con venatura continua (in "biglia") / All the cat. 2 wooden finishes can have a continuous wood grain pattern on request / Auf Anfrage können alle Holzfarbe der Cat. 2 ein kontinuierliche Holzmaserung aufweisen / Toutes les finitions bois cat. 2 peuvent avoir les veines continues sous demande / Todos los acabados de madera cat 2 pueden tener un patrón de grano de madera continuo a petición

Art.

Prezzo  
Price

DSF

Optional frontal in "Biglia" / Optional front with a continuous wood grain pattern / Option Fronten mit einer kontinuierlichen Holzmaserung / Option façade avec veines continues / Opción Frontes cajones con patrón de grano de madera continuo

+ 15 %





# ECCENTRICO

Design Victor Vasilev

## Finiture / Finishes / Oberfläche / Finitions / Acabados

### Cat. 3

LACCATI LUCIDI *Glossy painted / Glanzlack / Lacqué brillant / Laqueados brillantes*

						
<b>BL Bianco</b> White Weiß Blanc Blanco	<b>GV Grigio Pavillon</b> Pavillon grey Pavillon Grau Gris Pavillon Gris Pavillon	<b>PA Pioggia</b> Rain Regen Pluie Lluvia	<b>GM Grigio Londra</b> London grey London Grau Gris Londres Gris Londres	<b>EZ Grigio Exclusive</b> Exclusive grey Exclusive Grau Gris Exclusive Gris Exclusive	<b>GT Grafite</b> Graphite Graphit Graphite Grafito	<b>N1 Nero</b> Black Schwarz Noir Negro
						
<b>CP Canapa</b> Hemp Hanf Chanvre Cáñamo	<b>S1 Sabbia</b> Sand Sand Sable Arena	<b>C1 Creta</b> Clay Ton Crête Creta	<b>C8 Castoro Ottawa</b> Ottawa beaver Biber-Farbe Ottawa Castor Ottawa Castor Ottawa	<b>CL Argilla</b> Argilla Argilla Argilla Argilla	<b>FR Ferro</b> Iron Eisen Fer Hierro	<b>V2 Verde Comodoro</b> Green Comodore Commodore Grün Vert Comodore Verde Comodoro
						
<b>FN Fango</b> Mud Schlamm Boue Barro	<b>VN Visone</b> Mink Nerz Vison Vison	<b>A1 Azzurro polvere</b> Blue powder Blau Puder Bleu poudre Azul pálido	<b>AI Avio</b> Aviation Luftfahrt Aviation Aviación	<b>B8 Blu Fes</b> Fes blue Blau Fes Bleu Fes Azul Fes	<b>Cedro</b>	<b>I8 Cipria</b> Powder Puder Poudre Polvo
						
<b>V8 Verde Agave</b> Agave Green Agave Grau Vert agave Verde Agave	<b>G6 Grigio Bromo</b> Bromo grey Bromo Grau Gris Bromo Gris Bromo					



**COLORI CAMPIONE** - Per i colori laccati a campione aggiungere 426 punti a composizione. / *Sample colours* - For sample colours add 426 points for each composition. / *Farbmuster* - Für Lackierungen nach Farbmuster 426 Punkten pro Komposition zurechnen. / *Coloris sue échantillon* - Pour les coloris laqués sur échantillon, supplément de 426 points par composition. / *Colores por muestrarios* - Para los colores laqueados según muestrario añadir 426 puntos por composición.

## CRISTALPLANT BIOBASED



**00 Bianco opaco**  
Matt white  
Weiss matt  
Blanc mat  
Blanco mate

## MARMI 1

*Marbles 1 / Marmor 1 / Marbre 1 / Marmor 1*



**MC Carrara**  
Carrara  
Carrara  
Carrara  
Carrara



**MI Piedra gris**  
Piedra gris  
Piedra gris  
Piedra gris  
Piedra gris



**MQ Nero Marquina**  
Nero Marquina  
Nero Marquina  
Nero Marquina  
Nero Marquina

## MARMI 2

*Marbles 2 / Marmor 2 / Marbre 2 / Marmor 2*



**MR Statuario**  
Statuary  
Statuarisch  
Statuaire  
Estatuario



**MP Calacatta Gold**  
Calacatta Gold  
Calacatta Gold  
Calacatta Gold  
Calacatta Gold

# MANIGLIE | HANDLES

| GRIFFE | POIGNÉES | TIRADOR

**MANIGLIA METALLO / METAL HANDLE** / METALLGRIFF / POIGNÉE EN METAL / TIRADOR DE METAL

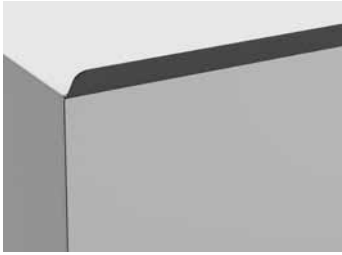

Art.  
**D9Y**

**FINITURA MANIGLIA / HANDLE FINISH** / FARBE DES GRIFFES / FINITIONS DE POIGNÉE / ACABADO TIRADOR

**METALLI**  
**METALS**



**TI**  
**Inox Titanium**  
*Stainless steel titanium*



**RM**  
**Rame spazzolato**  
*Brushed copper*



**OR**  
**Ottone spazzolato**  
*Brushed brass*



**ON**  
**Onice**  
*Onyx*

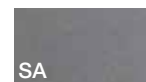

**SA**  
**Inox satinato**  
*Satin stainless steel*

## OPTIONALS | *OPTIONALS*

| ZUBEHÖRE | *OPTIONS* | OPCIONES

### CASSETTO IN LEGNO CON DIVISORI / *WOODEN DRAWER WITH DIVIDERS* / SCHUBLADE AUS HOLZ MIT TEILERN / *TIROIR EN BOIS AVEC SÉPARATEURS* / CAJÓN DE MADERA CON SEPARADORES



Art.	P	L
<b>DQW</b>	45	30-160

**Ordinare il numero di cassetti legno corrispondenti al numero di cassetti presenti nel mobile. Nello stesso mobile non è possibile ordinare due tipi di cassetti (di serie e legno).** / *Order the number of wooden drawers that corresponds to the number of drawers in the furniture. Two types of drawers in the same furniture cannot be ordered (standard or wood).* / Bestellen Sie die Anzahl der Holzschubladen entsprechend der Anzahl der Schubladen im Möbelstück. Es ist nicht möglich, zwei verschiedene Schubladentypen (Standard und Holz) für das gleiche Möbel zu bestellen. / *Commander le nombre de tiroirs en bois correspondant au nombre de tiroirs présents dans le meuble. Les tiroirs d'un même meuble ne peuvent pas être de deux types (de série et bois).* / Colocar respectivamente el número establecido en los cajones de madera con el número de los cajones situados en el mueble. En el mismo mueble no se podrán colocar dos tipos de cajones distintos.(cajonera y de madera).

**Realizzabili in tutte le finiture Falper legno e laccato opaco. Specificare sempre all'atto dell'ordine.** / *Drawers realizable in all Falper wood and matt lacquered finishes. This must always be specified at the time of the order.* / Bei allen Falper Holz- oder Mattlack-Finishs möglich. Bitte stets bei der Bestellung angeben./ *Les tiroirs sont réalisables dans toutes les finitions de bois et lacques opaque (gamme de couleurs Falper). Toujours spécifier au moment de la commande.* / Los cajones se pueden conseguir en todos los acabados de madera y laqueado mate. Especificar siempre en el momento que realiza el pedido.

**La finitura dei cassetti non influisce sulla "categoria" del mobile** / *The finish of the drawers does not affect the "colour Category" of the cabinet* / Das Finish der Schubladen hat keinen Einfluss auf die „Kategorie“ des Möbelstücks / *La finition des tiroirs n'affecte pas la "couleur" du meuble* / El acabado de los cajones no afecta a la "clase de color" de los muebles

### OPTIONAL PRESA ELETTRICA + PRESA USB / *OPTIONAL ELECTRICAL OUTLET + USB SOCKET* / OPTIONAL STROMSTECKDOSE + USB-ANSCHLUSS / *OPTION PRISE ÉLECTRIQUE + PRISE USB* / OPCIONAL ENCHUFE ELÉCTRICO + TOMA USB



Art.

**Q53 DX • Q54 SX**

**Q56 DX • Q57 SX** *Optional presa elettrica svizzera + presa USB/CH outlet / Optional CH outlet + USB socket / Optional CH Stromsteckdose + USB Anschluss / Option prise électrique CH + Prise USB / Opcional enchufe eléctrico CH + toma USB*

**Posizionabile su cassetti inferiori (max L. 90) a destra o sinistra**  
*Can be positioned on lower drawers (max L. 90) on the right or left*  
Positionierbar an den unteren Schubladen (L. max. 90) rechts oder links  
*Peut être placé sur dans les des tiroirs inférieurs (max L. 90) à droite ou à gauche*  
Puede colocarse en cajones inferiores (L. max. 90) a la derecha o a la izquierda

# BASI PER LAVABI DA APPOGGIO | BASES FOR COUNTERTOP WASHBASINS H 36

| BASIS FÜR AUFSATZWASCHBECKEN | BASES POUR VASQUE A POSER | BASES PARA LAVABOS DE APOYO

**BASE COMPLETA 1 CASSETTO / COMPLETE UNIT WITH 1 DRAWER** / KOMPLETTER UNTERSCHRANK MIT 1 SCHUBLADE  
/ MODULE COMPLET AVEC 1 TIROIR / MÓDULO CON 1 CAJÓN

**CRISTALPLANT/  
WOODEN TOP**

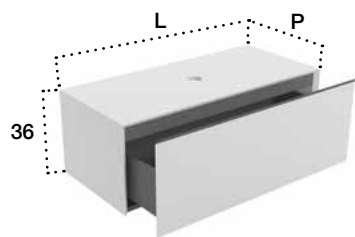

Art.	P	L
AU1 60	45	60
AU1 80		80
AU1 100		100
AU1 120		120
AU1 140		140
AU1 160		160

**Top bisellato a scelta compreso nel prezzo / Bevelled top on choice included in the price in** / Top mit 45° Kanten auf Wunsch im Preis inbegriffen aus / *Plan biseauté aux choix inclus dans le prix en* / Encimera biselada à elección incluida en el precio

- **Crystalplant (bianco opaco) / Crystalplant (matt white)** / Cristalplant (matt weiß) / *Crystalplant (blanc matte)* / Cristalplant (blanco mate)
- **Legno (colori cat 1-2-3) / Wood (colours cat 1-2-3)** / Holz (Farben Cat 1-2-3) / *bois (couleurs cat 1-2-3)* / Madera (acabados cat. 1-2-3)

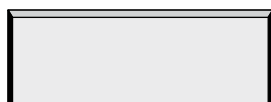

**La larghezza del top sarà pari alla larghezza totale delle composizioni. / Top width will be equal to the total width of the compositions.** / Die Breite des Tops entspricht der Gesamtbreite der Kompositionen. / *La largeur du plan sera égale à la largeur totale des compositions.* / El ancho de la encimera será igual al ancho total de las composiciones.

**BASE COMPONENTIBILE LATERALE SX, 1 CASSETTO / LEFT HAND MODULAR UNIT WITH 1 DRAWER** /  
MODULARE BASIS LINKE VERSION, 1 SCHUBLADE / *BASE MODULAIRE GAUCHE AVEC 1 TIROIR* / MÓDULO COMPONENTIBILE IZQUIERDO CON 1 CAJÓN

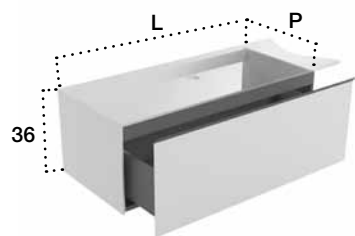

Art.	P	L
AU2 60	45	60
AU2 80		80
AU2 100		100
AU2 120		120
AU2 140		140
AU2 160		160

**Top bisellato a scelta compreso nel prezzo / Bevelled top on choice included in the price in** / Top mit 45° Kanten auf Wunsch im Preis inbegriffen aus / *Plan biseauté aux choix inclus dans le prix en* / Encimera biselada à elección incluida en el precio

- **Crystalplant (bianco opaco) / Crystalplant (matt white)** / Cristalplant (matt weiß) / *Crystalplant (blanc matte)* / Cristalplant (blanco mate)
- **Legno (colori cat 1-2-3) / Wood (colours cat 1-2-3)** / Holz (Farben Cat 1-2-3) / *bois (couleurs cat 1-2-3)* / Madera (acabados cat. 1-2-3)



**La larghezza del top sarà pari alla larghezza totale delle composizioni. / Top width will be equal to the total width of the compositions.** / Die Breite des Tops entspricht der Gesamtbreite der Kompositionen. / *La largeur du plan sera égale à la largeur totale des compositions.* / El ancho de la encimera será igual al ancho total de las composiciones.



**DQW** **Optional cassetto legno (pag. 423) / Optional wooden drawer (page 423)** / Optional Holzschublade (S.423) / *Tiroir en bois en option (page 423) / Opcional cajón de madera (pág. 423)*

# BASI PER LAVABI DA APPOGGIO | BASES FOR COUNTERTOP WASHBASINS H 36

| BASIS FÜR AUFSATZWASCHBECKEN | BASES POUR VASQUE A POSER | BASES PARA LAVABOS DE APOYO

**BASE COMPONENTIBILE LATERALE DX, 1 CASSETTO / RIGHT HAND MODULAR UNIT WITH 1 DRAWER / MODULARE BASIS RECHTE VERSION, 1 SCHUBLADE / BASE MODULAIRE DROITE AVEC 1 TIROIR / MODULO COMPONENTIBILE DERECHO CON 1 CAJÓN Y ENCIMERA EN CRISTALPLANT Y MADERA**

**CRISTALPLANT/  
WOODEN TOP**

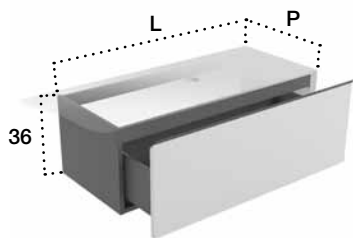

Art.	P	L
AU4 60	45	60
AU4 80		80
AU4 100		100
AU4 120		120
AU4 140		140
AU4 160		160

**Top bisellato a scelta compreso nel prezzo / Bevelled top on choice included in the price in / Top mit 45° Kanten auf Wunsch im Preis inbegriffen aus / Plan biseauté aux choix inclus dans le prix en / Encimera biselada à elección incluida en el precio**

- **Crstalplant (bianco opaco) / Crstalplant (matt white) / Crstalplant (matt weiß) / Crstalplant (blanc matte) / Crstalplant (blanco mate)**
- **Legno (colori cat 1-2-3) / Wood (colours cat 1-2-3) / Holz (Farben Cat 1-2-3) / bois (couleurs cat 1-2-3) / Madera (acabados cat. 1-2-3)**

**La larghezza del top sarà pari alla larghezza totale delle composizioni. / Top width will be equal to the total width of the compositions. / Die Breite des Tops entspricht der Gesamtbreite der Kompositionen. / La largeur du plan sera égale à la largeur totale des compositions. / El ancho de la encimera será igual al ancho total de las composiciones.**



## FINITURA MANIGLIA / HANDLE FINISH / FARBE DES GRIFFES / FINITIONS DE POIGNÉE / ACABADO TIRADOR

**METALLI  
METALS**



**TI**  
Inox Titanium  
Stainless steel titanium



**RM**  
Rame spazzolato  
Brushed copper



**OR**  
Ottone spazzolato  
Brushed brass



**ON**  
Onice  
Onyx



**SA**  
Inox satinato  
Satin stainless steel

## FINITURE TOP / TOP FINISHES / FARBEN DER TOPPLATTE / FINITIONS DU PLAN / ACABADO ENCIMERA

**LACCATI OPACHI  
MATT PAINTED**



**Realizzabile in tutte le finiture laccato opaco della Cat. 1.**  
Feasible in all the Cat. 1 matt painted finishes.

**LEGNI  
WOODS**



**Realizzabile in tutte le finiture legno della Cat. 2.**  
Feasible in all the Cat. 2 wood finishes.

**LACCATI LUCIDI  
GLOSSY PAINTED**



**Realizzabile in tutte le finiture laccato lucido della Cat. 3.**  
Feasible in all the Cat. 3 glossy painted finishes.

**CRISTALPLANT  
BIOBASED**

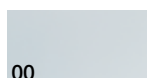

**00**  
Bianco opaco  
Matt white

## FINITURA MOBILE / FURNITURE FINISH / MÖBELFARBE / COLEUR MEUBLE / ACABADO MUEBLE

**LACCATI OPACHI  
MATT PAINTED**



**Realizzabile in tutte le finiture laccato opaco della Cat. 1.**  
Feasible in all the Cat. 1 matt painted finishes.

**LEGNI  
WOODS**



**Realizzabile in tutte le finiture legno della Cat. 2.**  
Feasible in all the Cat. 2 wood finishes.

**LACCATI LUCIDI  
GLOSSY PAINTED**



**Realizzabile in tutte le finiture laccato lucido della Cat. 3.**  
Feasible in all the Cat. 3 glossy painted finishes.



**DQW** **Optional cassetto legno (pag. 423) / Optional wooden drawer (page 423) / Optional Holzschublade (S.423) / Tiroir en bois en option (page 423) / Opcional cajón de madera (pág. 423)**



# BASI PER LAVABI DA APPOGGIO | BASES FOR COUNTERTOP WASHBASINS

# H 36

| BASIS FÜR AUFSATZWASCHBECKEN | BASES POUR VASQUE A POSER | BASES PARA LAVABOS DE APOYO

**BASE COMPLETA 1 CASSETTO / COMPLETE UNIT WITH 1 DRAWER** / KOMPLETTER UNTERSCHRANK MIT 1 SCHUBLADE / MODULE COMPLET AVEC 1 TIROIR / MÓDULO CON 1 CAJÓN

**MARBLE 1 TOP**

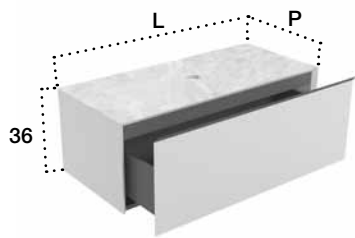

Art.	P	L
AV1 60	45	60
AV1 80		80
AV1 100		100
AV1 120		120
AV1 140		140
AV1 160		160

Top bisellato a scelta compreso nel prezzo / *Bevelled top on choice included in the price in* / Top mit 45° Kanten auf Wunsch im Preis inbegriffen aus / *Plan biseauté aux choix inclus dans le prix en* / Encimera biselada a elección incluida en el precio

• Marmo 1 / Marbles 1 / Marmor 1 / Marble 1 / Marmor 1

La larghezza del top sarà pari alla larghezza totale delle composizioni. / *Top width will be equal to the total width of the compositions.* / Die Breite des Tops entspricht der Gesamtbreite der Kompositionen. / *La largeur du plan sera égale à la largeur totale des compositions.* / El ancho de la encimera será igual al ancho total de las composiciones.

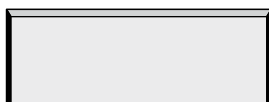

**BASE COMPONENTIBILE LATERALE SX, 1 CASSETTO / LEFT HAND MODULAR UNIT WITH 1 DRAWER** / MODULARE BASIS LINKE VERSION, 1 SCHUBLADE / BASE MODULAIRE GAUCHE AVEC 1 TIROIR / MÓDULO COMPONENTIBILE IZQUIERDO CON 1 CAJÓN

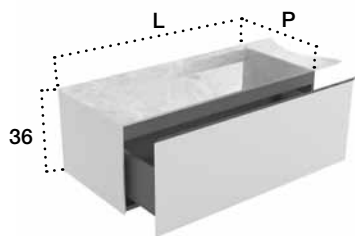

Art.	P	L
AV2 60	45	60
AV2 80		80
AV2 100		100
AV2 120		120
AV2 140		140
AV2 160		160

Top bisellato a scelta compreso nel prezzo / *Bevelled top on choice included in the price in* / Top mit 45° Kanten auf Wunsch im Preis inbegriffen aus / *Plan biseauté aux choix inclus dans le prix en* / Encimera biselada a elección incluida en el precio

• Marmo 1 / Marbles 1 / Marmor 1 / Marble 1 / Marmor 1

La larghezza del top sarà pari alla larghezza totale delle composizioni. / *Top width will be equal to the total width of the compositions.* / Die Breite des Tops entspricht der Gesamtbreite der Kompositionen. / *La largeur du plan sera égale à la largeur totale des compositions.* / El ancho de la encimera será igual al ancho total de las composiciones.

Per larghezze totali del top superiori a 2,2 m, considerare una maggiorazione prezzo del 30% sulla misura superiore / *For tops with total widths above 2,2 m, add 30% surcharge on the larger size* / Für Topplatten mit Gesamtbreiten über 2,2 m, 30% Aufpreis auf der breitesten Maße / *Pour de plans ayant une largeur totale supérieure à 2,2 m, ajouter 30% au prix de la largeur supérieure* / Por ancho total de la encimera sobre 2,2 m añadir 30% sobre el precio de la medida superior



**DQW** Optional cassetto legno (pag. 423) / *Optional wooden drawer (page 423)* / Optional Holzschublade (S.423) / *Tiroir en bois en option (page 423)* / Opcional cajón de madera (pág. 423)

# BASI PER LAVABI DA APPOGGIO | BASES FOR COUNTERTOP WASHBASINS

| BASIS FÜR AUFSATZWASCHBECKEN | BASES POUR VASQUE A POSER | BASES PARA LAVABOS DE APOYO

# H 36

**BASE COMPONENTIBILE LATERALE DX, 1 CASSETTO / RIGHT HAND MODULAR UNIT WITH 1 DRAWER /**  
 MODULARE BASIS RECHTE VERSION, 1 SCHUBLADE / BASE MODULAIRE DROITE AVEC 1 TIROIR / MODULO COMPONENTIBILE DERECHO CON 1 CAJÓN

**MARBLE 1  
TOP**

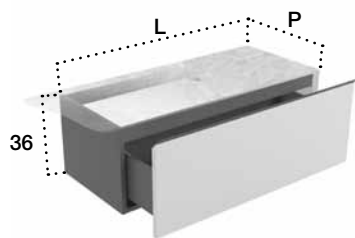

Art.	P	L
AV4 60	45	60
AV4 80		80
AV4 100		100
AV4 120		120
AV4 140		140
AV4 160		160

**Top bisellato a scelta compreso nel prezzo / Bevelled top on choice included in the price in /** Top mit 45° Kanten auf Wunsch im Preis inbegriffen aus / *Plan biseauté aux choix inclus dans le prix en / Encimera biselada à elección incluida en el precio*  
 • **Marmo 1 / Marbles 1 / Marmor 1 / Marble 1 / Marmor 1**

**La larghezza del top sarà pari alla larghezza totale delle composizioni. / Top width will be equal to the total width of the compositions. /** Die Breite des Tops entspricht der Gesamtbreite der Kompositionen. / *La largeur du plan sera égale à la largeur totale des compositions. / El ancho de la encimera será igual al ancho total de las composiciones.*

**Per larghezze totale del top superiori a 2,2 m, considerare una maggiorazione prezzo del 30% sulla misura superiore / For tops with total widths above 2,2 m, add 30% surcharge on the larger size /** Für Topplatten mit Gesamtbreiten über 2,2 m, 30% Aufpreis auf der breitesten Maße / *Pour de plans ayant une largeur totale supérieure à 2,2 m, ajouter 30% au prix de la largeur supérieure / Por ancho total de la encimera sobre 2,2 m añadir 30% sobre el precio de la medida superior*



## FINITURA MANIGLIA / HANDLE FINISH / FARBE DES GRIFFES / FIN

### METALLI METALS



**TI**  
Inox Titanium  
Stainless steel titanium



**RM**  
Rame spazzolato  
Brushed copper



**OR**  
Ottone spazzolato  
Brushed brass



**ON**  
Onice  
Onyx

## FINITURE TOP / TOP FINISHES / FARBEN DER TOPPLATTE / FINITION

### MARMI 1 MARBLES 1



**MC**  
Carrara  
Carrara



**MI**  
Pietra Grey  
Grey stone

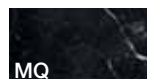

**MQ**  
Nero Marquinia  
Nero Marquinia

## FINITURA MOBILE / FURNITURE FINISH / MÖBELFARBE / COLEUR MEUBLE / ACABADO MUEBLE

### LACCATI OPACHI MATT PAINTED



Realizzabile in tutte le finiture laccato opaco della Cat. 1.  
Feasible in all the Cat. 1 matt painted finishes.

### LEGNI WOODS



Realizzabile in tutte le finiture legno della Cat. 2.  
Feasible in all the Cat. 2 wood finishes.



**DQW** Optional cassetto legno (pag. 423) / *Optional wooden drawer (page 423) / Optional Holzschublade (S.423) / Tiroir en bois en option (page 423) / Opcional cajón de madera (pág. 423)*

# BASI PER LAVABI DA APPOGGIO | BASES FOR COUNTERTOP WASHBASINS

# H 36

| BASIS FÜR AUFSATZWASCHBECKEN | BASES POUR VASQUE A POSER | BASES PARA LAVABOS DE APOYO

## BASE COMPLETA 1 CASSETTO / COMPLETE UNIT WITH 1 DRAWER / KOMPLETTER UNTERSCHRANK MIT 1 SCHUBLADE / MODULE COMPLET AVEC 1 TIROIR / MÓDULO CON 1 CAJÓN

### MARBLE 2 TOP

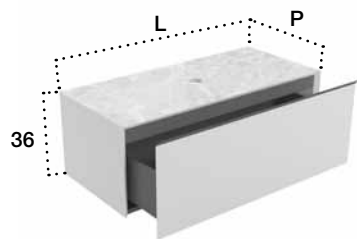

Art.	P	L
AW1 60	45	60
AW1 80		80
AW1 100		100
AW1 120		120
AW1 140		140
AW1 160		160

Top bisellato a scelta compreso nel prezzo / *Bevelled top on choice included in the price in* / Top mit 45° Kanten auf Wunsch im Preis inbegriffen aus / *Plan biseauté aux choix inclus dans le prix en* / Encimera biselada a elección incluida en el precio

- Marmo 2 / Marbles 2 / Marmor 2 / Marbre 2 / Marmor 2

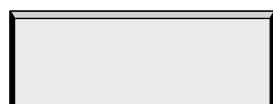

La larghezza del top sarà pari alla larghezza totale delle composizioni. / *Top width will be equal to the total width of the compositions.* / Die Breite des Tops entspricht der Gesamtbreite der Kompositionen. / *La largeur du plan sera égale à la largeur totale des compositions.* / El ancho de la encimera será igual al ancho total de las composiciones.

## BASE COMPONENTIBILE LATERALE SX, 1 CASSETTO / LEFT HAND MODULAR UNIT WITH 1 DRAWER / MODULARE BASIS LINKE VERSION, 1 SCHUBLADE / BASE MODULAIRE GAUCHE AVEC 1 TIROIR / MÓDULO COMPONENTIBILE IZQUIERDO CON 1 CAJÓN

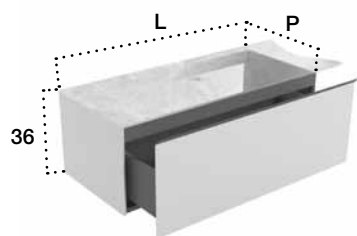

Art.	P	L
AW2 60	45	60
AW2 80		80
AW2 100		100
AW2 120		120
AW2 140		140
AW2 160		160

Top bisellato a scelta compreso nel prezzo / *Bevelled top on choice included in the price in* / Top mit 45° Kanten auf Wunsch im Preis inbegriffen aus / *Plan biseauté aux choix inclus dans le prix en* / Encimera biselada a elección incluida en el precio

- Marmo 2 / Marbles 2 / Marmor 2 / Marbre 2 / Marmor 2



La larghezza del top sarà pari alla larghezza totale delle composizioni. / *Top width will be equal to the total width of the compositions.* / Die Breite des Tops entspricht der Gesamtbreite der Kompositionen. / *La largeur du plan sera égale à la largeur totale des compositions.* / El ancho de la encimera será igual al ancho total de las composiciones.

Per larghezze totali del top superiori a 2,2 m, considerare una maggiorazione prezzo del 30% sulla misura superiore / *For tops with total widths above 2,2 m, add 30% surcharge on the larger size* / Für Topplatten mit Gesamtbreiten über 2,2 m, 30% Aufpreis auf der breitesten Maße / *Pour de plans ayant une largeur totale supérieure à 2,2 m, ajouter 30% au prix de la largeur supérieure* / Por ancho total de la encimera sobre 2,2 m añadir 30% sobre el precio de la medida superior / *Por ancho total de la encimera sobre 2,2 m añadir 30% sobre el precio de la medida superior*



DQW Optional cassetto legno (pag. 423) / *Optional wooden drawer (page 423)* / Optional Holzschublade (S.423) / *Tiroir en bois en option (page 423)* / Opcional cajón de madera (pág. 423)

# BASI PER LAVABI DA APPOGGIO | BASES FOR COUNTERTOP WASHBASINS

| BASIS FÜR AUFSATZWASCHBECKEN | BASES POUR VASQUE A POSER | BASES PARA LAVABOS DE APOYO

# H 36

**BASE COMPONENTIBILE LATERALE SX, 1 CASSETTO / LEFT HAND MODULAR UNIT WITH 1 DRAWER /**  
 MODULARE BASIS LINKE VERSION, 1 SCHUBLADE / BASE MODULAIRE GAUCHE AVEC 1 TIROIR / MODULO COMPONENTIBILE IZQUIERDO CON 1 CAJÓN

**MARBLE 2  
TOP**

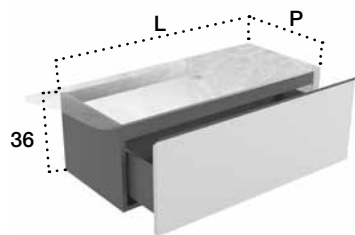

Art.	P	L
AW4 60	45	60
AW4 80		80
AW4 100		100
AW4 120		120
AW4 140		140
AW4 160		160

**Top bisellato a scelta compreso nel prezzo / Bevelled top on choice included in the price in /** Top mit 45° Kanten auf Wunsch im Preis inbegriffen aus / *Plan biseauté aux choix inclus dans le prix en / Encimera biselada à elección incluida en el precio*  
 • **Marmo 2 / Marbles 2 / Marmor 2 / Marble 2 / Marmor 2**

**La larghezza del top sarà pari alla larghezza totale delle composizioni. / Top width will be equal to the total width of the compositions. /** Die Breite des Tops entspricht der Gesamtbreite der Kompositionen. / *La largeur du plan sera égale à la largeur totale des compositions. / El ancho de la encimera será igual al ancho total de las composiciones.*

**Per larghezze totali del top superiori a 2,2 m, considerare una maggiorazione prezzo del 30% sulla misura superiore / For tops with total widths above 2,2 m, add 30% surcharge on the larger size /** Für Topplatten mit Gesamtbreiten über 2,2 m, 30% Aufpreis auf der breitesten Maße / *Pour de plans ayant une largeur totale supérieure à 2,2 m, ajouter 30% au prix de la largeur supérieure / Por ancho total de la encimera sobre 2,2 m añadir 30% sobre el precio de la medida superior*

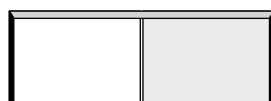

## FINITURA MANIGLIA / HANDLE FINISH / FARBE DES GRIFFES / FINITIONS DE POIGNÉE / ACABADO TIRADOR

### METALLI METALS



**TI**  
Inox Titanium  
Stainless steel titanium



**RM**  
Rame spazzolato  
Brushed copper



**OR**  
Ottone spazzolato  
Brushed brass



**ON**  
Onice  
Onyx

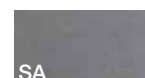

**SA**  
Inox satinato  
Satin stainless steel

## FINITURE TOP / TOP FINISHES / FARBEN DER TOPPLATTE / FINITIONS DU PLAN / ACABADO ENCIMERA

### MARMI 2 MARBLES 2



**MR**  
Statuario  
Statuary



**MP**  
Calacatta Gold  
Calacatta Gold

## FINITURA MOBILE / FURNITURE FINISH / MÖBELFARBE / COLEUR MEUBLE / ACABADO MUEBLE

### LACCATI OPACHI MATT PAINTED



Realizzabile in tutte le finiture laccato opaco della Cat. 1.  
*Feasible in all the Cat. 1 matt painted finishes.*

### LEGNI WOODS



Realizzabile in tutte le finiture legno della Cat. 2.  
*Feasible in all the Cat. 2 wood finishes.*

### LACCATI LUCIDI GLOSSY PAINTED



Realizzabile in tutte le finiture laccato lucido della Cat. 3.  
*Feasible in all the Cat. 3 glossy painted finishes.*



**DQW** Optional cassetto legno (pag. 423) / *Optional wooden drawer (page 423) / Optional Holzschublade (S.423) / Tiroir en bois en option (page 423) / Opcional cajón de madera (pág. 423)*

# LAVABI DA TERRA | FREESTANDING BASINS

| FREISTEHENDE WASCHECKEN | LAVABOS À COLONNE | LAVABO EN COLUMNA

LAVABO FREESTANDING IN CRISTALPLANT BIOBASED E LEGNO / CRISTALPLANT BIOBASED AND WOOD FREESTANDING WASHBASIN / FREISTEHENDES WASCHECKEN AUS CRISTALPLANT BIOBASED UND HOLZ / LAVABO SUR PIED EN CRISTALPLANT BIOBASED ET BOIS / LAVABO FREESTANDING EN CRISTALPLANT BIOBASED Y MADERA

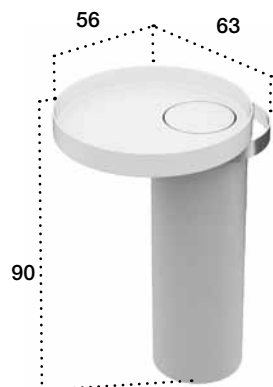

Art.	L	P	H
<b>WN5</b>	63	56	90

Accessori compresi / Included accessories

Piletta / Waste Art. 54G	Copri piletta in finitura / Drain cover in finish Cristalplant	Troppo pieno / Overflow No
-----------------------------	---	-------------------------------

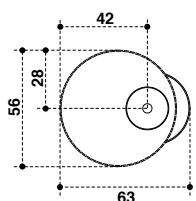
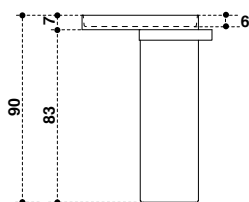

FINITURE PORTA SALVIETTE / TOWEL BAR FINISHES / OBERFLÄCHE DES HANDTUCHHALTERS / FINITION DU PORTE-SERVIETTE / ACABADOS DEL SUPORTE PORTA PAÑUELOS

METALLI  
METALS



**TI**  
Inox Titanium  
Stainless steel titanium



**RM**  
Rame spazzolato  
Brushed copper



**OR**  
Ottone spazzolato  
Brushed brass



**ON**  
Onice  
Onyx

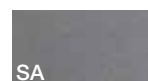

**SA**  
Inox satinato  
Satin stainless steel

FINITURE BASAMENTO / BASE FINISHES / OBERFLÄCHE DER SÄULE / FINITION DE LA BASE / ACABADOS BASE

LEGNI  
WOODS



Realizzabile in tutte le finiture legno della Cat. 2.  
**Feasible in all the Cat. 2 wood finishes.**  
Herstellbar in allen Holzfarben (Cat. 2)  
Réalisable en toutes les finition bois de la Cat. 2.  
Factible en todos los acabados madera (Cat. 2).



**AA Acacia TH**  
Acacia TH  
Akazie TH  
Acacia TH  
Acacia TH

# LAVABI DA TERRA | FREESTANDING BASINS

| FREISTEHENDE WASCHBECKEN | LAVABOS À COLONNE | LAVABO EN COLUMNA

**LAVABO FREESTANDING IN MARMO E LEGNO / MARBLE AND WOOD FREESTANDING WASHBASIN** / FREISTEHENDES WASCHBECKEN AUS MARMOR UND HOLZ / LAVABO SUR PIED EN MARBRE ET BOIS / LAVABO FREESTANDING EN MARMOL Y MADERA

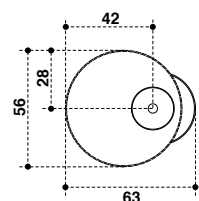
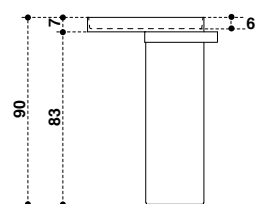
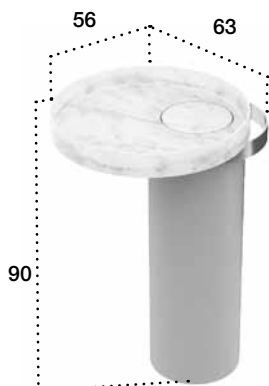

Art.	L	P	H
<b>WN7</b>	63	56	90

Accessori compresi / Included accessories

Piletta / Waste Art. 54G	Copri piletta in finitura / Drain cover in finish Marmo / Marble	Troppo pieno / Overflow No
-----------------------------	---	-------------------------------

## FINITURE LAVABO / BASIN FINISHES / OBERFLÄCHE DES WASCHBECKENS / FINITION DU LAVABO / ACABADOS DE LAVABO

MARMI 1  
MARBLES 1

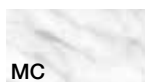

Carrara



Pietra Grey



Nero Marquina

Marmi in finitura satinata opaca.  
**Marble feasible in satin matte finish.**  
Marmor in satiniertes matter Ausführung  
Marbre en finition matte satinée.  
Mármol en un acabado mate satinado.

MARMI 2  
MARBLES 2



Statuario



Calacatta Gold

## FINITURE PORTA SALVIETTE / TOWEL BAR FINISHES / OBERFLÄCHE DES HANDTUCHHALTERS / FINITION DU PORTE-SERVIETTE / ACABADOS DEL SUPORTE PORTA PAÑUELOS

METALLI  
METALS



Inox Titanium  
Stainless steel titanium



Rame spazzolato  
Brushed copper



Ottone spazzolato  
Brushed brass



Onice  
Onyx

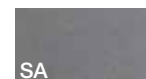

Inox satinato  
Satin stainless steel

## FINITURE BASAMENTO / BASE FINISHES / OBERFLÄCHE DER SÄULE / FINITION DE LA BASE / ACABADOS BASE

LEGNI  
WOODS



Realizzabile in tutte le finiture legno della Cat. 2.  
**Feasible in all the Cat. 2 wood finishes.**  
Herstellbar in allen Holzfarben (Cat. 2)  
Réalisable en toutes les finitions bois de la Cat. 2.  
Factible en todos los acabados madera (Cat. 2).



**AA Acacia TH**  
Acacia TH  
Akazie TH  
Acacia TH  
Acacia TH

# LAVABI DA APPOGGIO | COUNTERTOP WASHBASINS

| AUFSATZBECKEN | VASQUES À POSER | LAVABOS DE APOYO

## LAVABO DA APPOGGIO IN CRISTALPLANT / COUNTERTOP BASIN IN CRISTALPLANT / AUFSATZWASCHBECKEN AUS CRISTALPLANT / VASQUE À POSER EN CRISTAL PLANT / LAVABO DE APOYO EN CRISTALPLANT



Art.	L	P	H
<b>WN1</b>	56	56	14

Accessori compresi / Included accessories

Piletta / Waste Art. 54G	Copri piletta in finitura / Drain cover in finish Cristalplant	Troppo pieno / Overflow No
-----------------------------	---	-------------------------------

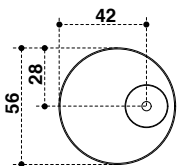
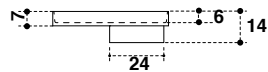

**N.B. fissaggio al top del mobile tramite viti** / Remark: fixing to the cabinet top with screws / Anmerkung: Befestigung zur Möbeltopplatte durch Schrauben / Attention : fixation au top du meuble avec des vis.. / Nota: fijación a la encimera del armario con tornillos

## LAVABO DA APPOGGIO IN MARMO / COUNTERTOP BASIN IN MARBLE / AUFSATZ WASCHBECKEN AUS MARMOR / VASQUE À POSER EN MARBRE / LAVABO DE APOYO EN MARMOL



Art.	L	P	H
<b>WN3</b>	56	56	14

Accessori compresi / Included accessories

Piletta / Waste Art. 54G	Copri piletta in finitura / Drain cover in finish Marmo / Marble	Troppo pieno / Overflow No
-----------------------------	---	-------------------------------

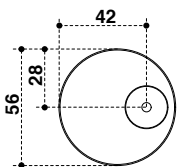
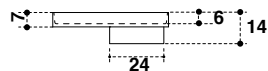

**N.B. fissaggio al top del mobile tramite viti** / Remark: fixing to the cabinet top with screws / Anmerkung: Befestigung zur Möbeltopplatte durch Schrauben / Attention : fixation au top du meuble avec des vis.. / Nota: fijación a la encimera del armario con tornillos

### MARMI 1 MARBLES 1

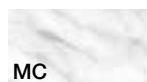

**MC**  
Carrara  
Carrara



**MI**  
Pietra Grey  
Grey Stone



**MQ**  
Nero Marquina  
Nero Marquina

**Marmi in finitura satinata opaca.**  
**Marble feasible in satin matte finish.**  
Marmor in satiniert matter Ausführung  
Marbre en finition matte satinée.  
Mármol en un acabado mate satinado.

### MARMI 2 MARBLES 2



**MR**  
Statuario  
Statuary



**MP**  
Calacatta Gold  
Calacatta Gold

**falper.**

Modello: ECCENTRICO

Articolo: WN5

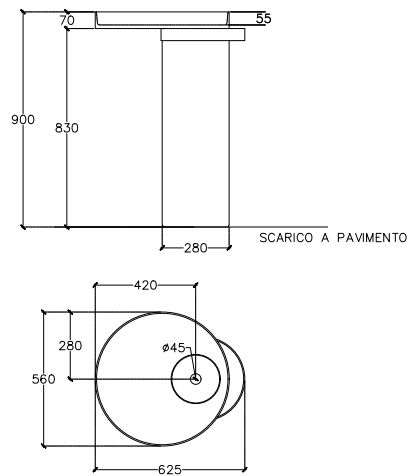

**DISEGNI TECNICI CON POSIZIONAMENTO IMPIANTI DISPONIBILI SUL SITO WEB**  
*TECHNICAL DRAWINGS WITH DIMENSIONS AVAILABLE ON OUR WEB SITE*  
**TECHNISCHE DATENBLÄTTER MIT MASSEN AUF UNSERER WEBSITE**  
*FICHES TECHNIQUES AVEC DIMENSIONS DISPONIBLES SUR NOTRE SITE WEB*  
**DIBUJOS TÉCNICOS CON MEDIDAS DISPONIBLES EN NUESTRO SITO WEB**