

SHAPE EVO

Design Michael Schmidt



SHAPE EVO

SHAPE EVO

Design Michael Schmidt



MOBILI / FURNITURE / MEUBLES / MÖBEL / MUEBLES

H. 33 - PROFONDITÀ / DEPTH / TIEFE / PROFONDEUR / PROFUNDIDAD 48

L. 93

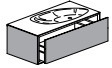

pag. 347

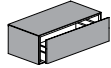

pag. 351/356

L. 123

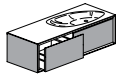

pag. 347

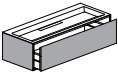

pag. 349

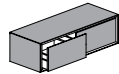

pag. 351/356

L. 153

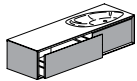

pag. 347

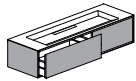

pag. 349

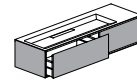

pag. 349

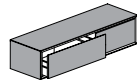

pag. 351/356

L. 183

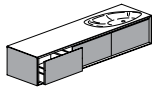

pag. 348

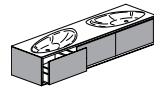

pag. 348

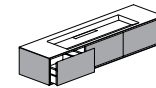

pag. 350

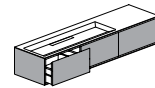

pag. 350

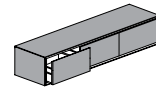

pag. 351/356

H. 50 - PROFONDITÀ / DEPTH / TIEFE / PROFONDEUR / PROFUNDIDAD 48

L. 93

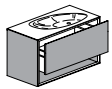

pag. 357

L. 123

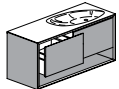

pag. 357

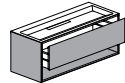

pag. 359

L. 153

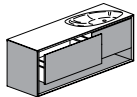

pag. 357

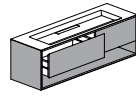

pag. 359

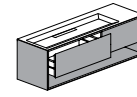

pag. 359

L. 183

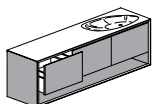

pag. 358

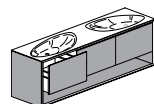

pag. 358

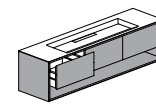

pag. 360

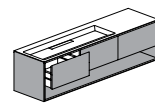

pag. 360

COLONNE / COLUMNS / HOCHSCHRÄNKE / COLONNES / COLUMNAS

H. 180 - PROFONDITÀ / DEPTH / TIEFE / PROFONDEUR / PROFUNDIDAD 23 - 38

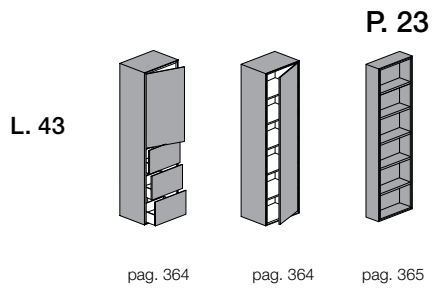
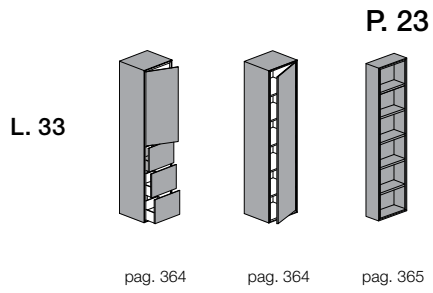











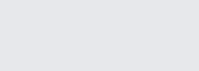
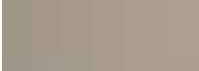

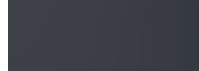
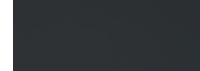
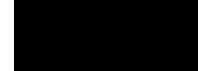





SHAPE EVO

Design Michael Schmidt

Finiture / Finishes / Oberfläche / Finitions / Acabados

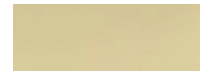
Cat. 1

LACCATI OPACHI *Matt painted / Matt lackiert / Lacqué opaque / Laqueados opacos*

						
B0 Bianco White Weiß Blanc Blanco	GP Grigio Pavillon Pavillon grey Pavillon Grau Gris Pavillon Gris Pavillon	PI Pioggia Rain Regen Pluie Lluvia	GL Grigio Londra London grey London Grau Gris Londres Gris Londres	EY Grigio Exclusive Exclusive grey Exclusive Grau Gris Exclusive Gris Exclusive	GF Grafite Graphite Graphit Graphite Grafito	N2 Nero Black Schwarz Noir Negro
						
CA Canapa Hemp Hanf Chanvre Cáñamo	S2 Sabbia Sand Sand Sable Arena	C2 Creta Clay Ton Crête Creta	C7 Castoro Ottawa Ottawa beaver Biber-Farbe Ottawa Castor Ottawa Castor Ottawa	CD Argilla Argilla Argilla Argilla Argilla	FE Ferro Iron Eisen Fer Hierro	V1 Verde Comodoro Green Commodore Commodore Grün Vert Commodore Verde Comodoro
						
FA Fango Mud Schlamm Boue Barro	VI Visone Mink Nerz Vison Vison	AZ Azzurro polvere Blue powder Blau Puder Bleu poudre Azul pálido	AV Avio Aviation Luftfahrt Aviation Aviación	B7 Blu Fes Fes blue Blau Fes Bleu Fes Azul Fes	C5 Cedro Cedar Zeder Cédre Cedro	I7 Cipria Powder Puder Poudre Polvo
						
V7 Verde Agave Agave Green Agave Grau Vert agave Verde Agave	G5 Grigio Bromo Bromo grey Bromo Grau Gris Bromo Gris Bromo					

Cat. 2

LEGNI *Woods / Holz / Bois / Maderas*

						
R4 Rovere Oak Eiche Rouvre Roble	RP Rovere sbiancato Bleached oak Gebleichte Eiche Rouvre blanchi Roble blanqueado	RK Rovere Solid Skin Solid Skin oak Eiche "Solid Skin" Rouvre "Solid Skin" Roble "Solid Skin"	CG Canaletto grigio Grey Canaletto Canaletto grau Canaletto gris Canaletto gris	N8 Noce naturale Natural walnut Nussbaum Natur Noyer naturel Nogal naturales	NC Noce Canaletto Canaletto walnut Nussbaum Canaletto Noyer Canaletto Nogal Canaletto	N6 Noce bruciato Walnut burned Nussbaum gebrannt Noyer brûlé Nogal quemado
						
NW Noce Brown Walnut Brown Nussbaum braun Noyer Foncé Nogal marrón	RG Rovere grigio Grey oak Eiche grau Rouvre gris Roble gris	W4 Wengé Wengé Wengé Wengé Wengué				



COLORI CAMPIONE - Per i colori laccati a campione aggiungere 426 punti a composizione. / Sample colours - For sample colours add 426 points for each composition. / Farbmuster - Für Lackierungen nach Farbmuster 426 Punkten pro Komposition zurechnen. / Coloris sur échantillon - Pour les coloris laqués sur échantillon, supplément de 426 points par composition. / Colores por muestrarios - Para los colores laqueados según muestrario añadir 426 puntos por composición.











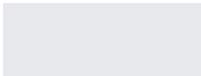





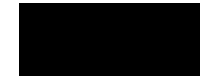





SHAPE EVO

Design Michael Schmidt

Finiture / Finishes / Oberfläche / Finitions / Acabados

Cat. 3

LACCATI LUCIDI *Glossy painted / Glanzlack / Lacqué brillant / Laqueados brillantes*

						
BL Bianco <i>White Weiß Blanc Blanco</i>	GV Grigio Pavillon <i>Pavillon grey Pavillon Grau Gris Pavillon Gris Pavillon</i>	PA Pioggia <i>Rain Regen Pluie Iluvia</i>	GM Grigio Londra <i>London grey London Grau Gris Londres Gris Londres</i>	EZ Grigio Exclusive <i>Exclusive grey Exclusive Grau Gris Exclusive Gris Exclusive</i>	GT Grafite <i>Graphite Graphit Graphite Grafito</i>	N1 Nero <i>Black Schwarz Noir Negro</i>
						
CP Canapa <i>Hemp Hanf Chanvre Cáñamo</i>	S1 Sabbia <i>Sand Sand Sable Arena</i>	C1 Creta <i>Clay Ton Crête Creta</i>	C8 Castoro Ottawa <i>Ottawa beaver Biber-Farbe Ottawa Castor Ottawa Castor Ottawa</i>	CL Argilla <i>Argilla Argilla Argilla Argilla</i>	FR Ferro <i>Iron Eisen Fer Hierro</i>	V2 Verde Comodoro <i>Green Comodoro Comodoro Grün Vert Comodoro Verde Comodoro</i>
						
FN Fango <i>Mud Schlamm Boue Barro</i>	VN Visone <i>Mink Nerz Vison Visòn</i>	A1 Azzurro polvere <i>Blue powder Blau Puder Bleu poudre Azul pálido</i>	AI Avio <i>Aviation Luftfahrt Aviation Aviación</i>	B8 Blu Fes <i>Fes blue Blau Fes Bleu Fes Azul Fes</i>	Cedro	I8 Cipria <i>Powder Puder Poudre Polvo</i>
						
V8 Verde Agave <i>Agave Green Agave Grau Vert agave Verde Agave</i>	G6 Grigio Bromo <i>Bromo grey Bromo Grau Gris Bromo Gris Bromo</i>					

Cat. 4

LEGNI MASSELLO *Solid wood / Massivholz / Bois massif / Madera maciza*



MA Massello di rovere
*Oak solid wood
Massivholz Eiche
Bois massif rouvre
Madera maciza roble*

I mobili di questa categoria sono realizzati interamente in legno massello di rovere ed assemblati senza telaio Frame per consentire il naturale adattamento climatico ed igrometrico del materiale. / *The furniture of this category are made entirely of solid oak and assembled without frame to allow the climate and hygrometric natural adaptation of the material.* / Die Möbel sind komplett aus massiver Eiche hergestellt und ohne Rahmen montiert, um die natürliche klimatische und hygrometrische Anpassung des Materials zu ermöglichen / *Les meubles sont fabriqués entièrement en chêne massif et assemblés sans châssis pour permettre la naturelle adaptation hygrométrique et climatique des matériaux* / Los muebles están hechos totalmente de madera maciza de roble y montados sin marco para permitir la natural adaptación higrométrico y climático del material.

MANIGLIE | HANDLES

| GRIFFE | POIGNÉES | TIRADOR

MANIGLIA GOLA / GROOVED HANDLE / GRIFFMULDE 45° / POIGNÉE PRISE DE MAIN / TIRADOR GOLA



Art.

Massello Rovere*
Solid oak

Bianco
White

Acciaio lucido
Polished steel

D9R

*** Maniglia realizzabile solo sui mobili in massello di rovere (Cat. 4)**

Handle can be set only on solid oak units (Cat. 4)

Griff nur für Möbel aus massiver Eiche realisierbar (Cat.4)

Poignée réalisable seulement sur meubles en massif de rouvre (Cat. 4)

Tirador realizable solamente en los muebles de madera de roble (Cat. 4)

MANIGLIA PREMI/APRI / "PRESS-AND-OPEN" HANDLE / GRIFF "DRÜCKEN-ÖFFNEN" / POIGNÉE "OUVERTURE PRESSION" / TIRADOR "APRIETA Y ABRE"



Art.

D9V

Maniglia non realizzabile su mobili in massello di rovere.

Handle cannot be set on solid oak units.

Griff nicht für Möbel aus massiver Eiche realisierbar.

Poignée non réalisable sur meubles en massif de rouvre.

Tirador no realizable en muebles de madera de roble.

OPTIONALS | *OPTIONALS*

| ZUBEHÖRE | *OPTIONS* | OPCIONES

OPTIONAL - CASSETTO UNICO SU MOBILE SHAPE EVO L. 123/153 / *SINGLE DRAWER ON SHAPE EVO WALL UNIT L. 123/153* / EINZELSCHUBLADE IM MÖBEL SHAPE EVO L. 123/153 / *TIROIR UNIQUE SUR MUEBLE SHAPE EVO L. 123/153* / CAJÓN ÚNICO EN MUEBLE SHAPE EVO L. 123/153



Art.	L	H
ZZ1	123/153	33

Optional cassetto unico disponibile per tutti i modelli Shape Evo H. 33 nelle larghezze 123 e 153 / Optional single drawer available for all Shape Evo models H. 33 in widths 123 and 153 / Die optionale Einzelschublade ist für alle Modelle Shape Evo H. 33 in den Breiten 123 und 153 verfügbar / En option, tiroir unique disponible pour tous les modèles Shape Evo H. 33 dans les largeurs 123 et 153 / Cajón único disponible como opcional para todos los modelos Shape Evo H. 33 en los anchos 123 y 153

(*) Optional non disponibile nella versione Massello di Rovere Cat. 4

Option not available for Solid Oak version Cat. 4

Das Optional ist nicht in Ausführung Massivholz Eiche Kat. 4 verfügbar

En option non disponible dans la version chêne massif cat. 4

Opcional no disponible en la versión madera maciza de roble Cat. 4

OPTIONAL PRESA ELETTRICA + PRESA USB / *OPTIONAL ELECTRICAL OUTLET + USB SOCKET* / OPT ANSCHLUSS / *OPTION PRISE ÉLECTRIQUE + PRISE USB* / OPCIONAL ENCHUFE ELÉCTRICO + TOMA USB

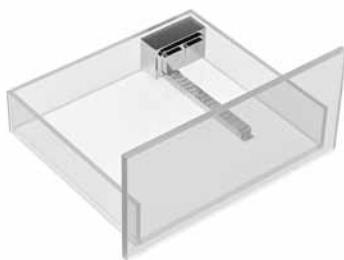

Art.

Q53 DX • Q54 SX

Q56 DX • Q57 SX Optional presa elettrica svizzera + presa USB/CH outlet / *Optional CH outlet + USB socket* / Optional CH Stromsteckdose + USB Anschluss / *Option prise électrique CH + Prise USB* / Opcional enchufe electrico CH + toma USB

Posizionabile su cassetti inferiori (max L. 90) a destra o sinistra

This option can be positioned on lower drawers (max L. 90) on the right or left

Positionierbar an den unteren Schubladen (L. max. 90) rechts oder links

Peut être placé dans les tiroirs inférieurs (max L. 90) à droite ou à gauche

Puede colocarse en cajones inferiores (L. max. 90) a la derecha o a la izquierda

OPTIONAL PRESA ELETTRICA + PRESA USB / *OPTIONAL ELECTRICAL OUTLET + USB SOCKET* / OPTIONAL STROMSTECKDOSE + USB-ANSCHLUSS / *OPTION PRISE ÉLECTRIQUE + PRISE USB* / OPCIONAL ENCHUFE ELÉCTRICO + TOMA USB



Art.

Q55

Q58

Optional presa elettrica svizzera + presa USB/CH outlet / *Optional CH outlet + USB socket* / Optional CH Stromsteckdose + USB Anschluss / *Option prise électrique CH + Prise USB* / Opcional enchufe electrico CH + toma USB

Specificare all'atto dell'ordine il posizionamento della presa sulla colonna o pensile. / *Specify socket positioning in the column or wall unit at the order* / Positionierung der Steckdose im Hochschrank oder Hängeschrank angeben / *Indiquer au moment de la commande la position des prises dans sur la colonne ou niche* / Indicar la position de la toma en la columna y en el armario de pared.

MOBILI CON LAVABO SHAPE | MODULE WITH SHAPE BASIN

| MÖBEL MIT WASCHBECKEN SHAPE | MODULE AVEC LAVABO SHAPE | MUEBLE CON LAVABO SHAPE

H 33

MOBILE 1 CASSETTO, TOP INTEGRATO SHAPE / UNIT WITH 1 DRAWER AND SHAPE BUILT-IN BASIN / MÖBEL MIT 1 SCHUBLADE UND WASCHTISCH SHAPE / MEUBLE AVEC 1 TIROIR ET PLAN VASQUE INTÉGRÉE SHAPE / MUEBLE CON 1 CAJON Y LAVABO INTEGRADO SHAPE

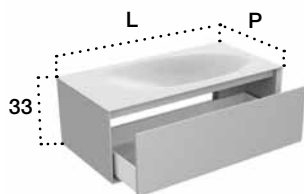

VERSIONE DX / RIGHT VERSION

Art.	L	P
ZAA DX • ZAB SX	93	48
ZAC DX • ZAD SX	93	48

- Versione con struttura in finitura legno / Version with structure in wooden finish / Version mit Korpus in Holzfinish / Version avec structure finition bois / Versión con estructura en acabado madera

Accessori compresi / Included accessories

Piletta / Waste	Copri piletta in finitura/ Drain cover in finish	Troppo pieno / Overflow
Art. 54E	Cristalplant	No

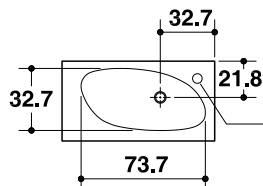

Foro rubinetto a richiesta - Compreso
Hole drilling on request - Free of charge

MOBILE 2 CASSETTI, TOP INTEGRATO SHAPE / UNIT WITH 2 DRAWERS AND SHAPE BUILT-IN BASIN / MÖBEL MIT 2 SCHUBLADEN UND WASCHTISCH SHAPE / MEUBLE AVEC 2 TIROIRS ET PLAN VASQUE INTÉGRÉE SHAPE / MUEBLE CON 2 CAJONES Y LAVABO I

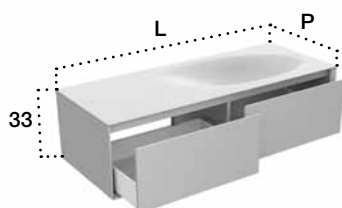

VERSIONE DX / RIGHT VERSION

Art.	L	P
ZAE DX • ZAF SX	123	48
ZAG DX • ZAH SX	123	48

- Versione con struttura in finitura legno / Version with structure in wooden finish / Version mit Korpus in Holzfinish / Version avec structure finition bois / Versión con estructura en acabado madera

Accessori compresi / Included accessories

Piletta / Waste	Copri piletta in finitura/ Drain cover in finish	Troppo pieno / Overflow
Art. 54E	Cristalplant	No

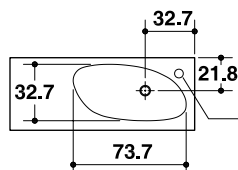

Foro rubinetto a richiesta - Compreso
Hole drilling on request - Free of charge

MOBILE 2 CASSETTI, TOP INTEGRATO SHAPE / UNIT WITH 2 DRAWERS AND SHAPE BUILT-IN BASIN / MÖBEL MIT 2 SCHUBLADE UND WASCHTISCH SHAPE / MEUBLE AVEC 2 TIROIRS ET PLAN VASQUE INTÉGRÉE SHAPE / MUEBLE CON 2 CAJONES Y LAVABO I

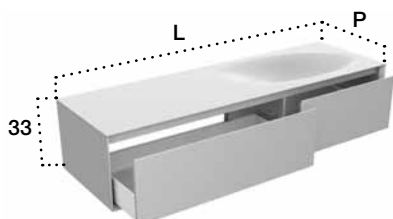

VERSIONE SX / LEFT VERSION

Art.	L	P
ZAI DX • ZAJ SX	153	48
ZAK DX • ZAL SX	153	48

- Versione con struttura in finitura legno / Version with structure in wooden finish / Version mit Korpus in Holzfinish / Version avec structure finition bois / Versión con estructura en acabado madera

Accessori compresi / Included accessories

Piletta / Waste	Copri piletta in finitura/ Drain cover in finish	Troppo pieno / Overflow
Art. 54E	Cristalplant	No

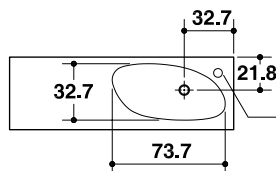

Foro rubinetto a richiesta - Compreso
Hole drilling on request - Free of charge

Maniglia a scelta (pag. 345) / Handle on choice (pg. 345) / Griffe nach Wahl (Seite 345) / Poignée au choix (pag. 345) / Tirador a elección (pág. 345)

MOBILI CON LAVABO SHAPE | MODULE WITH SHAPE BASIN

H 33

| MÖBEL MIT WASCHBECKEN SHAPE | MODULE AVEC LAVABO SHAPE | MUEBLE CON LAVABO SHAPE

MOBILE 3 CASSETTI, TOP INTEGRATO SHAPE / UNIT WITH 3 DRAWERS AND SHAPE BUILT-IN BASIN / MÖBEL MIT 3 SCHUBLADEN UND WASCHTISCH SHAPE / MEUBLE AVEC 3 TIROIRS ET PLAN VASQUE INTÉGRÉE SHAPE / MUEBLE CON 3 CAJONES Y LAVABO INTEGRADO SHAPE

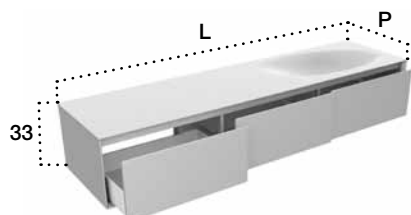

VERSIONE DX / RIGHT VERSION

Art.	L	P
ZAM DX • ZAN SX	183	48
ZAO DX • ZAP SX	183	48

■ **Versione con struttura in finitura legno** / Version with structure in wooden finish / Version mit Korpus in Holzfinish / Version avec structure finition bois / Versión con estructura en acabado madera

Accessori compresi / Included accessories

Piletta / Waste Art. 54E	Copri piletta in finitura/ Drain cover in finish Cristalplant	Troppo pieno / Overflow No

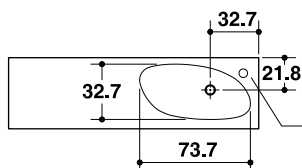

Foro rubinetto a richiesta - Compreso
Hole drilling on request - Free of charge

MOBILE 3 CASSETTI, TOP INTEGRATO SHAPE DOPPIO / UNIT WITH 3 DRAWERS AND SHAPE BUILT-IN BASIN / MÖBEL MIT 3 SCHUBLADE UND DOPPELWASCHTISCH SHAPE / MEUBLE AVEC 3 TIROIRS ET PLAN VASQUE INTÉGRÉE DOUBLE VASQUE SHAPE / MUEBLE CON 3 CAJONES Y LAVABO I

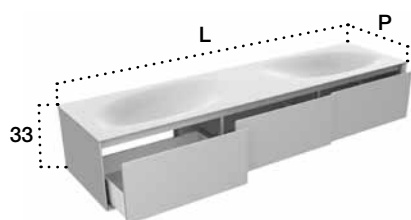

Art.	L	P
ZAQ	183	48
ZAR	183	48

■ **Versione con struttura in finitura legno** / Version with structure in wooden finish / Version mit Korpus in Holzfinish / Version avec structure finition bois / Versión con estructura en acabado madera

Accessori compresi / Included accessories

Piletta / Waste Art. 54E	Copri piletta in finitura/ Drain cover in finish Cristalplant	Troppo pieno / Overflow No

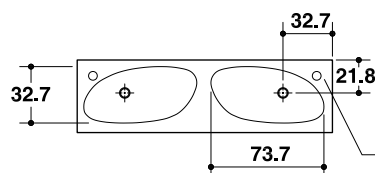

Foro rubinetto a richiesta - Compreso
Hole drilling on request - Free of charge

Maniglia a scelta (pag. 345) / Handle on choice (pg. 345) / Griffe nach Wahl (Seite 345) / Poignée au choix (pag. 345) / Tirador a elección (pág. 345)

MOBILI CON LAVABO LARGE | MODULE WITH LARGE BASIN

| MÖBEL MIT WASCHBECKEN LARGE | MODULE AVEC LAVABO LARGE | MUEBLE CON LAVABO LARGE

H 33

MOBILE 1 CASSETTO, TOP INTEGRATO LARGE / UNIT WITH 1 DRAWER AND LARGE BUILT-IN BASIN / MÖBEL MIT 1 SCHUBLADE UND WASCHTISCH LARGE / MEUBLE AVEC 1 TIROIR ET PLAN VASQUE INTÉGRÉE LARGE / MUEBLE CON 1 CAJON Y LAVABO INTEGRADO LARGE

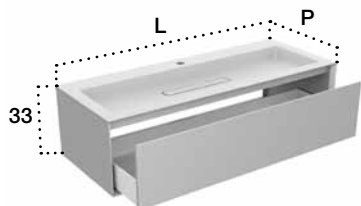

Art.	L	P
ZMA	123	48
ZMB	123	48

- Versione con struttura in finitura legno / Version with structure in wooden finish / Version mit Korpus in Holzfinish / Version avec structure finition bois / Versión con estructura en acabado madera

Accessori compresi / Included accessories

Piletta / Waste Inclusa / Included	Copri piletta in finitura/ Drain cover in finish Cristalplant	Troppo pieno / Overflow No

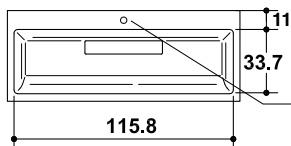

Foro rubinetto a richiesta - Compreso
Hole drilling on request - Free of charge

MOBILE 2 CASSETTI, TOP INTEGRATO LARGE / UNIT WITH 2 DRAWERS AND LARGE BUILT-IN BASIN / MÖBEL MIT 2 SCHUBLADE UND WASCHTISCH LARGE / MEUBLE AVEC 2 TIROIRS ET PLAN VASQUE INTÉGRÉE LARGE / MUEBLE CON 2 CAJONES Y LAVABO INTEGRADO LARGE

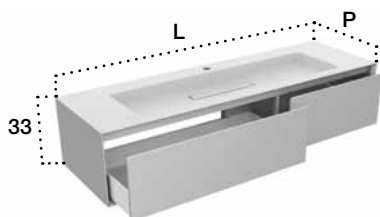

Art.	L	P
ZMC	153	48
ZMD	153	48

- Versione con struttura in finitura legno / Version with structure in wooden finish / Version mit Korpus in Holzfinish / Version avec structure finition bois / Versión con estructura en acabado madera

Accessori compresi / Included accessories

Piletta / Waste Inclusa / Included	Copri piletta in finitura/ Drain cover in finish Cristalplant	Troppo pieno / Overflow No

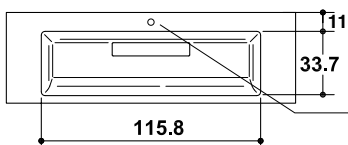

Foro rubinetto a richiesta - Compreso
Hole drilling on request - Free of charge

MOBILE 2 CASSETTI, TOP INTEGRATO LARGE / UNIT WITH 2 DRAWERS AND LARGE BUILT-IN BASIN / MÖBEL MIT 2 SCHUBLADE UND WASCHTISCH LARGE / MEUBLE AVEC 2 TIROIRS ET PLAN VASQUE INTÉGRÉE LARGE / MUEBLE CON 2 CAJONES Y LAVABO INTEGRADO LARGE

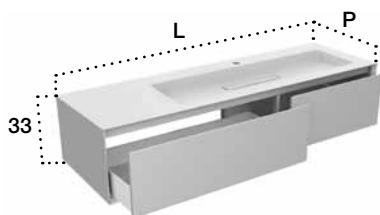

Art.	L	P
ZMG DX • ZMH SX	153	48
ZMI DX • ZMJ SX	153	48

- Versione con struttura in finitura legno / Version with structure in wooden finish / Version mit Korpus in Holzfinish / Version avec structure finition bois / Versión con estructura en acabado madera

Accessori compresi / Included accessories

Piletta / Waste Inclusa / Included	Copri piletta in finitura/ Drain cover in finish Cristalplant	Troppo pieno / Overflow No

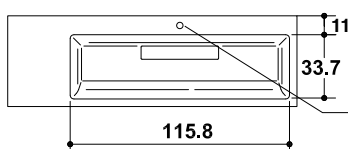

Foro rubinetto a richiesta - Compreso
Hole drilling on request - Free of charge

VERSIONE DX / RIGHT VERSION

Maniglia a scelta (pag. 345) / Handle on choice (pg. 345) / Griffe nach Wahl (Seite 345) / Poignée au choix (pag. 345) / Tirador a elección (pág. 345)

MOBILI CON LAVABO LARGE | MODULE WITH LARGE BASIN

H 33

| MÖBEL MIT WASCHBECKEN LARGE | MODULE AVEC LAVABO LARGE | MUEBLE CON LAVABO LARGE

MOBILE 3 CASSETTI, TOP INTEGRATO LARGE / UNIT WITH 3 DRAWERS AND LARGE BUILT-IN BASIN / MÖBEL MIT 3 SCHUBLADEN UND WASCHTISCH LARGE / MEUBLE AVEC 3 TIROIRS ET PLAN VASQUE INTÉGRÉE LARGE / MUEBLE CON 3 CAJONES Y LAVABO INTEGRADO LARGE

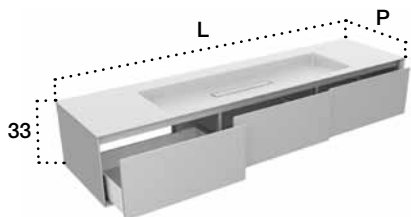

Art.	L	P
ZMK	183	48
ZML	183	48

■ **Versione con struttura in finitura legno** / *Version with structure in wooden finish* / *Version mit Korpus in Holzfinish* / *Version avec structure finition bois* / *Versión con estructura en acabado madera*

Accessori compresi / *Included accessories*

Piletta / Waste Inclusa / Included	Copri piletta in finitura/ Drain cover in finish Cristalplant	Troppo pieno / Overflow No

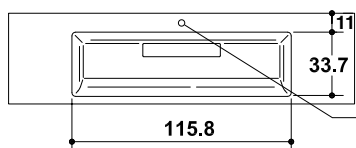

Foro rubinetto a richiesta - Compreso
Hole drilling on request - Free of charge

MOBILE 3 CASSETTI, TOP INTEGRATO LARGE / UNIT WITH 3 DRAWERS AND LARGE BUILT-IN BASIN / MÖBEL MIT 3 SCHUBLADEN UND WASCHTISCH LARGE / MEUBLE AVEC 3 TIROIRS ET PLAN VASQUE INTÉGRÉE LARGE / MUEBLE CON 3 CAJONES Y LAVABO I

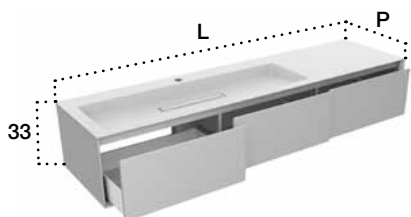

Art.	L	P
ZMM DX • ZMN SX	183	48
ZMO DX • ZMP SX	183	48

■ **Versione con struttura in finitura legno** / *Version with structure in wooden finish* / *Version mit Korpus in Holzfinish* / *Version avec structure finition bois* / *Versión con estructura en acabado madera*

Accessori compresi / *Included accessories*

Piletta / Waste Inclusa / Included	Copri piletta in finitura/ Drain cover in finish Cristalplant	Troppo pieno / Overflow No

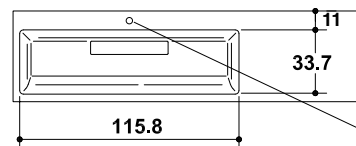

Foro rubinetto a richiesta - Compreso
Hole drilling on request - Free of charge

VERSIONE SX / LEFT VERSION

Maniglia a scelta (pag. 345) / *Handle on choice (pg. 345)* / Griffe nach Wahl (Seite 345) / *Poignée au choix (pag. 345)* / Tirador a elección (pág. 345)

MOBILI CON LAVABO HANDMADE | MODULE WITH HANDMADE BASIN

| MÖBEL MIT WASHBECKEN HANDMADE | MODULE AVEC LAVABO HANDMADE | MUEBLE CON LAVABO HANDMADE

H 33

HANDMADE

Lavabo compreso: art. D5N - Materiale: Cristalplant opaco
 Washbasin included: art. D5N - Material: Cristalplant matt
 Waschbecken inbegriffen: Art. D5N - Material: Cristalplant matt
 Lavabo inclus : art. D5N - Matériel : Cristalplant mat
 Lavabo incluido: art. D5N - Material: Cristalplant opaco

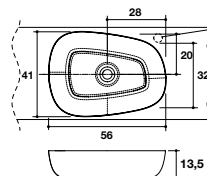

Foro rubinetto a richiesta
 Hole drilling on request

Compreso
 Free of charge

MOBILE 1 CASSETTO, TOP CRISTALPLANT E LAVABO D5N / UNIT WITH 1 DRAWER, CRISTALPLANT TOP AND D5N BASIN / MÖBEL MIT 1 SCHUBLADE, TOPPLATTE AUS CRISTALPLANT UND WASHBECKEN D5N / MEUBLE AVEC 1 TIROIR, PLAN EN CRISTALPLANT ET VASQUE D5N / MUEBLE CON 1 CAJON, ENCIMERA EN CRISTALPLANT Y LAVABO D5N

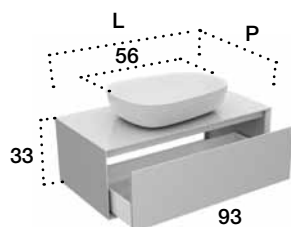

Art.	L	P
#A1	93	48
#B1	93	48

Versione con struttura in finitura legno / Version with structure in wooden finish / Version mit Korpus in Holzfinish /
 Version avec structure finition bois / Versión con estructura en acabado madera

Accessori compresi / Included accessories

Piletta / Waste	Copri piletta in finitura/ Drain cover in finish	Troppo pieno / Overflow
Art. 66A	Cristalplant	

MOBILE 2 CASSETTI, TOP CRISTALPLANT E LAVABO D5N / UNIT WITH 2 DRAWERS, CRISTALPLANT TOP AND D5N BASIN / MÖBEL MIT 2 SCHUBLADEN, TOPPLATTE AUS CRISTALPLANT UND WASHBECKEN D5N / MEUBLE AVEC 2 TIROIRS, PLAN EN CRISTALPLANT ET VASQUE D5N / MUEBLE CON 2 CAJONES, ENCIMERA EN CRISTALPL

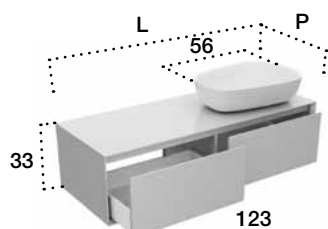

VERSIONE DX / RIGHT VERSION

Art.	L	P
#A3 DX • #A4 SX	123	48
#B3 DX • #B4 SX	123	48

Versione con struttura in finitura legno / Version with structure in wooden finish / Version mit Korpus in Holzfinish /
 Version avec structure finition bois / Versión con estructura en acabado madera

Accessori compresi / Included accessories

Piletta / Waste	Copri piletta in finitura/ Drain cover in finish	Troppo pieno / Overflow
Art. 66A	Cristalplant	

MOBILE 2 CASSETTI, TOP CRISTALPLANT E LAVABO D5N / UNIT WITH 2 DRAWERS, CRISTALPLANT TOP AND D5N BASIN / MÖBEL MIT 2 SCHUBLADEN, TOPPLATTE AUS CRISTALPLANT UND WASHBECKEN D5N / MEUBLE AVEC 2 TIROIRS, PLAN EN CRISTALPLANT ET VASQUE D5N / MUEBLE CON 2 CAJONES, ENCIMERA EN CRISTALPL

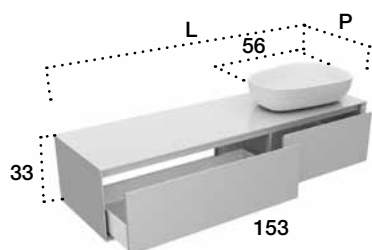

VERSIONE DX / RIGHT VERSION

Art.	L	P
#A5 DX • #A6 SX	153	48
#B5 DX • #B6 SX	153	48

Versione con struttura in finitura legno / Version with structure in wooden finish / Version mit Korpus in Holzfinish /
 Version avec structure finition bois / Versión con estructura en acabado madera

Accessori compresi / Included accessories

Piletta / Waste	Copri piletta in finitura/ Drain cover in finish	Troppo pieno / Overflow
Art. 66A	Cristalplant	

Maniglia a scelta (pag. 345) / Handle on choice (pg. 345) / Griffe nach Wahl (Seite 345) / Poignée au choix (pag. 345) / Tirador a elección (pág. 345)

MOBILI CON LAVABO HANDMADE | MODULE WITH HANDMADE BASIN

H 33

| MÖBEL MIT WASCHBECKEN HANDMADE | MODULE AVEC LAVABO HANDMADE | MUEBLE CON LAVABO HANDMADE

HANDMADE

Lavabo compreso: art. D5N - Materiale: Cristalplant opaco
 Washbasin included: art. D5N - Material: Cristalplant matt
 Waschbecken inbegriffen: Art. D5N - Material: Cristalplant matt
 Lavabo inclus : art. D5N - Matériel : Cristalplant mat
 Lavabo incluido: art. D5N - Material: Cristalplant opaco

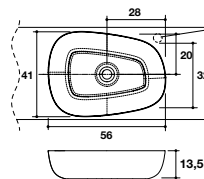

Foro rubinetto a richiesta
 Hole drilling on request

Compreso
 Free of charge

MOBILE 3 CASSETTI, TOP CRISTALPLANT E LAVABO D5N / UNIT WITH 3 DRAWERS, CRISTALPLANT TOP AND D5N BASIN / MÖBEL MIT 3 SCHUBLADEN, TOPPLATTE AUS CRISTALPLANT UND WASCHBECKEN D5N / MEUBLE AVEC 3 TIROIRS, PLAN EN CRISTALPLANT ET VASQUE D5N / MUEBLE CON 3 CAJONES, ENCIMERA EN CRISTALPLANT Y LAVABO D5N

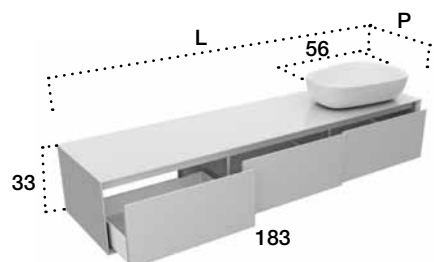

VERSIONE DX / RIGHT VERSION

Art.	L	P
#A7 DX • #A8 SX	183	48
#B7 DX • #B8 SX	183	48

Versione con struttura in finitura legno / Version with structure in wooden finish / Version mit Korpus in Holzfinish / Version avec structure finition bois / Versión con estructura en acabado madera

Accessori compresi / Included accessories

Piletta / Waste	Copri piletta in finitura/ Drain cover in finish	Troppo pieno / Overflow
Art. 66A	Cristalplant	

MOBILE 3 CASSETTI, TOP CRISTALPLANT E 2 LAVABI D5N / UNIT WITH 3 DRAWERS, CRISTALPLANT TOP AND 2 D5N BASINS / MÖBEL MIT 3 SCHUBLADEN, TOPPLATTE AUS CRISTALPLANT UND 2 WASCHBECKEN D5N / MEUBLE AVEC 3 TIROIRS, PLAN EN CRISTALPLANT ET 2 VASQUES D5N / MUEBLE CON 3 CAJONES, ENCIMERA EN CRISTALPLANT Y 2 LAVABOS D5N

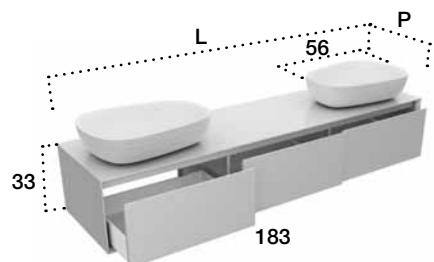

Art.	L	P
#A9	183	48
#B9	183	48

Versione con struttura in finitura legno / Version with structure in wooden finish / Version mit Korpus in Holzfinish / Version avec structure finition bois / Versión con estructura en acabado madera

Accessori compresi / Included accessories

Piletta / Waste	Copri piletta in finitura/ Drain cover in finish	Troppo pieno / Overflow
Art. 66A	Cristalplant	

Maniglia a scelta (pag. 345) / Handle on choice (pg. 345) / Griffe nach Wahl (Seite 345) / Poignée au choix (pag. 345) / Tirador a elección (pág. 345)

MOBILI CON TOP SHAPE | MODULE WITH SHAPE TOP

| MÖBEL MIT TOP SHAPE | MODULE AVEC PLAN SHAPE | MUEBLE CON ENCIMERA SHAPE

H 33

SHAPE

Piano integrato compreso: art. DMC e DME - Materiale: Cristalplant Biobased
 Integrated top included: art. DMC and DME - Material: Cristalplant Biobased
 Integrierter Top inbegriffen: Art. DMC und DME - Material: Cristalplant Biobased
 Plan vasque intégrée inclus : art. DMC et DME - Matériel : Cristalplant Biobased
 Encimera integrada incluida: art. DMC y DME - Material: Cristalplant Biobased

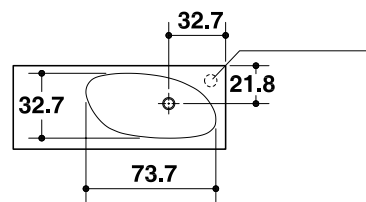

Foro rubinetto a richiesta
 Hole drilling on request

Compreso
 Free of charge

MOBILE 1 CASSETTO, TOP INTEGRATO SHAPE H10 / UNIT WITH 1 DRAWER AND BUILT-IN BASIN SHAPE H10 / MÖBEL MIT 1 SCHUBLADE UND WASCHTISCH SHAPE H10 / MEUBLE AVEC 1 TIROIR ET PLAN VASQUE INTÉGRÉE SHAPE H10 / MUEBLE CON 1 CAJON Y LAVABO INTEGRADO SHAPE H10

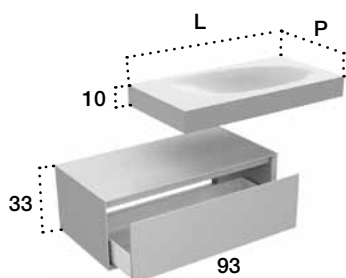

VERSIONE DX / RIGHT VERSION

Art.	L	P
#64 DX • #65 SX	93	48
#30 DX • #31 SX	93	48

Versione con struttura in finitura legno / Version with structure in wooden finish / Version mit Korpus in Holzfinish / Version avec structure finition bois / Versión con estructura en acabado madera

Accessori compresi / Included accessories

Piletta / Waste	Copri piletta in finitura/ Drain cover in finish	Troppo pieno / Overflow
Art. 54E	Cristalplant	

MOBILE 2 CASSETTI, TOP INTEGRATO SHAPE H10 / UNIT WITH 2 DRAWERS AND BUILT-IN BASIN SHAPE H10 / MÖBEL MIT 2 SCHUBLADEN UND WASCHTISCH SHAPE H10 / MEUBLE AVEC 2 TIROIRS ET PLAN VASQUE INTÉGRÉE SHAPE H10 / MUEBLE CON 2 CAJONES Y LAVABO

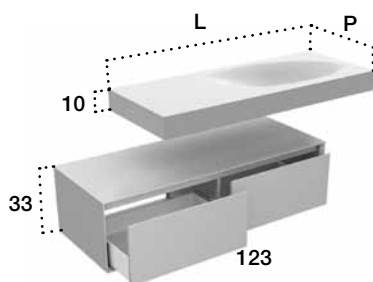

VERSIONE DX / RIGHT VERSION

Art.	L	P
#66 DX • #67 SX	123	48
#32 DX • #33 SX	123	48

Versione con struttura in finitura legno / Version with structure in wooden finish / Version mit Korpus in Holzfinish / Version avec structure finition bois / Versión con estructura en acabado madera

Accessori compresi / Included accessories

Piletta / Waste	Copri piletta in finitura/ Drain cover in finish	Troppo pieno / Overflow
Art. 54E	Cristalplant	

MOBILE 2 CASSETTI, TOP INTEGRATO SHAPE H10 / UNIT WITH 2 DRAWERS AND BUILT-IN BASIN SHAPE H10 / MÖBEL MIT 2 SCHUBLADEN UND WASCHTISCH SHAPE H10 / MEUBLE AVEC 2 TIROIRS ET PLAN VASQUE INTÉGRÉE SHAPE H10 / MUEBLE CON 2 CAJONES Y LAVABO

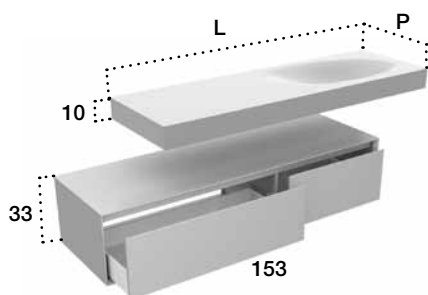

VERSIONE DX / RIGHT VERSION

Art.	L	P
#68 DX • #69 SX	153	48
#34 DX • #35 SX	153	48

Versione con struttura in finitura legno / Version with structure in wooden finish / Version mit Korpus in Holzfinish / Version avec structure finition bois / Versión con estructura en acabado madera

Accessori compresi / Included accessories

Piletta / Waste	Copri piletta in finitura/ Drain cover in finish	Troppo pieno / Overflow
Art. 54E	Cristalplant	

Maniglia a scelta (pag. 345) / Handle on choice (pg. 345) / Griffe nach Wahl (Seite 345) / Poignée au choix (pag. 345) / Tirador a elección (pág. 345)

Le staffe per il fissaggio del top sono comprese / Top fixing brackets are included / Die Fixierungsbügel für das Top sind inbegriffen / Les pattes de support sont comprises / Los soportes para sujetar el top están incluidos

MOBILI CON TOP SHAPE | MODULE WITH SHAPE TOP

| MÖBEL MIT TOP SHAPE | MODULE AVEC PLAN SHAPE | MUEBLE CON ENCIMERA SHAPE

H 33

SHAPE

Piano integrato compreso: art. DMC e DME - Materiale: Cristalplant Biobased
 Integrated top included: art. DMC and DME - Material: Cristalplant Biobased
 Integrierter Top inbegriffen: Art. DMC und DME - Material: Cristalplant Biobased
 Plan vasque intégrée inclus : art. DMC et DME - Matériel : Cristalplant Biobased
 Encimera integrada incluida: art. DMC y DME - Material: Cristalplant Biobased

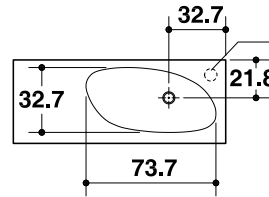

Foro rubinetto a richiesta
 Hole drilling on request

Compreso
 Free of charge

MOBILE 3 CASSETTI, TOP INTEGRATO SHAPE H10 / UNIT WITH 3 DRAWERS AND BUILT-IN BASIN SHAPE H10 / MÖBEL MIT 3 SCHUBLADEN UND WASCHTISCH SHAPE H10 / MEUBLE AVEC 3 TIROIRS ET PLAN VASQUE INTÉGRÉE SHAPE H10 / MUEBLE CON 3 CAJONES Y LAVABO INTEGRADO SHAPE H10

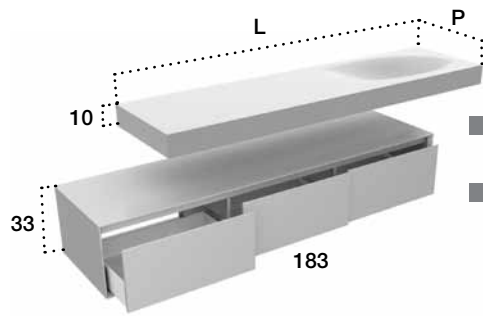

VERSIONE DX / RIGHT VERSION

Art.	L	P
#70 DX • #71 SX	183	48
#36 DX • #37 SX	183	48

Versione con struttura in finitura legno / Version with structure in wooden finish / Version mit Korpus in Holzfinish /
 Version avec structure finition bois / Versión con estructura en acabado madera

Accessori compresi / Included accessories

Piletta / Waste	Copri piletta in finitura/ Drain cover in finish	Troppo pieno / Overflow
Art. 54E	Cristalplant	

MOBILE 3 CASSETTI, TOP INTEGRATO SHAPE DOPPIO H10 / UNIT WITH 3 DRAWERS AND BUILT-IN DOUBLE BASIN SHAPE H10 / MÖBEL MIT 3 SCHUBLADEN UND DOPPELWASCHTISCH SHAPE H10 / MEUBLE AVEC 3 TIROIRS ET PLAN VASQUE INTÉGRÉE DOUBLE VASQUE SHAPE H10 / MUEBLE CON 3 CAJONES Y LAVABO INTEGRADO DOBLE SHAPE H10

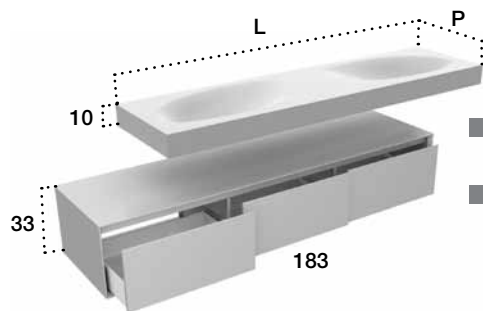

Art.	L	P
#72	183	48
#38	183	48

Versione con struttura in finitura legno / Version with structure in wooden finish / Version mit Korpus in Holzfinish /
 Version avec structure finition bois / Versión con estructura en acabado madera

Accessori compresi / Included accessories

Piletta / Waste	Copri piletta in finitura/ Drain cover in finish	Troppo pieno / Overflow
Art. 54E	Cristalplant	

Maniglia a scelta (pag. 345) / Handle on choice (pg. 345) / Griffe nach Wahl (Seite 345) / Poignée au choix (pag. 345) / Tirador a elección (pág. 345)

Le staffe per il fissaggio del top sono comprese / Top fixing brackets are included / Die Fixierungsbügel für das Top sind inbegriffen / Les pattes de support sont comprises / Los soportes para sujetar el top están incluidos

MOBILI CON TOP IN CRISTALPLANT | MODULE WITH CRISTALPLANT TOP

H 33

| MÖBEL MIT TOP AUS CRISTALPLANT | MODULE AVEC PLAN EN CRISTALPLANT | MUEBLE CON ENCIMERA DE CRISTALPLANT

BASE 1 CASSETTO CON TOP CRISTALPLANT / UNIT WITH 1 DRAWER AND CRISTALPLANT TOP / MODUL MIT 1 SCHUBLADE UND TOPPLATTE AUS CRISTALPLANT / MODULE AVEC 1 TIROIR ET PLAN EN CRISTALPLANT / MÓDULO CON 1 CAJÓN Y ENCIMERA EN CRISTALPLANT

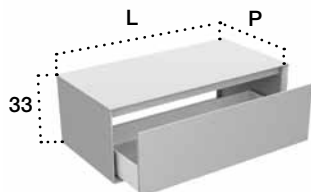

Art.	L	P
ZGA	93	48
ZGB	93	48

■ **Versione con struttura in finitura legno** / Version with structure in wooden finish / Version mit Korpus in Holzfinish / Version avec structure finition bois / Versión con estructura en acabado madera

BASE 2 CASSETTI CON TOP CRISTALPLANT / UNIT WITH 2 DRAWERS AND CRISTALPLANT TOP / MODUL MIT 2 SCHUBLADEN UND TOPPLATTE AUS CRISTALPLANT / MODULE AVEC 2 TIROIRS ET PLAN EN CRISTALPLANT / MÓDULO CON 2 CAJÓN Y ENCIMERA EN CRISTALPLANT

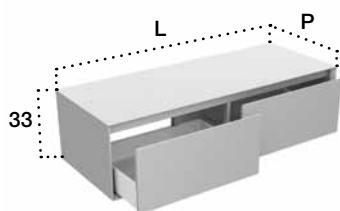

Art.	L	P
ZGD	123	48
ZGE	123	48

■ **Versione con struttura in finitura legno** / Version with structure in wooden finish / Version mit Korpus in Holzfinish / Version avec structure finition bois / Versión con estructura en acabado madera

BASE 2 CASSETTI CON TOP CRISTALPLANT / UNIT WITH 2 DRAWERS AND CRISTALPLANT TOP / MODUL MIT 2 SCHUBLADEN UND TOPPLATTE AUS CRISTALPLANT / MODULE AVEC 2 TIROIRS ET PLAN EN CRISTALPLANT / MÓDULO CON 2 CAJÓNES Y ENCIMERA EN CRISTALPLANT

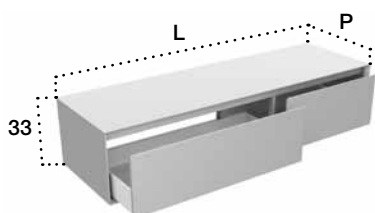

Art.	L	P
ZGG	153	48
ZGH	153	48

■ **Versione con struttura in finitura legno** / Version with structure in wooden finish / Version mit Korpus in Holzfinish / Version avec structure finition bois / Versión con estructura en acabado madera

BASE 3 CASSETTI CON TOP CRISTALPLANT / UNIT WITH 3 DRAWERS AND CRISTALPLANT TOP / MODUL MIT 3 SCHUBLADEN UND TOPPLATTE AUS CRISTALPLANT / MODULE AVEC 3 TIROIRS ET PLAN EN CRISTALPLANT / MÓDULO CON 3 CAJÓNES Y ENCIMERA EN CRISTALPLANT

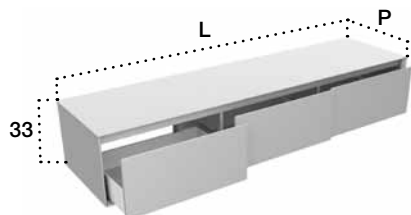

Art.	L	P
ZGJ	183	48
ZGK	183	48

■ **Versione con struttura in finitura legno** / Version with structure in wooden finish / Version mit Korpus in Holzfinish / Version avec structure finition bois / Versión con estructura en acabado madera

DSS Sovrapprezzo foratura per lavabo / Additional charge for basin hole / Aufpreis für Waschbeckenbohrung / Majoration pour trous lavabo / Suplemento precio para orificio lavabo

Maniglia a scelta (pag. 345) / Handle on choice (pg. 345) / Griffe nach Wahl (Seite 345) / Poignée au choix (pag. 345) / Tirador a elección (pág. 345)

MOBILI CON TOP LEGNO | MODULE WITH WOODEN TOP

H 33

| MODUL MIT TOP AUS HOLZ | MODULE AVEC PLAN S EN BOIS | MUEBLE CON ENCIMERA DE MADERA

BASE 1 CASSETTO CON TOP LEGNO / UNIT WITH 1 DRAWER AND WOODEN TOP / MODUL MIT 1 SCHUBLADE UND TOPPLATTE AUS HOLZ / MODULE AVEC 1 TIROIR ET PLAN EN BOIS / MODULO CON 1 CAJÓN Y ENCIMERA EN MADERA

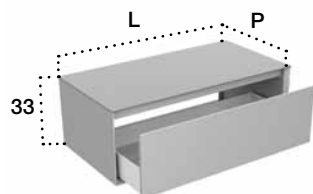

Art.	L	P
ZKA	93	48
ZKB	93	48

■ **Versione con struttura in finitura legno** / Version with structure in wooden finish / Version mit Korpus in Holzfinish / Version avec structure finition bois / Versión con estructura en acabado madera

BASE 2 CASSETTI CON TOP LEGNO / UNIT WITH 2 DRAWERS AND WOODEN TOP / MODUL MIT 2 SCHUBLADEN UND TOPPL / MODULE AVEC 2 TIROIRS ET PLAN EN BOIS / MODULO CON 2 CAJÓNES Y ENCIMERA EN MADERA

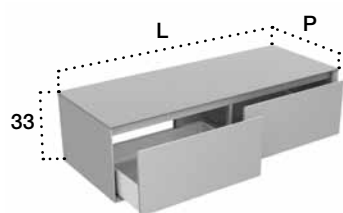

Art.	L	P
ZKC	123	48
ZKD	123	48

■ **Versione con struttura in finitura legno** / Version with structure in wooden finish / Version mit Korpus in Holzfinish / Version avec structure finition bois / Versión con estructura en acabado madera

BASE 2 CASSETTI CON TOP LEGNO / UNIT WITH 2 DRAWERS AND WOODEN TOP / MODUL MIT 2 SCHUBLADEN UND TOPPL / MODULE AVEC 2 TIROIRS ET PLAN EN BOIS / MODULO CON 2 CAJÓNES Y ENCIMERA EN MADERA

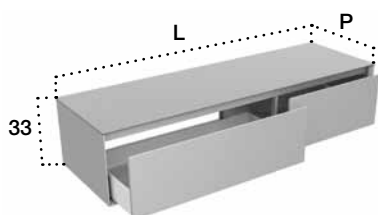

Art.	L	P
ZKE	153	48
ZKF	153	48

■ **Versione con struttura in finitura legno** / Version with structure in wooden finish / Version mit Korpus in Holzfinish / Version avec structure finition bois / Versión con estructura en acabado madera

BASE 3 CASSETTI CON TOP LEGNO / UNIT WITH 3 DRAWERS AND WOODEN TOP / MODUL MIT 3 SCHUBLADEN UND TOPPL / MODULE AVEC 3 TIROIRS ET PLAN EN BOIS / MODULO CON 3 CAJÓNES Y ENCIMERA EN MADERA

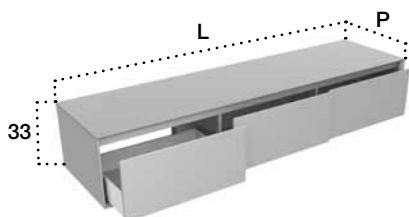

Art.	L	P
ZKG	183	48
ZKH	183	48

■ **Versione con struttura in finitura legno** / Version with structure in wooden finish / Version mit Korpus in Holzfinish / Version avec structure finition bois / Versión con estructura en acabado madera

DSS Sovrapprezzo foratura per lavabo / Additional charge for basin hole / Aufpreis für Waschbeckenbohrung / Majoration pour trous lavabo / Suplemento precio para orificio lavabo

Maniglia a scelta (pag. 345) / Handle on choice (pg. 345) / Griffe nach Wahl (Seite 345) / Poignée au choix (pag. 345) / Tirador a elección (pág. 345)

MOBILI CON LAVABO SHAPE | MODULE WITH SHAPE BASIN

| MÖBEL MIT WASCHBECKEN SHAPE | MODULE AVEC LAVABO SHAPE | MUEBLE CON LAVABO SHAPE

H 50

MOBILE 1 CASSETTO, TOP INTEGRATO SHAPE / UNIT WITH 1 DRAWER AND SHAPE BUILT-IN BASIN / MÖBEL MIT 1 SCHUBLADE UND WASCHTISCH SHAPE / MEUBLE AVEC 1 TIROIR ET PLAN VASQUE INTÉGRÉE SHAPE / MUEBLE CON 1 CAJON Y LAVABO INTEGRADO SHAPE

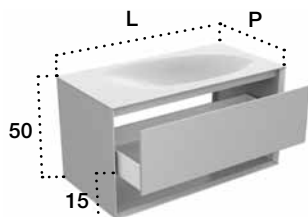

VERSIONE DX / RIGHT VERSION

Art.	L	P
ZBA DX • ZBB SX	93	48
ZBC DX • ZBD SX	93	48

- Versione con struttura in finitura legno / Version with structure in wooden finish / Version mit Korpus in Holzfinish / Version avec structure finition bois / Versión con estructura en acabado madera

Accessori compresi / Included accessories

Piletta / Waste Art. 54E	Copri piletta in finitura/ Drain cover in finish Cristalplant	Troppo pieno / Overflow No

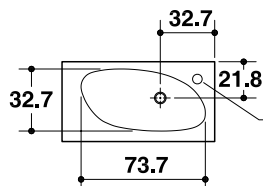

Foro rubinetto a richiesta - Compreso
Hole drilling on request - Free of charge

MOBILE 2 CASSETTI, TOP INTEGRATO SHAPE / UNIT WITH 2 DRAWERS AND SHAPE BUILT-IN BASIN / MÖBEL MIT 2 SCHUBLADEN UND WASCHTISCH SHAPE / MEUBLE AVEC 2 TIROIRS ET PLAN VASQUE INTÉGRÉE SHAPE / MUEBLE CON 2 CAJONES Y LAVABO I

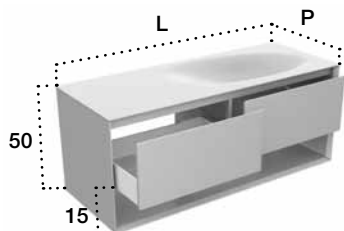

VERSIONE DX / RIGHT VERSION

Art.	L	P
ZBE DX • ZBF SX	123	48
ZBG DX • ZBH SX	123	48

- Versione con struttura in finitura legno / Version with structure in wooden finish / Version mit Korpus in Holzfinish / Version avec structure finition bois / Versión con estructura en acabado madera

Accessori compresi / Included accessories

Piletta / Waste Art. 54E	Copri piletta in finitura/ Drain cover in finish Cristalplant	Troppo pieno / Overflow No

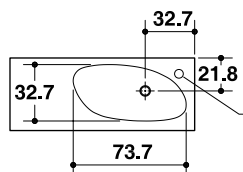

Foro rubinetto a richiesta - Compreso
Hole drilling on request - Free of charge

MOBILE 2 CASSETTI, TOP INTEGRATO SHAPE / UNIT WITH 2 DRAWERS AND SHAPE BUILT-IN BASIN / MÖBEL MIT 2 SCHUBLADE UND WASCHTISCH SHAPE / MEUBLE AVEC 2 TIROIRS ET PLAN VASQUE INTÉGRÉE SHAPE / MUEBLE CON 2 CAJONES Y LAVABO INTEGRADO SHAPE

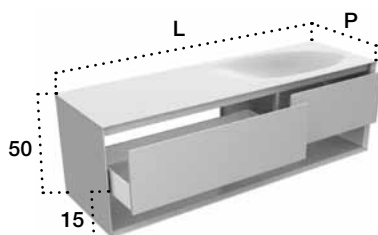

VERSIONE DX / RIGHT VERSION

Art.	L	P
ZBI DX • ZBJ SX	153	48
ZBK DX • ZBL SX	153	48

- Versione con struttura in finitura legno / Version with structure in wooden finish / Version mit Korpus in Holzfinish / Version avec structure finition bois / Versión con estructura en acabado madera

Accessori compresi / Included accessories

Piletta / Waste Art. 54E	Copri piletta in finitura/ Drain cover in finish Cristalplant	Troppo pieno / Overflow No

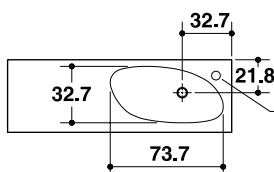

Foro rubinetto a richiesta - Compreso
Hole drilling on request - Free of charge

Maniglia a scelta (pag. 345) / Handle on choice (pg. 345) / Griffe nach Wahl (Seite 345) / Poignée au choix (pag. 345) / Tirador a elección (pág. 345)

MOBILI CON LAVABO SHAPE | MODULE WITH SHAPE BASIN

H 50

| MÖBEL MIT WASCHBECKEN SHAPE | MODULE AVEC LAVABO SHAPE | MUEBLE CON LAVABO SHAPE

MOBILE 3 CASSETTI, TOP INTEGRATO SHAPE / UNIT WITH 3 DRAWERS AND SHAPE BUILT-IN BASIN / MÖBEL MIT 3 SCHUBLADEN UND WASCHTISCH SHAPE / MEUBLE AVEC 3 TIROIRS ET PLAN VASQUE INTÉGRÉE SHAPE / MUEBLE CON 3 CAJONES Y LAVABO INTEGRADO SHAPE

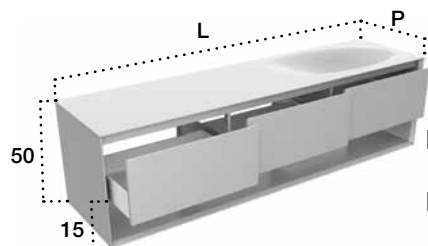

VERSIONE DX / RIGHT VERSION

Art.	L	P
ZBM DX • ZBN SX	183	48
ZBO DX • ZBP SX	183	48

■ **Versione con struttura in finitura legno** / Version with structure in wooden finish / Version mit Korpus in Holzfinish / Version avec structure finition bois / Versión con estructura en acabado madera

Accessori compresi / Included accessories

Piletta / Waste	Copri piletta in finitura/ Drain cover in finish	Troppo pieno / Overflow
Art. 54E	Cristalplant	No

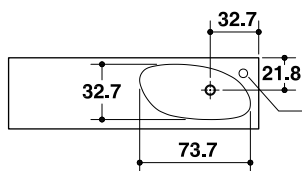

Foro rubinetto a richiesta - Compreso
Hole drilling on request - Free of charge

MOBILE 3 CASSETTI, TOP INTEGRATO SHAPE DOPPIO / UNIT WITH 3 DRAWERS AND SHAPE BUILT-IN BASIN / MÖBEL MIT 3 SCHUBLADEN UND DOPPELWASCHTISCH SHAPE / MEUBLE AVEC 3 TIROIRS ET PLAN VASQUE INTÉGRÉE DOUBLE VASQUE SHAPE / MUEBLE CON 3 CAJONES Y LAVABO I

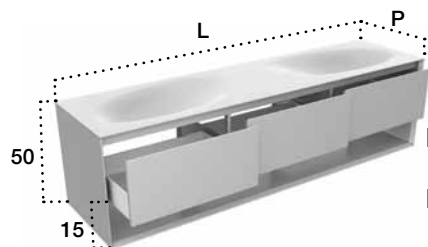

Art.	L	P
ZBQ	183	48
ZBR	183	48

■ **Versione con struttura in finitura legno** / Version with structure in wooden finish / Version mit Korpus in Holzfinish / Version avec structure finition bois / Versión con estructura en acabado madera

Accessori compresi / Included accessories

Piletta / Waste	Copri piletta in finitura/ Drain cover in finish	Troppo pieno / Overflow
Art. 54E	Cristalplant	No

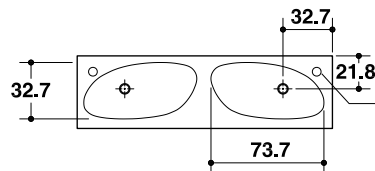

Foro rubinetto a richiesta - Compreso
Hole drilling on request - Free of charge

Maniglia a scelta (pag. 345) / Handle on choice (pg. 345) / Griffe nach Wahl (Seite 345) / Poignée au choix (pag. 345) / Tirador a elección (pág. 345)

MOBILI CON LAVABO LARGE | MODULE WITH LARGE BASIN

| MÖBEL MIT WASCHBECKEN LARGE | MODULE AVEC LAVABO LARGE | MUEBLE CON LAVABO LARGE

H 50

MOBILE 1 CASSETTO, TOP INTEGRATO LARGE / UNIT WITH 1 DRAWER AND LARGE BUILT-IN BASIN / MÖBEL MIT 1 SCHUBLADE UND WASCHTISCH LARGE / MEUBLE AVEC 1 TIROIR ET PLAN VASQUE INTÉGRÉE LARGE / MUEBLE CON 1 CAJON Y LAVABO INTEGRADO LARGE

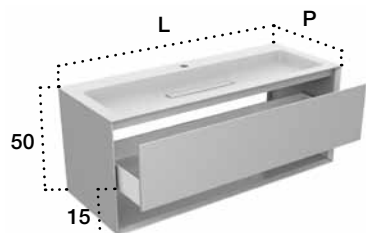

Art.	L	P
ZNA	123	48
ZNB	123	48

- Versione con struttura in finitura legno / Version with structure in wooden finish / Version mit Korpus in Holzfinish / Version avec structure finition bois / Versión con estructura en acabado madera

Accessori compresi / Included accessories

Piletta / Waste Inclusa / Included	Copri piletta in finitura/ Drain cover in finish Cristalplant	Troppo pieno / Overflow No

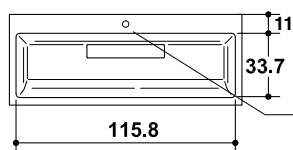

Foro rubinetto a richiesta - Compreso
Hole drilling on request - Free of charge

MOBILE 2 CASSETTI, TOP INTEGRATO LARGE / UNIT WITH 2 DRAWERS AND LARGE BUILT-IN BASIN / MÖBEL MIT 2 SCHUBLADEN UND WASCHTISCH LARGE / MEUBLE AVEC 2 TIROIRS ET PLAN VASQUE INTÉGRÉE LARGE / MUEBLE CON 2 CAJONES Y LAVABO I

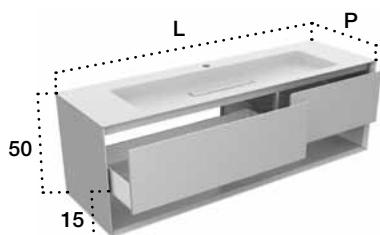

Art.	L	P
ZNC	153	48
ZND	153	48

- Versione con struttura in finitura legno / Version with structure in wooden finish / Version mit Korpus in Holzfinish / Version avec structure finition bois / Versión con estructura en acabado madera

Accessori compresi / Included accessories

Piletta / Waste Inclusa / Included	Copri piletta in finitura/ Drain cover in finish Cristalplant	Troppo pieno / Overflow No

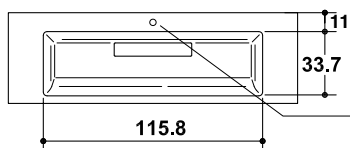

Foro rubinetto a richiesta - Compreso
Hole drilling on request - Free of charge

MOBILE 2 CASSETTI, TOP INTEGRATO LARGE / UNIT WITH 2 DRAWERS AND LARGE BUILT-IN BASIN / MÖBEL MIT 2 SCHUBLADE UND WASCHTISCH LARGE / MEUBLE AVEC 2 TIROIRS ET PLAN VASQUE INTÉGRÉE LARGE / MUEBLE CON 2 CAJONES Y LAVABO INTEGRADO LARGE

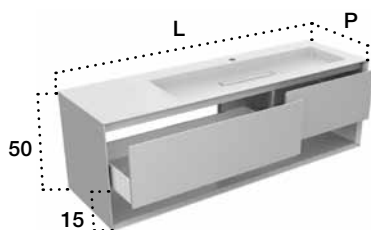

Art.	L	P
ZNG DX • ZNH SX	153	48
ZNI DX • ZNJ SX	153	48

- Versione con struttura in finitura legno / Version with structure in wooden finish / Version mit Korpus in Holzfinish / Version avec structure finition bois / Versión con estructura en acabado madera

Accessori compresi / Included accessories

Piletta / Waste Inclusa / Included	Copri piletta in finitura/ Drain cover in finish Cristalplant	Troppo pieno / Overflow No

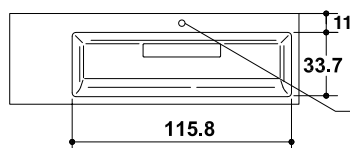

Foro rubinetto a richiesta - Compreso
Hole drilling on request - Free of charge

VERSIONE SX / LEFT VERSION

Maniglia a scelta (pag. 345) / Handle on choice (pg. 345) / Griffe nach Wahl (Seite 345) / Poignée au choix (pag. 345) / Tirador a elección (pág. 345)

MOBILI CON LAVABO LARGE | MODULE WITH LARGE BASIN

H 50

MOBILE 3 CASSETTI, TOP INTEGRATO LARGE / UNIT WITH 3 DRAWERS AND LARGE BUILT-IN BASIN / MÖBEL MIT 3 SCHUBLADEN UND WASCHTISCH LARGE / MEUBLE AVEC 3 TIROIRS ET PLAN VASQUE INTÉGRÉE LARGE / MUEBLE CON 3 CAJONES Y LAVABO INTEGRADO LARGE

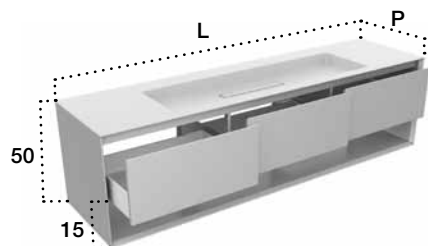

Art.	L	P
ZNK	183	48
ZNL	183	48

■ **Versione con struttura in finitura legno** / Version with structure in wooden finish / Version mit Korpus in Holzfinish / Version avec structure finition bois / Versión con estructura en acabado madera

Accessori compresi / Included accessories

Piletta / Waste	Copri piletta in finitura/ Drain cover in finish	Troppo pieno / Overflow
Inclusa / Included	Cristalplant	No

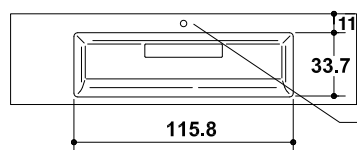

Foro rubinetto a richiesta - Compreso
Hole drilling on request - Free of charge

MOBILE 3 CASSETTI, TOP INTEGRATO LARGE / UNIT WITH 3 DRAWERS AND LARGE BUILT-IN BASIN / MÖBEL MIT 3 SCHUBLADEN UND WASCHTISCH LARGE / MEUBLE AVEC 3 TIROIRS ET PLAN VASQUE INTÉGRÉE LARGE / MUEBLE CON 3 CAJONES Y LAVABO INTEGRADO LARGE

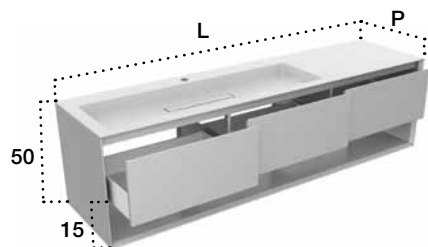

Art.	L	P
ZNM DX • ZNN SX	183	48
ZNO DX • ZNP SX	183	48

■ **Versione con struttura in finitura legno** / Version with structure in wooden finish / Version mit Korpus in Holzfinish / Version avec structure finition bois / Versión con estructura en acabado madera

Accessori compresi / Included accessories

Piletta / Waste	Copri piletta in finitura/ Drain cover in finish	Troppo pieno / Overflow
Inclusa / Included	Cristalplant	No

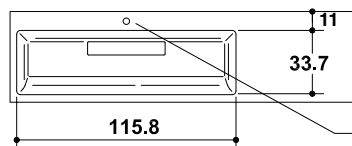

Foro rubinetto a richiesta - Compreso
Hole drilling on request - Free of charge

VERSIONE SX / LEFT VERSION

Maniglia a scelta (pag. 345) / Handle on choice (pg. 345) / Griffe nach Wahl (Seite 345) / Poignée au choix (pag. 345) / Tirador a elección (pág. 345)

falper.

Modello: SHAPE EVO

Articolo: ZAA

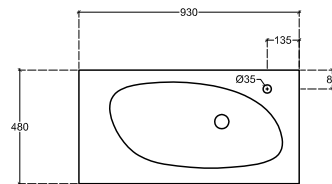
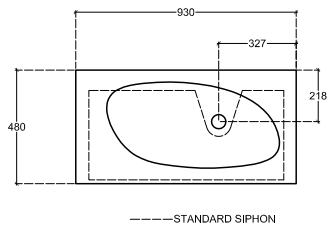
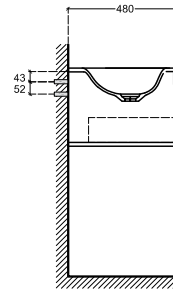
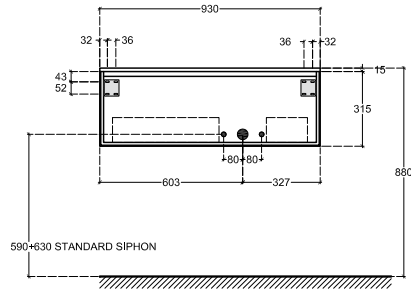

DISEGNI TECNICI CON POSIZIONAMENTO IMPIANTI DISPONIBILI SUL SITO WEB
TECHNICAL DRAWINGS WITH DIMENSIONS AVAILABLE ON OUR WEB SITE
TECHNISCHE DATENBLÄTTER MIT MASSEN AUF UNSERER WEBSITE
FICHES TECHNIQUES AVEC DIMENSIONS DISPONIBLES SUR NOTRE SITE WEB
DIBUJOS TÉCNICOS CON MEDIDAS DISPONIBLES EN NUESTRO SITO WEB