

SMALL LIVING KITCHENS™

CUCINE / KITCHENS

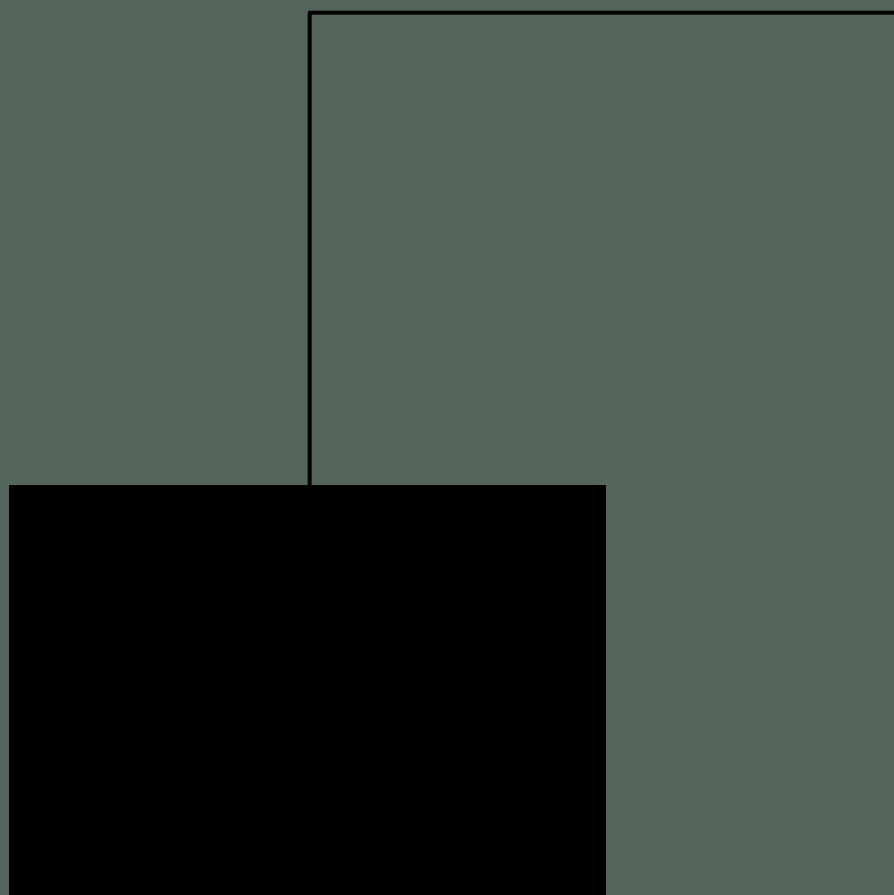

falper.

Small Living Kitchens™

introduzione / introduction	p. 04 – 21
madie + isole / storage units + islands	p. 22 – 57
colonne + isole / tall units + islands	p. 58 – 99
isole / islands	p. 102 – 121
madie / storage units	p. 122 – 139
colonne / tall units	p. 140 – 153
accessori / accessories	p. 154 – 159
sommario / summary	p. 160 – 161

FORME DISTINTIVE

Falper è un'azienda italiana specializzata nella produzione di elementi di arredo bagno di qualità superiore. Fondata nel 1962, nel corso degli anni l'azienda ha saputo evolvere la sua produzione raggiungendo un livello di eccellenza e una cifra stilistica identitaria, apprezzata e riconosciuta in Italia e nel mondo. A partire dal 2022, forte delle capacità tecniche nei sistemi, negli impianti e nella lavorazione di materiali idrofughi, Falper presenta Small Living Kitchens™ un concept di cucina inedito, razionale, conviviale e lussuoso che vanta ben tre brevetti. La nuova linea di cucine, progettata a quattro mani con il designer Andrea Federici, fa proprio

il design, il know-how, i materiali preziosi e le finiture eccellenti, l'artigianalità Made in Italy e l'attenzione sartoriale per i dettagli caratteristici di Falper. Accanto ai macchinari e alle tecnologie più all'avanguardia – per la lavorazione in nesting, la fresatura, la foratura e la bordatura – la produzione adotta un approccio completamente artigianale. Incollaggi, assemblaggi e montaggio sono interamente eseguiti a mano e ogni prodotto è sottoposto ad un severissimo controllo dagli esperti del reparto qualità. Inoltre, l'azienda adotta un approccio sostenibile: ogni pannello è certificato come ecologico, tutte le finiture legno sono all'acqua e gli scarti di lavorazione sono interamente riciclati.





DISTINCTIVE SHAPES

Falper is an Italian company that specializes in the production of superior-quality bathroom furnishings. Founded in 1962, the company has developed its products over the years, achieving a high level of excellence and distinctive style that is appreciated and recognized in Italy and around the world. Starting in 2022, drawing on its technical expertise in systems, equipment and processing of water-repellent materials, Falper presents Small Living Kitchens™, a new kitchen concept that's rational, convivial and luxurious, and boasts three patents. The new line of kitchens, developed in collaboration with designer Andrea Federici, fully embraces Falper's

characteristic design, expertise, high-quality materials, excellent finishes, Made in Italy craftsmanship and tailored details. In addition to the most advanced machinery and technologies – for nesting, milling, drilling and edging - the manufacturing process adopts a completely artisan approach. Gluing, assembling and mounting are entirely performed by hand and each product undergoes a very strict inspection by the experts of the quality department. Moreover, the company takes a sustainable approach: each panel is certified as environmentally friendly, all the wood finishes are water-based and processing waste is entirely recycled.

CRAFT

I mobili Falper hanno origine dalle mani di esperti artigiani che realizzano con estrema cura ogni singolo dettaglio, utilizzando impianti all'avanguardia per la lavorazione in nesting, la fresatura, la foratura e la bordatura. Lavorazioni a 45°, personalizzazioni, incollaggi poliuretanici resistenti all'acqua e materiali straordinari, come il multistrato di betulla ad incollaggio marino, il massello di rovere e i legni speciali fanno parte della quotidiana straordinarietà del reparto di falegnameria.

Falper's furniture is created by expert craftsmen who carefully manufacture every single detail, using state-of-the-art equipment for nesting, milling, drilling and edging. 45° machining, customization, water-resistant polyurethane gluing, and special materials such as marine-glued birch plywood, solid oak, and special wood varieties are all part of the extraordinary work carried out daily in the woodworking department.





STEEL

Le nuove Small Living Kitchens™ sono realizzate in acciaio AISI 304, un acciaio inossidabile particolarmente pregiato. Con uno spessore di soli 4mm, l'acciaio viene lavorato con saldature in continuità rendendo invisibili i giunti che uniscono piano e fianchi. Le parti diventano una sorta di monolite, un elemento unico al cui interno prende vita la cucina. Lavorazioni eccellenti, tecnologie innovative e un profondo know-how consentono di montare direttamente sul piano lavabi in acciaio, fuochi saldati, piani cottura a filo o in appoggio. L'acciaio può essere utilizzato anche su ante e frontali.

The new Small Living Kitchens™ are made of AISI 304 steel, an especially fine stainless steel. With a thickness of just 4 mm, the steel is seamlessly welded, making the joints between the top and sides invisible. The parts become a kind of monolith, a single element that brings the kitchen to life. Excellent craftsmanship, innovative technologies and in-depth expertise make it possible to install steel sinks and burners welded, flush-mounted or free-standing cooktops directly onto the top. Steel can also be used on doors and front panels.

MARBLE

Falper ha selezionato i marmi di cava più preziosi: classici eterni, come il Carrara, il Calacatta e il Nero Marquinia accanto a superfici più decise e caratterizzanti, come il Rosso Levanto e l'Arabescato Corchia. I marmi vengono lavorati con cura e precisione per dar vita ad oggetti scultorei, dalla bellezza senza tempo. Nella realizzazione delle Isole, il marmo viene alleggerito con inserti interni in honeycomb e bordato a 45° mantenendo nei giunti la continuità delle venature del marmo. Piano, fianchi, ante e frontali prendono così la forma di un monoblocco, un monolite al cui interno prende vita la cucina.

Falper has selected the finest quarry marbles: timeless classics such as Carrara, Calacatta and Nero Marquinia alongside bolder, more distinctive surfaces such as Levanto Red and Arabescato Corchia. The marbles are processed with care and precision to create sculptural objects of timeless beauty. To create the Islands, the marble is lightened with internal honeycomb inserts and edged at 45°, creating seamless marble veining in the joints. The top, sides, doors and front panels therefore form a single block, a monolith that brings the kitchen to life.



SMALL IS THE NEW LUXURY

Falper presenta Small Living Kitchens™, un concept inedito per rispondere alle esigenze di un abitare contemporaneo. Cucine da sogno pensate per soluzioni abitative di prestigio di piccole dimensioni. Convivialità, design, alti standard tecnologici, materiali, finiture ricercate e una qualità senza compromessi: Small Living Kitchens™ propone tutte le caratteristiche delle grandi cucine di lusso su configurazioni da 2,5mq, dando vita ad oggetti da esibire in continuità con una zona living ricercata. Isole, Madie e Colonne si compongono creando una luxury kitchen experience completa, su metrature incredibilmente ridotte.

Falper presents Small Living Kitchens™, a completely new concept to meet the needs of contemporary living. Dream kitchens designed for prestigious and small-sized housing solutions. Conviviality, design, high technological standards, materials, refined finishes and uncompromising quality: Small Living Kitchens™ offers all the features of large luxury kitchens on configurations starting from 2.5sqm, giving life to objects to be exhibited in a refined living area. Islands, Storage Units and Tall Units come together to create a complete luxury kitchen experience, on incredibly small sizes.





SMALL IS THE NEW CONVIVIALITY

Elementi progettati per parlare il linguaggio della zona living: ricercato, conviviale, prestigioso. Nelle Small Living Kitchens™, materiali, lavorazioni, finiture e dettagli costruttivi sono stati pensati per uscire dall'immaginario della cucina, andando ad appropriarsi non solo dello spazio ma anche del codice stilistico del living. Oggetti di design, realizzati con cura artigianale, racchiudono su metrature ridotte le funzionalità delle grandi cucine di lusso, portandole nell'ambiente domestico più rappresentativo del nostro abitare.

Elements designed to speak the language of living rooms: sophisticated, convivial, prestigious. In Small Living Kitchens™, materials, finishes and carefully-crafted details are conceived to transcend typical kitchen imagery, appropriating not only the space, but also the stylistic aspects of the living room. Design objects made with artisanal skill contain all the functionality of a large luxury kitchen in a compact space, bringing it into the domestic space that best represents our home lifestyle.

SMALL IS THE ULTIMATE SIMPLICITY

Brevettato / Patented

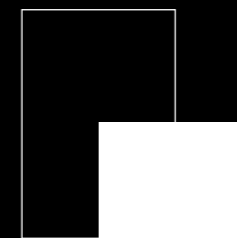

da / from 2.5 SQ.M



a / to 7.5 SQ.M

Un sistema compositivo brevettato, razionale e semplice nella progettazione, composto da pochi elementi - Isole, Madie e Colonne - capaci di dare vita ad infinite composizioni a partire da 2,5mq. Le Isole si declinano in tre modelli, disponibili in tre diverse dimensioni. La Madia è un elemento unico, finito su tutti i lati, configurabile internamente in molteplici varianti. Le Colonne, invece, sono elementi componibili, combinabili tra loro per creare una vera e propria parete attrezzata, e configurabili internamente in molteplici varianti.

A patented, rational and simple design modular system, made up of few elements - Islands, Storage Units and Tall Units - capable of giving rise to infinite compositions starting from 2.5sqm. The Islands come in three models, available in three different sizes. The Storage Unit is a single element, finished on all sides, internally configurable in multiple variations. The Tall Units, on the other hand, are modular elements, which can be combined together to create a real equipped wall, and can be internally configured in multiple variations.

ISOLE + MADIE /
ISLANDS + STORAGE UNITS

Isole /
Islands



120 cm

150 cm

180 cm

Madie /
Storage Units

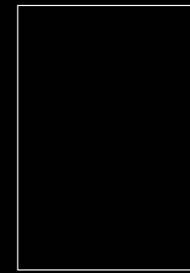

122 cm

Composizioni /
Compositions

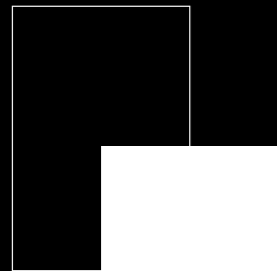

2.5 SQ.M

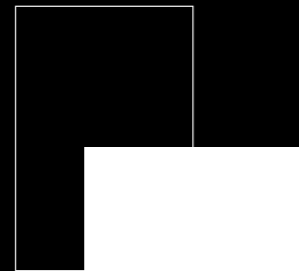

4 SQ.M

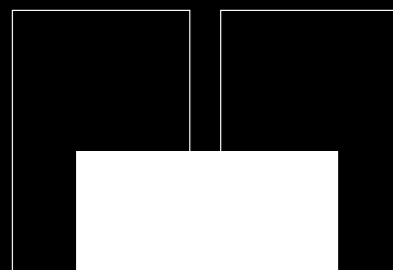

5.5 SQ.M

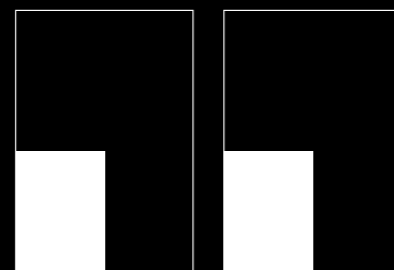

7 SQ.M

ISOLE + COLONNE /
ISLANDS + TALL UNITS

Isole /
Islands



120 cm

150 cm

180 cm

Colonne /
Tall Units

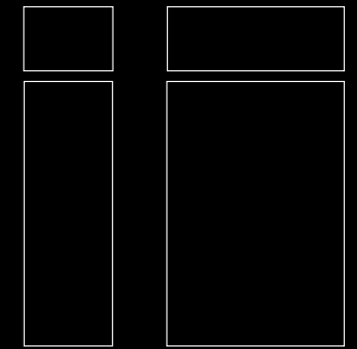

64 cm

120 cm

Composizioni /
Compositions

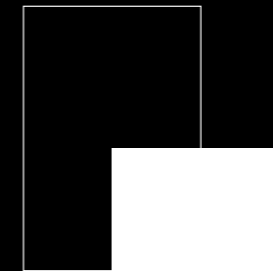

2.5 SQ.M

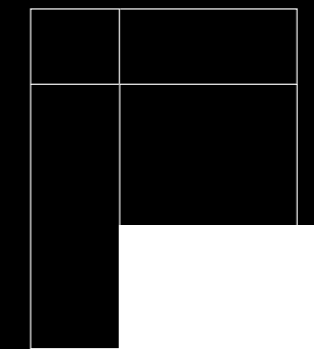

3 SQ.M

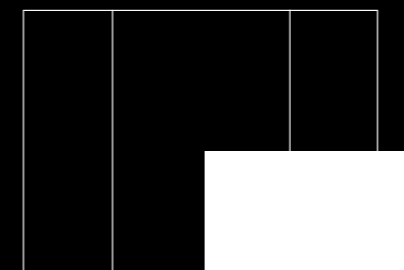

7 SQ.M

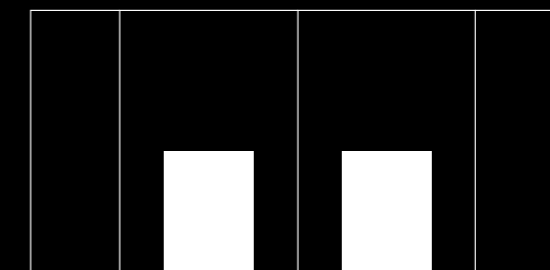

10 SQ.M

ISOLE + MADIE ISLANDS + STORAGE UNITS

DESIGN ANDREA FEDERICI

Nelle composizioni che accostano Isole e Madie, le Small Living Kitchens™ firmate Falper propongono una cucina completa a partire da soli 2,5mq. La convivialità, l'emozionalità, il design e le funzioni di una grande cucina di lusso scoprono una dimensione del tutto inedita, aprendo le porte ad una estrema componibilità e personalizzazione grazie a dimensioni, varianti, materiali e finiture differenti. La Madia, perfettamente rifinita su tutti i lati, si configura come un vero e proprio elemento di arredo, posizionabile sia a parete che all'interno di nicchie o a semi incasso. Disponibile in undici diverse configurazioni, la Madia è stata brevettata nel design e nel sistema di apertura a 45°: un oggetto ricercato ed elegante, essenziale per realizzare un raffinato spazio cucina o un living di design.

In the compositions that combine Islands and Storage Units, the Small Living Kitchens™ by Falper offer a complete kitchen starting from just 2.5sqm. The conviviality, emotionality, design and functions of a large luxury kitchen discover a completely new dimension, opening the doors to extreme modularity and customization thanks to different sizes, variants, materials and finishes. The Storage Unit, perfectly finished on all sides, is configured as a real piece of furniture, which can be positioned both on the wall and niches or semirecessed. Available in eleven different configurations, the Storage Unit has a patented design and 45°-opening system: sophisticated and elegant, it's an essential element for a refined designer kitchen or living space.

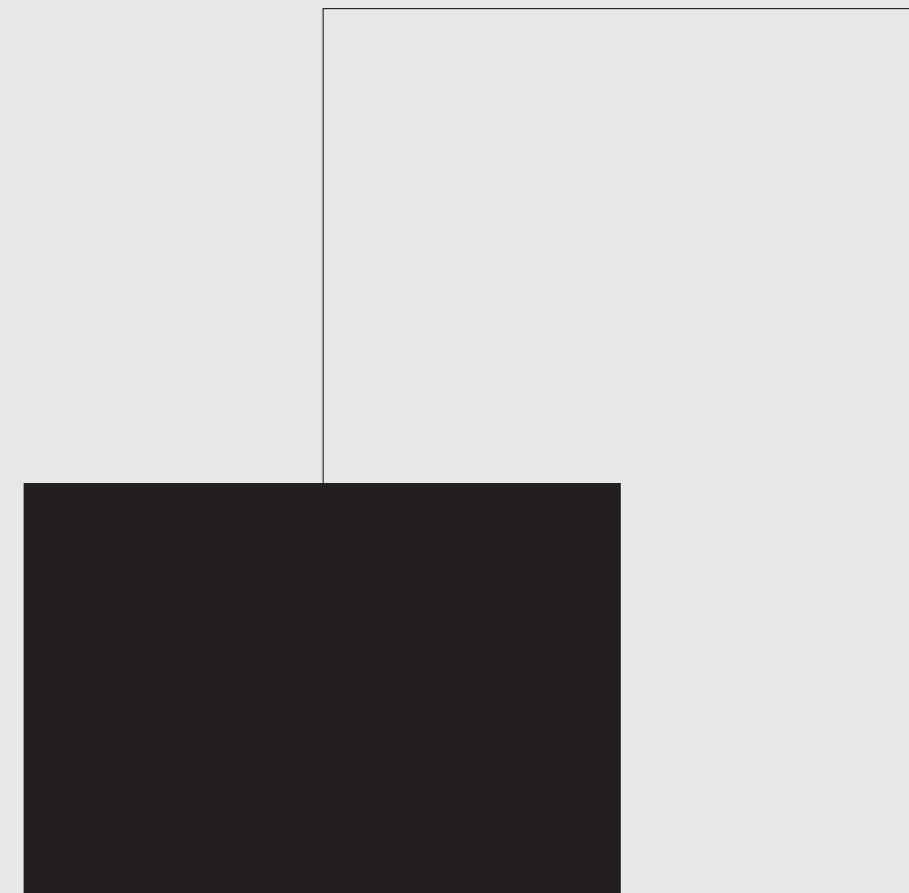

INSPIRATIONS #01

ISOLA / ISLAND MODEL 2
MADIE / STORAGE UNITS 02 - 07

6 SQ.M

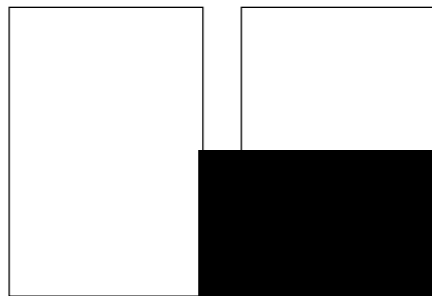



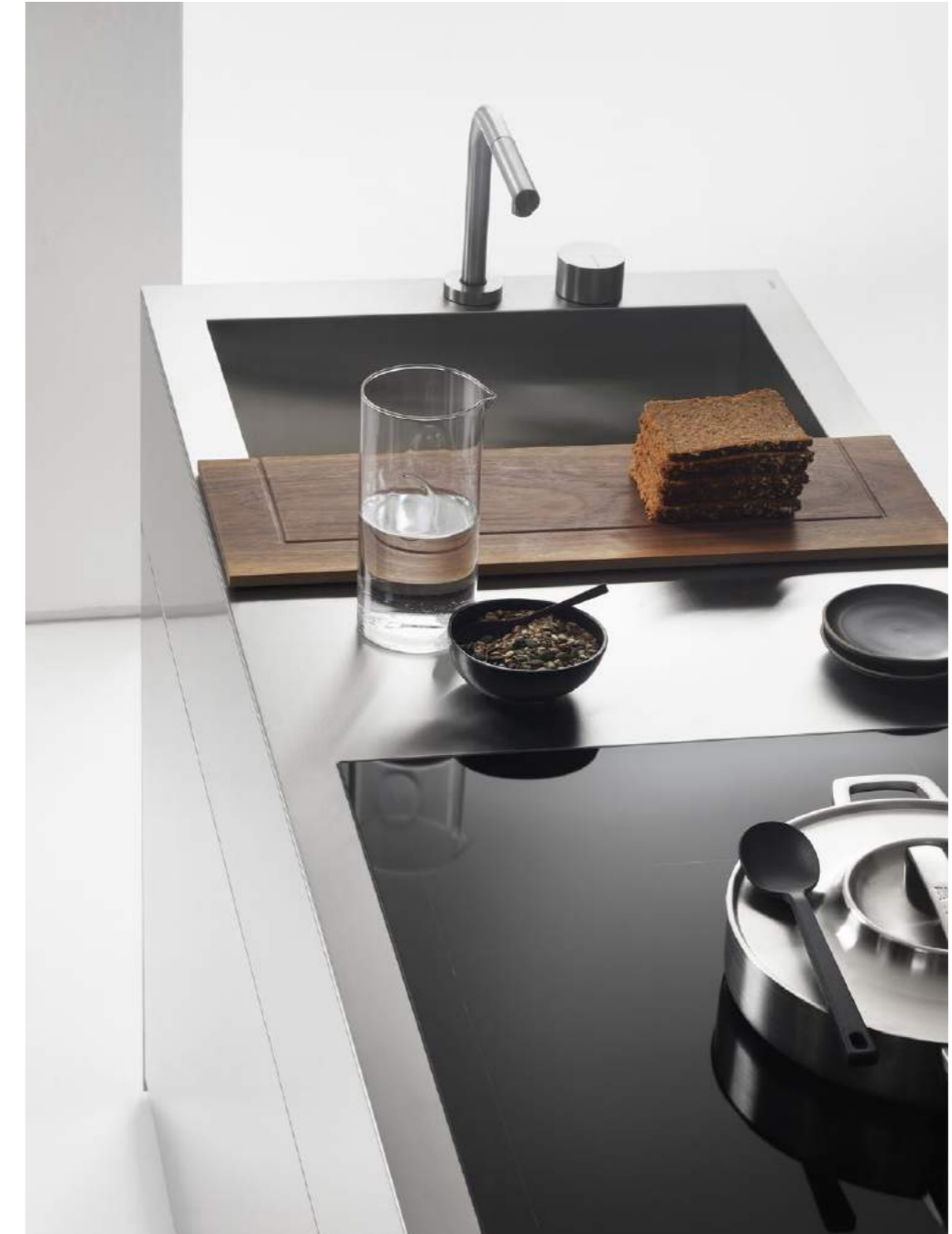



Isola Model 2 con top e fianchi in acciaio inox con spessore 4mm, disponibile con larghezza 120cm, 150cm e 180cm. I cassetti in noce massello, serie Blum Legrabox con stabilizzatori e soft close integrati, sono completamente estraibili e possono essere completati e impreziositi con gli accessori, pensati da Falper per organizzare al meglio gli spazi.

Island Model 2 with 4mm thick stainless steel top and sides, available in 120cm, 150cm and 180cm widths. The solid walnut drawers from the Blum Legrabox series, featuring built-in stabilizers and soft-close elements, are fully removable and can be completed and enhanced with accessories designed by Falper for optimal space organization.

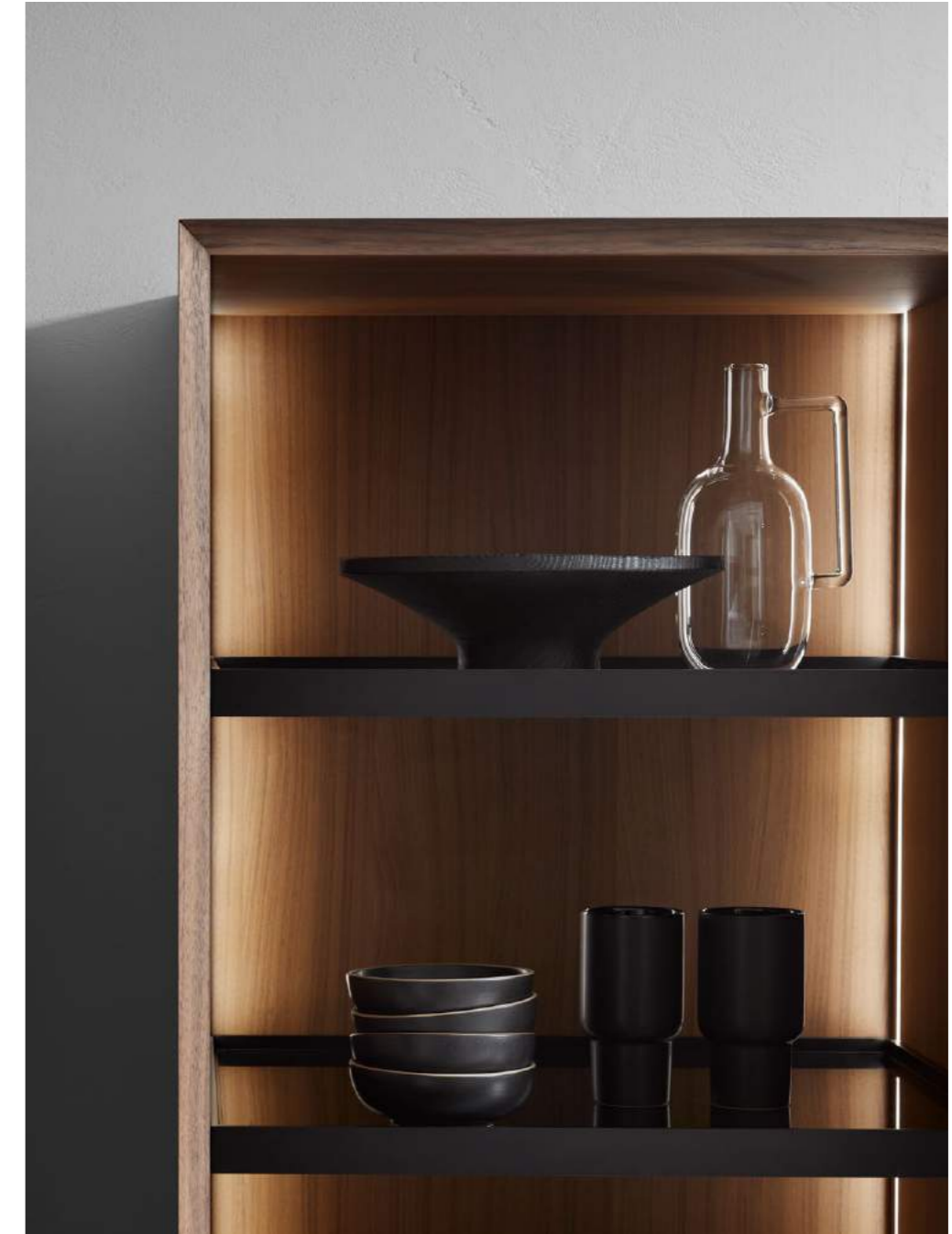



Isola Model 2 con top e fianchi in acciaio inox con spessore 4mm, disponibile con larghezza 120cm, 150cm e 180cm. Frontali realizzabili nelle finiture legno, nelle laccature lucide e opache a catalogo e in finitura inox nelle varianti a catalogo. Disponibile nelle versioni con piano cottura e lavello, solo piano cottura o solo lavello. Il top può essere predisposto per piano cottura a gas o a induzione. I cassetti in noce massello, serie Blum Legrabox con stabilizzatori e soft close integrati, sono completamente estraibili. Madia 2 con predisposizione dispensa, vano a giorno con mensole in vetro e alluminio. Possibilità di configurazione destra o sinistra. Madia 4B con vano a giorno con mensola in vetro e alluminio, predisposizione forno h 45cm e predisposizione lavastoviglie. Anta con predisposizione frigorifero da incasso con cerniera portante. Possibilità di configurazione destra o sinistra.

Island Model 2 with 4mm thick stainless steel top and sides, available in 120cm, 150cm and 180cm widths. Fronts available in wood finishes, in glossy and matt lacquers and in stainless steel finishes in the catalog. Available in versions with a hob and sink, hob only or sink only. The top can be fitted for gas or induction hobs. The solid walnut drawers with Blum Legrabox runners, integrated stabilizers and soft close can be completely removed. Storage Unit 2 with layout for a pantry, open compartment and glass and aluminium shelves. Option of left or right configuration. Storage Unit 4B with open compartment with a glass and aluminium shelf, h 45cm oven set-up and dishwasher set-up. Door with built-in refrigerator with load-bearing hinge. Option of left or right configuration.

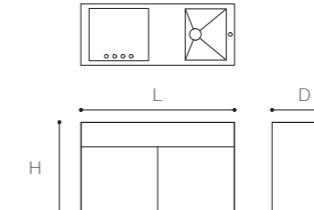
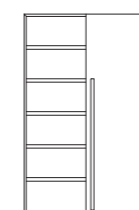
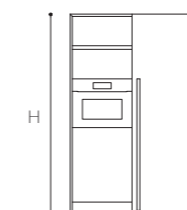
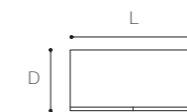

Isola / Island
(L) 120 - 150 - 180 cm
(H) 91 cm
(D) 60 cm
Colori disponibili / Available colors
p. 114 - 115

Madie / Storage Units
(L) 122 cm
(H) 202 cm
(D) 61 cm
Colori disponibili / Available colors
p. 138 - 139

INSPIRATIONS #02

ISOLA / ISLAND MODEL 2
MADIE / STORAGE UNITS 07

2.5 SQ.M

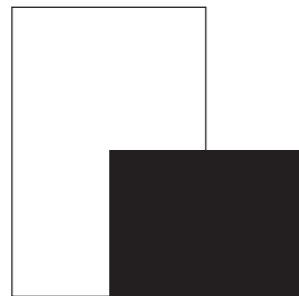



Isola Model 2 con top e fianchi in acciaio inox con spessore 4mm, disponibile con larghezza 120cm, 150cm e 180cm. Frontali realizzabili nelle finiture legno e nelle laccature lucide e opache a catalogo e in finitura inox nelle varianti a catalogo. Disponibile nelle versioni con piano cottura e lavello, solo piano cottura o solo lavello. Il top può essere predisposto per piano cottura a gas o a induzione. I cassetti in noce massello, serie Blum Legrabox con stabilizzatori e soft close integrati, sono completamente estraibili. Madia 4B con vano a giorno con mensola in vetro e alluminio, predisposizione forno h 45cm e predisposizione lavastoviglie. Anta con predisposizione frigorifero da incasso con cerniera portante. Possibilità di configurazione destra o sinistra.

Island Model 2 with 4mm thick stainless steel top and sides, available in 120cm, 150cm and 180cm widths. Fronts available in wood finishes and in glossy and matt lacquers and in stainless steel finishes in the catalog. Available in versions with a hob and sink, hob only or sink only. The top can be fitted for gas or induction hobs. The solid walnut drawers with Blum Legrabox runners, integrated stabilizers and soft close can be completely removed. Storage Unit 4B with open compartment with a glass and aluminium shelf, h 45cm oven set-up and dishwasher set-up. Door with built-in refrigerator with load-bearing hinge. Option of left or right configuration.

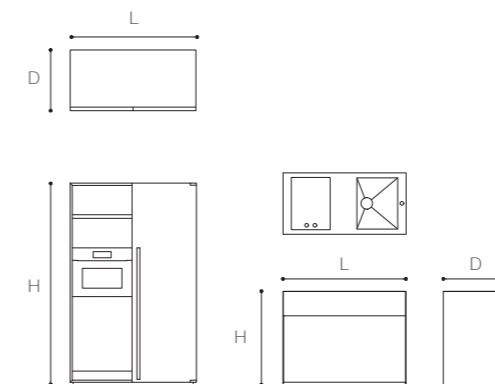

Isola / Island
 (L) 120 - 150 - 180 cm
 (H) 91 cm
 (D) 60 cm
 Colori disponibili / Available colors
 p. 114 - 115

Madia / Storage Unit
 (L) 122 cm
 (H) 202 cm
 (D) 61 cm
 Colori disponibili / Available colors
 p. 138 - 139

INSPIRATIONS #03

ISOLA / ISLAND MODEL 3
MADIE / STORAGE UNITS 06 - 09

7 SQ.M

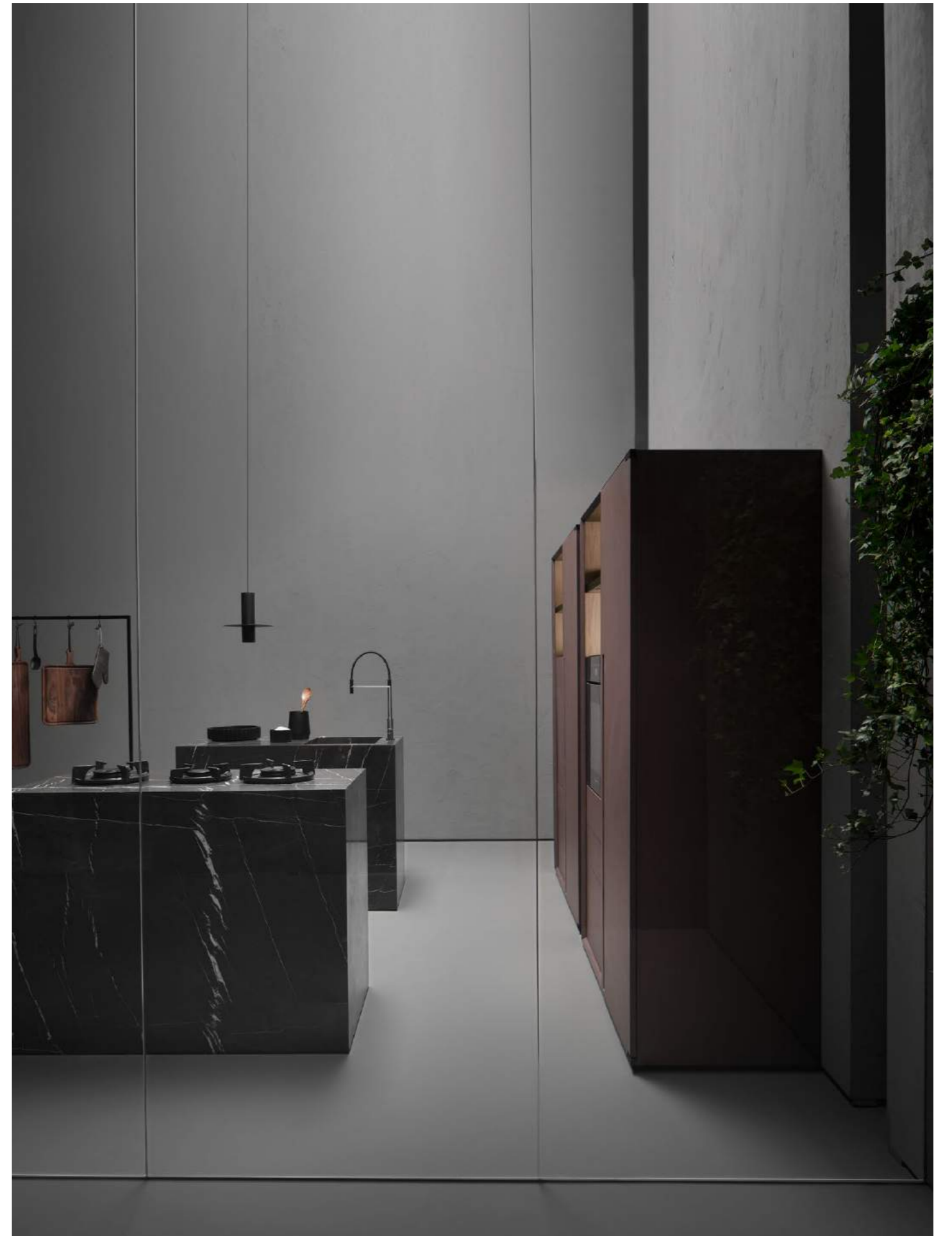
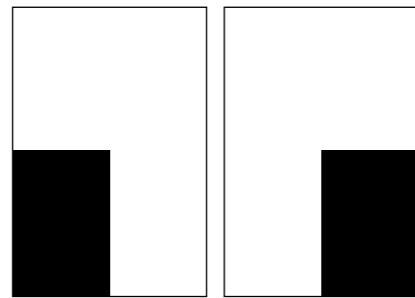









Isola Model 3 interamente realizzata in marmo, alleggerito con inserti interni in honeycomb, realizzabile nei marmi a catalogo. Disponibile con larghezza 120cm, 150cm e 180cm. Disponibile nelle versioni con piano cottura e lavello, solo piano cottura o solo lavello. Il top può essere predisposto per piano cottura a gas o a induzione. I cassetti in noce massello, serie Blum Legrabox con stabilizzatori e soft close integrati, sono completamente estraibili. Madia 6 con vano a giorno con mensola in vetro e alluminio, predisposizione per lavastoviglie e un cassetto. Anta con predisposizione dispensa. Possibilità di configurazione destra o sinistra. Madia 3B con vano a giorno con mensola in vetro e alluminio, predisposizione per forno da incasso h 60cm e due cassetti. Anta con predisposizione per frigorifero da incasso con cerniera portante. Possibilità di configurazione destra o sinistra.

Island Model 3 entirely made of marble, lightened with internal honeycomb inserts, available in the marbles in the catalog. Available in 120cm, 150cm and 180cm widths. Available in versions with a hob and sink, hob only or sink only. The top can be fitted for gas or induction hobs. The drawers in solid walnut with Blum Legrabox guides with integrated stabilizers and soft close, are completely removable.

Storage Unit 6 with open compartment with a glass and aluminium shelf, dishwasher set-up and one drawer. Door with pantry set-up. Option of left or right configuration. Storage Unit 3B with open compartment with a glass and aluminium shelf, set-up for a h 60cm built-in oven and two drawers. Door with built-in refrigerator with load-bearing hinge. Option of left or right configuration.



Isola / Island
 (L) 120 - 150 - 180 cm
 (H) 91 cm
 (D) 60 cm
 Colori disponibili / Available colors
 p. 120 - 121

Madie / Storage Units
 (L) 122 cm
 (H) 202 cm
 (D) 61 cm
 Colori disponibili / Available colors
 p. 138 - 139

INSPIRATIONS #04

ISOLA / ISLAND MODEL 2
MADIE / STORAGE UNITS 07

4 SQ.M

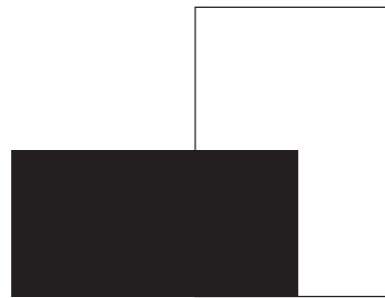





Isola Model 2 con top e fianchi in acciaio inox con spessore 4mm, disponibile con larghezza 120cm, 150cm e 180cm. Frontali realizzabili nelle finiture legno e nelle laccature lucide e opache a catalogo e in finitura inox nelle varianti a catalogo. Disponibile nelle versioni con piano cottura e lavello, solo piano cottura o solo lavello. Il top può essere predisposto per piano cottura a gas o a induzione. I cassetti in noce massello, serie Blum Legrabox con stabilizzatori e soft close integrati, sono completamente estraibili. Madia 4B con vano a giorno con mensola in vetro e alluminio, predisposizione forno h 45cm e predisposizione lavastoviglie. Anta con predisposizione frigorifero da incasso con cerniera portante. Possibilità di configurazione destra o sinistra.

Island Model 2 with 4mm thick stainless steel top and sides, available in 120cm, 150cm and 180cm widths. Fronts available in wood finishes and in glossy and matt lacquers and in stainless steel finishes in the catalog. Available in versions with a hob and sink, hob only or sink only. The top can be fitted for gas or induction hobs. The solid walnut drawers with Blum Legrabox runners, integrated stabilizers and soft close can be completely removed. Storage Unit 4B with open compartment with a glass and aluminium shelf, h 45cm oven set-up and dishwasher set-up. Door with built-in refrigerator with load-bearing hinge. Option of left or right configuration.

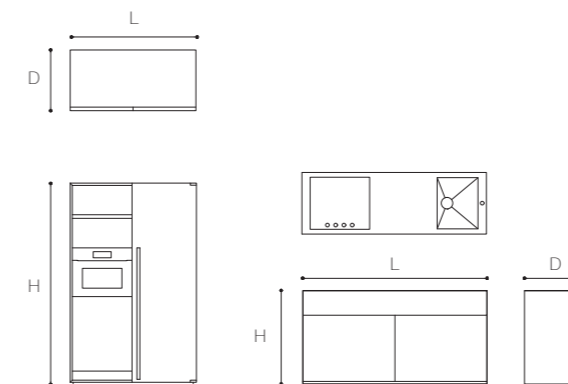

Isola / Island
 (L) 120 - 150 - 180 cm
 (H) 91 cm
 (D) 60 cm
 Colori disponibili / Available colors
 p. 114 - 115

Madia / Storage Unit
 (L) 122 cm
 (H) 202 cm
 (D) 61 cm
 Colori disponibili / Available colors
 p. 138 - 139

ISOLE + COLONNE ISLANDS + TALL UNITS

DESIGN ANDREA FEDERICI

Nelle composizioni che accostano Isole e Colonne, le Small Living Kitchens™ firmate Falper propongono una cucina completa con possibilità di creare una vera e propria parete attrezzata, a partire da soli 2,5mq. Le Isole si declinano in tre modelli, disponibili in diverse dimensioni e caratterizzati da dettagli, finiture e materiali differenti. Le Colonne sono elementi componibili, combinabili tra loro e configurabili internamente in molteplici modelli funzionali. Sono costituite da elementi con larghezza da 60/64cm o da 120cm e possono essere completate da Sopra-Colonne realizzabili su misura in altezza.

In compositions with Islands and Tall Units, Falper Small Living Kitchens™ are complete kitchens that offer the possibility of creating ingenious wall units in spaces as small as 2.5 sq. m. Islands come in three models and various sizes, and can feature a range of different details, finishes and materials. Tall Units are modular elements, combinable and internally configurable in numerous functional ways. In 60/64cm or 120cm widths, they can be enhanced with customisable-height top compartments.



INSPIRATIONS #05

ISOLA / ISLAND MODEL 1
COLONNE / TALL UNITS A + 60

6 SQ.M

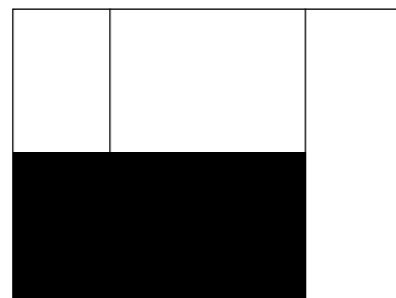



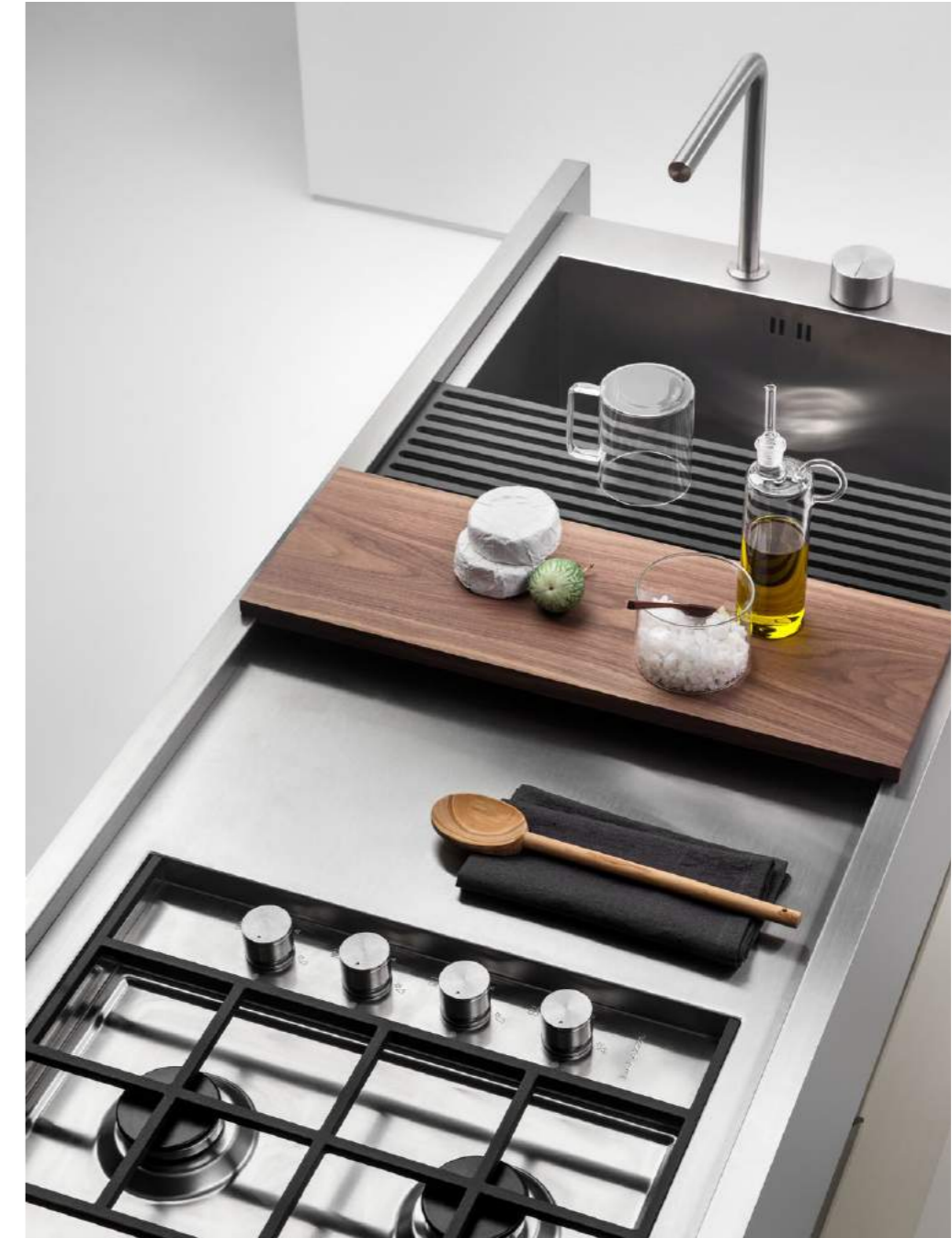





Isola Model 1 con top e fianchi in acciaio inox con spessore 4mm, disponibile con larghezza 150cm e 180cm. Frontali con laterali sporgenti, realizzabili nelle finiture legno e nelle laccature lucide e opache a catalogo. Disponibile nelle versioni con piano cottura e lavello, solo piano cottura o solo lavello. Il top può essere predisposto per piano cottura a gas o a induzione. I cassetti in noce massello, serie Blum Legrabox con stabilizzatori e soft close integrati, sono completamente estraibili. Colonna A con doppia anta a scomparsa, configurazione con cassettoni, mensole a giorno e predisposizione per forno. Colonna con anta singola con anta a scomparsa, configurazione con predisposizione per frigorifero o dispensa. Disponibile con apertura sul lato destro o sinistro del mobile. Sopra-Colonna in legno con profondità 70cm, disponibili in versione singola o doppia. Altezza su misura da 40cm a 100cm.

Island Model 1 with 4mm thick stainless steel top and sides, available in 150cm and 180cm widths. Fronts with protruding sides, available in the wood finishes and in the glossy and matt lacquers in the catalog. Available in versions with a hob and sink, hob only or sink only. The top can be fitted for gas or induction hobs. The solid walnut drawers with Blum Legrabox runners, integrated stabilizers and soft close can be completely removed. Tall Unit A with retractable double doors, layout with drawers, open shelves and space for an oven. Tall Unit with single, retractable door, layout for refrigerator or pantry. Available with opening on the right or left side of the Storage Unit. Tall Unit top compartment in wood with a depth of 70cm depth, available in single or double versions. Customizable height from 40cm to 100cm.

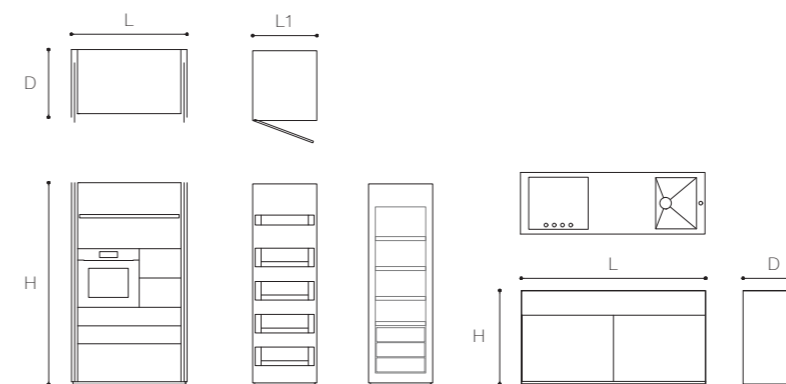

Isola / Island
 (L) 150 - 180 cm
 (H) 93 cm
 (D) 60 cm
 Colori disponibili / Available colors
 p. 108 - 109

Colonne / Tall Units
 (L) 120 cm
 (L1) 60 - 64 cm
 (H) 202 cm
 (D) 70 cm
 Colori disponibili / Available colors
 p. 152 - 153

INSPIRATIONS #06

ISOLA / ISLAND MODEL 2
COLONNE / TALL UNITS A + 60

6 SQ.M

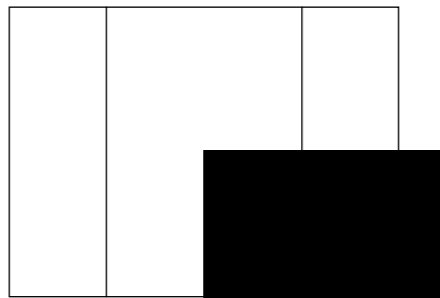









Isola Model 2 con top e fianchi in acciaio inox con spessore 4mm, disponibile con larghezza 120cm, 150cm e 180cm. Frontali realizzabili nelle finiture legno e nelle laccature lucide e opache a catalogo e in finitura inox nelle varianti a catalogo. Disponibile nelle versioni con piano cottura e lavello, solo piano cottura o solo lavello. Il top può essere predisposto per piano cottura a gas o a induzione. I cassetti in noce massello, serie Blum Legrabox con stabilizzatori e soft close integrati, sono completamente estraibili. Colonna A con doppia anta a scomparsa, configurazione con cassettoni, mensole a giorno e predisposizione per forno. Colonna Anta Singola, configurazione con predisposizione per frigorifero o dispensa. Disponibile con apertura sul lato destro o sinistro del mobile. Sopra-Colonna in legno con profondità 70cm, disponibili in versione singola o doppia. Altezza su misura da 40cm a 100cm.

Island Model 2 with 4mm thick stainless steel top and sides, available in 120cm, 150cm and 180cm width. Front panels available in the wood finishes and in the glossy and matt lacquers in the catalog and in a stainless steel finish in the variants listed in the catalog. Available in versions with a hob and sink, hob only or sink only. The top can be fitted for gas or induction hobs. The solid walnut drawers with Blum Legrabox runners, integrated stabilizers and soft close can be completely removed. Tall Unit A with double retractable doors, layout with drawers, open shelves and space for an oven. Single Tall Unit, layout for refrigerator or pantry. Available with opening on the right or left side of the unit. Tall Unit top compartment in wood with a depth of 70cm, available in single or double versions. Customizable height from 40cm to 100cm.

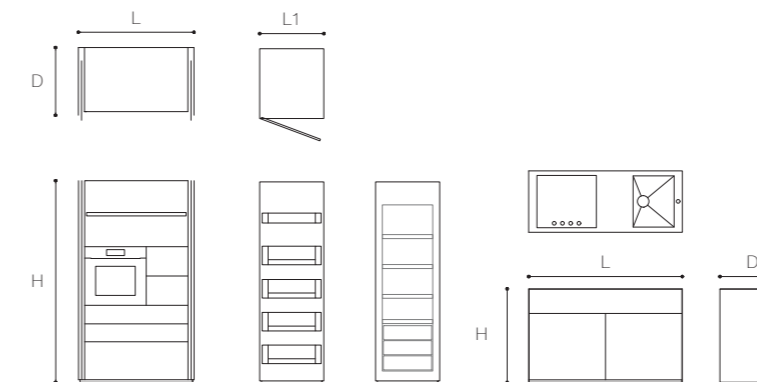

Isola / Island
 (L) 120 - 150 - 180 cm
 (H) 91 cm
 (D) 60 cm
 Colori disponibili / Available colors
 p. 114 - 115

Colonne / Tall Units
 (L) 120 cm
 (L1) 60 - 64 cm
 (H) 202 cm
 (D) 70 cm
 Colori disponibili / Available colors
 p. 152 - 153

INSPIRATIONS #07

ISOLA / ISLAND MODEL 2
COLONNE / TALL UNITS D1

2.5 SQ.M

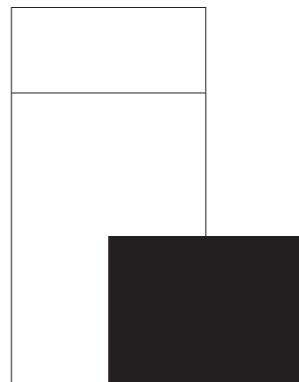



Isola Model 2 con top e fianchi in acciaio inox con spessore 4mm, disponibile con larghezza 120cm, 150cm e 180cm. Disponibile nelle versioni con piano cottura e lavello, solo piano cottura o solo lavello. Il top può essere predisposto per piano cottura a gas o a induzione.

Island Model 2 with 4mm thick stainless steel top and sides, available in 120cm, 150cm and 180cm width. Available in versions with a hob and sink, hob only or sink only. The top can be fitted for gas or induction hobs.



Isola Model 2 con top e fianchi in acciaio inox con spessore 4mm, disponibile con larghezza 120cm, 150cm e 180cm. Frontali realizzabili nelle finiture legno e nelle laccature lucide e opache a catalogo e in finitura inox nelle varianti a catalogo. Disponibile nelle versioni con piano cottura e lavello, solo piano cottura o solo lavello. Il top può essere predisposto per piano cottura a gas o a induzione. I cassetti in noce massello, serie Blum Legrabox con stabilizzatori e soft close integrati, sono completamente estraibili. Colonna D1 con doppia anta a scomparsa, configurazione con cassetto, mensole a giorno e predisposizione per lavastoviglie. Sopra-Colonna in legno con profondità 70cm, disponibili in versione singola o doppia. Altezza su misura da 40cm a 100cm.

Island Model 2 with 4mm thick stainless steel top and sides, available in 120cm, 150cm and 180cm width. Front panels available in the wood finishes and in the glossy and matt lacquers in the catalog and in a stainless steel finish in the variants listed in the catalog. Available in versions with a hob and sink, hob only or sink only. The top can be fitted for gas or induction hobs. The solid walnut drawers with Blum Legrabox runners, integrated stabilizers and soft close can be completely removed. Tall Unit D1 with double retractable doors, layout with drawer, open shelves and space for dishwasher. Tall Unit top compartment in wood with a depth of 70cm, available in single or double versions. Customizable height from 40cm to 100cm.

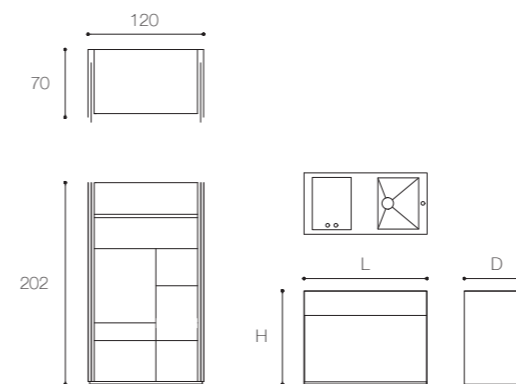

Isola / Island
 (L) 120 - 150 - 180 cm
 (H) 91 cm
 (D) 60 cm
 Colori disponibili / Available colors
 p. 114 - 115

Colonna / Tall Unit
 (L) 120 cm
 (H) 202 cm
 (D) 70 cm
 Colori disponibili / Available colors
 p. 152 - 153

INSPIRATIONS #08

ISOLA / ISLAND MODEL 2
COLONNE / TALL UNITS B + 60

3 SQ.M

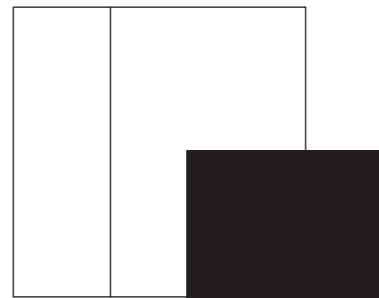



Isola Model 2 con top e fianchi in acciaio inox con spessore 4mm, disponibile con larghezza 120cm, 150cm e 180cm. Disponibile nelle versioni con piano cottura e lavello, solo piano cottura o solo lavello. Il top può essere predisposto per piano cottura a gas o a induzione.

Island Model 2 with 4mm thick stainless steel top and sides, available in 120cm, 150cm and 180cm width. Available in versions with a hob and sink, hob only or sink only. The top can be fitted for gas or induction hobs.



Isola Model 2 con top e fianchi in acciaio inox con spessore 4mm, disponibile con larghezza 120cm, 150cm e 180cm. Frontali realizzabili nelle finiture legno e nelle laccature lucide e opache a catalogo e in finitura inox nelle varianti a catalogo. Disponibile nelle versioni con piano cottura e lavello, solo piano cottura o solo lavello. Il top può essere predisposto per piano cottura a gas o a induzione. I cassetti in noce massello, serie Blum Legrabox con stabilizzatori e soft close integrati, sono completamente estraibili. Colonna B con doppia anta a scomparsa, configurazione con mensole a giorno, predisposizione per forno h 45cm, predisposizione per lavastoviglie e tre cassetti.

Island Model 2 with 4mm thick stainless steel top and sides, available in 120cm, 150cm and 180cm width. Front panels available in the wood finishes and in the glossy and matt lacquers in the catalog and in a stainless steel finish in the variants listed in the catalog. Available in versions with a hob and sink, hob only or sink only. The top can be fitted for gas or induction hobs. The solid walnut drawers with Blum Legrabox runners, integrated stabilizers and soft close can be completely removed. Tall Unit B with double retractable door, configuration with open shelves, h 45cm oven set-up, dishwasher set-up and three drawers.

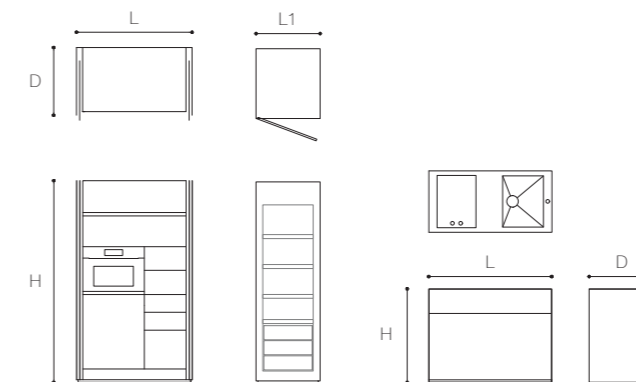

Isola / Island
 (L) 120 - 150 - 180 cm
 (H) 91 cm
 (D) 60 cm
 Colori disponibili / Available colors
 p. 114 - 115

Colonne / Tall Units
 (L) 120 cm
 (L1) 60 - 64 cm
 (H) 202 cm
 (D) 70 cm
 Colori disponibili / Available colors
 p. 152 - 153

INSPIRATIONS #09

ISOLA / ISLAND MODEL 3
COLONNE / TALL UNITS B1 + F + 60

10 SQ.M

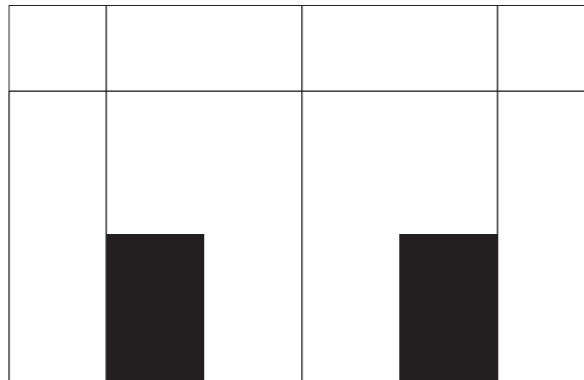







Isola Model 3 interamente realizzata in marmo, alleggerito con inserti interni in honeycomb, realizzabile nei marmi a catalogo. Disponibile con larghezza 120cm, 150cm e 180cm. Disponibile nelle versioni con piano cottura e lavello, solo piano cottura o solo lavello. Il top può essere predisposto per piano cottura a gas o a induzione. I cassetti in noce massello, serie Blum Legrabox con stabilizzatori e soft close integrati, sono completamente estraibili. Colonna B1 con doppia anta a scomparsa, configurazione con mensole a giorno, predisposizione per forno h 45cm e predisposizione per lavastoviglie. Colonna F con doppia anta a scomparsa, configurazione con cassettoni e mensole a giorno.

Island Model 3 entirely made of marble, lightened with internal honeycomb inserts, available in the marbles in the catalog. Available in 120cm, 150cm and 180cm widths. Available in versions with a hob and sink, hob only or sink only. The top can be fitted for gas or induction hobs. The solid walnut drawers with Blum Legrabox runners, integrated stabilizers and soft close can be completely removed. Tall Unit B1 with double retractable door, configuration with open shelves, h 45cm oven set-up and dishwasher set-up. Tall Unit F with double retractable doors, layout with drawers and open shelves.

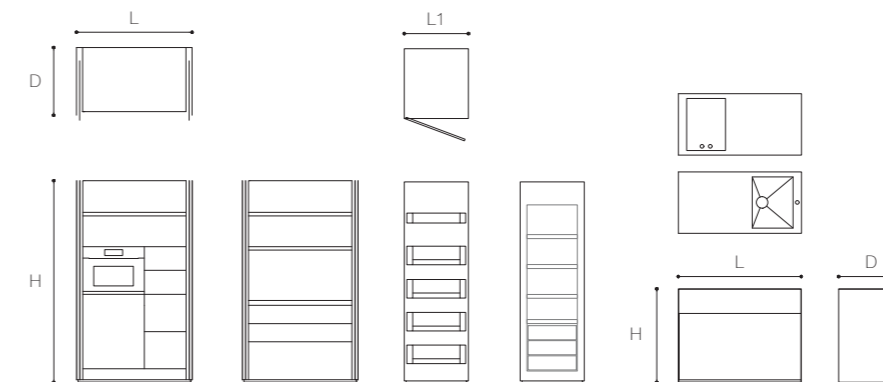

Isola / Island
 (L) 120 - 150 - 180 cm
 (H) 91 cm
 (D) 60 cm
 Colori disponibili / Available colors
 p. 120 - 121

Colonne / Tall Units
 (L) 120 cm
 (L1) 60 - 64 cm
 (H) 202 cm
 (D) 70 cm
 Colori disponibili / Available colors
 p. 152 - 153

SMALL LIVING KITCHENS™ ELEMENTS

Un sistema compositivo razionale e semplice nella progettazione, composto da pochi elementi - Isole, Madie e Colonne - capaci di dare vita ad infinite composizioni a partire da 2,5mq. Le Isole si declinano in tre modelli, disponibili in tre diverse dimensioni. La Madia è un elemento unico, finito su tutti i lati, configurabile internamente in molteplici varianti. Le Colonne, invece, sono elementi componibili, combinabili tra loro per creare una vera e propria parete attrezzata, e configurabili internamente in molteplici varianti.

A rational and simple design modular system, made up of few elements - Islands, Storage Units and Tall Units - capable of giving life to infinite compositions starting from 2,5sqm. The Islands come in three models, available in three different sizes. The Storage Unit is a single element, finished on all sides, internally configurable in multiple variations. The Tall Units, on the other hand, are modular elements, which can be combined together to create a real equipped wall, and can be internally configured in multiple variations.



Multistrato di betulla AW100, Idropan idrofuogo, MDF, massello di noce. / Birch plywood AW100, Idropan MDF and solid Oak.



Lavorazione a 45° / 45 degrees edge.



Incollaggi poliuretano. Verniciatura testata per ambienti umidi. / Polyurethane glue. Painting tested for humid ambients.



Laccatura manuale diretta. Colorazioni speciali su richiesta. / Direct manual varnishing. Special finishings on request.



Cassetti BLUM Legrabox di serie su tutte le collezioni. / BLUM Legrabox drawers as standard for all collections.



Stabilizzatori e sincronizzatori di serie oltre i 100 cm. / Drawer stabilizers as standard over 100 cm.



Attacchi a parete ad alta portata con sistema anti sganciamento. / Adjustable high capacity wall connections with scratch-proof safety system.



Riciclabile. / Recyclable.



5 anni di garanzia. / 5 years warranty.



Finiture all'acqua completamente prive di stirolo. / Styrol free water based finishings.



Colorazioni speciali su richiesta. / Special finishings on request.



Procedimento di verniciatura testato per ambienti umidi. / Painting procedure tested for humid ambients.



Controllo di qualità di ogni singolo mobile. / Quality control of every single furniture.

ISOLE ISLANDS



Le Isole si declinano in tre modelli, disponibili in diverse dimensioni e caratterizzati da dettagli, finiture e materiali differenti. I bordi sono a 45°, con lavorazioni di precisione che consentono, nella versione in marmo, la continuità della venatura tra piano e fianchi e, nelle versioni in acciaio, saldature in continuità, rendendo invisibili i giunti. Tutti i prodotti sono controllati e certificati singolarmente e le Isole sono coperte da una garanzia di 5 anni. I cassetti in noce massello, serie Blum Legrabox con stabilizzatori e soft close integrati, sono completamente estraibili.

The Islands come in three models, available in various sizes and featuring different details, finishes and materials. The edges have a 45° angle, featuring precise workmanship that ensures, in the marble version, seamless veining between the top and sides and, in the steel versions, seamless welding, making the joints invisible. All products are individually inspected and certified and the Islands are covered by a 5-year warranty. The solid walnut drawers from the Blum Legrabox series, featuring built-in stabilizers and soft-close elements, are fully removable.



MODEL 1
DESIGN ANDREA FEDERICI

Isola con top e fianchi in acciaio inox con spessore 4mm, disponibile con larghezza 150cm e 180cm. Frontali con laterali sporgenti, realizzabili nelle finiture legno e nelle laccature lucide e opache a catalogo. Disponibile nelle versioni con piano cottura e lavello, solo piano cottura o solo lavello. Il top può essere predisposto per piano cottura a gas o a induzione. I cassetti in noce massello, serie Blum Legrabox con stabilizzatori e soft close integrati, sono completamente estraibili.

Island with 4mm thick stainless steel top and sides, available in 150cm and 180cm widths. Fronts with protruding sides, available in the wood finishes and in the glossy and matt lacquers in the catalog. Available in versions with hob and sink, hob only or sink only. The hob is available in gas or induction versions. The drawers in solid walnut with Blum Legrabox guides with integrated stabilizers and soft close, are completely removable.

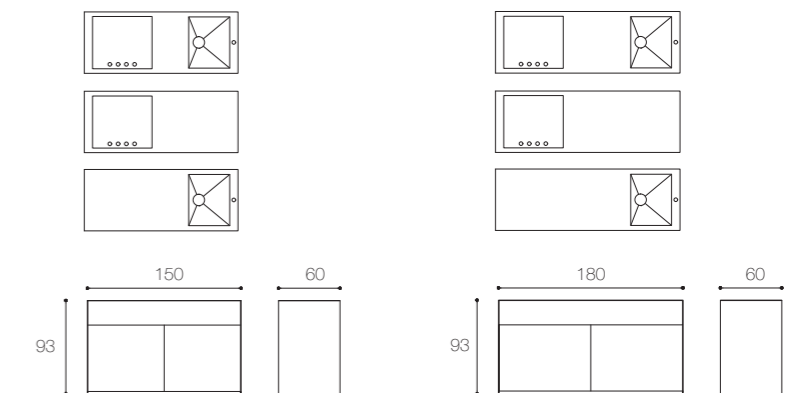



Frontali / Front Panels – Laccati opachi e lucidi / Matt and glossy painted - Cat. 1 / 3

B0 / BL Bianco / White	CU / CJ Calce / Lime	IE / IF Calcare / Limestone	EY / EZ Grigio Exclusive / Exclusive Grey	GF / GT Grafite / Graphite	N2 / N1 Nero / Black	
CB / WB Corda / Rope	ZA / ZI Zolfo / Sulfur	CY / CW Curry / Curry	B1 / BB Biscotto / Cookie	GB / GD Ghiala / Gravel	OA / OB Ombra / Shade	IG / IH Cacao / Cacao
TA / TC Terracotta / Terracotta	MF / MJ Mango / Mango	JA / JB Rosso Jaipur / Jaipur red	C2 / C1 Creta / Clay	TB / T7 Terra / Earth	FM / FP Fumo / Smoke	TM / T6 Testa di Moro / Testa di Moro
II / IL Cenere / Ash	GL / GH Grigio Londra / London Grey	V7 / V8 Verde Agave / Agave Green	CD / CL Argilla / Argilla	PC / PD Pistacchio / Pistachio	VI / VN Visone / Mink	
BC / BD Basalto / Basalt	AZ / A1 Azzurro Polvere / Blue Powder	V1 / V2 Verde Comodoro / Green Commodore	G5 / G6 Grigio Bromo / Bromo Grey	OQ / OS Ottanio / Teal green	BT / BM Blu Notte / Night blue	

Frontali / Front Panels – Legni / Woods

R4 Rovere / Oak	Q2 ALPI Dark Oak	Q1 ALPI Flamed Grey	Q3 ALPI Striped Black
N8 Noce Naturale / Natural Walnut	NC Noce Canaletto / Canaletto Walnut	N6 Noce Bruciato / Burned Walnut	NW Noce Brown / Walnut Brown

Top e fianchi sp 4 mm /
Top and sides 4mm thick

SA Inox satinato Brushed stainless steel

Taglieri e griglie /
Cutting boards and grills

Noce Massello Solid Walnut	HPL Nero Opaco Matt Black
-------------------------------	--

Finiture interne e cassetti / Inside finishings and drawers

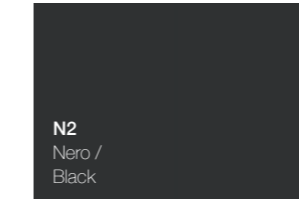

Interni / Inside
Finitura interna dei mobili in
nero opaco. / Internal matt
black finish.



Cassetti interni / Drawers
Cassetti interni in massello di
noce con guide ad estrazione
totale e sistema soft-close.
/ Internal drawers in solid
walnut with full-extraction
runners and soft-close
system.



Cassettoni / Drawers
Cassettoni Legrabox con
fianchi in acciaio finitura
nero opaco e fondo in Noce
Canaletto. Stabilizzatori e
sistema soft-close inclusi.
/ Legrabox drawers with
matt-black finish sides and
Canaletto Walnut bottoms.
Stabilisers and soft-close
system included.



MODEL 2

DESIGN ANDREA FEDERICI

Isola con top e fianchi in acciaio inox con spessore 4mm, disponibile con larghezza 120cm, 150cm e 180cm. Frontali realizzabili nelle finiture legno, nelle laccature lucide e opache e in finitura inox, nelle varianti a catalogo. Disponibile nelle versioni con piano cottura e lavello, solo piano cottura o solo lavello. Il top può essere predisposto per piano cottura a gas o a induzione. I cassetti in noce massello, serie Blum Legrabox con stabilizzatori e soft close integrati, sono completamente estraibili.

Island with 4mm thick stainless steel top and sides, available in 120cm, 150cm and 180cm widths. Fronts available in wood finishes, in glossy and matt lacquers and in stainless steel finishes, in the catalog. Available in versions with hob and sink, hob only or sink only. The top can be fitted for gas or induction hobs. The drawers in solid walnut with Blum Legrabox guides with integrated stabilizers and soft close, are completely removable.

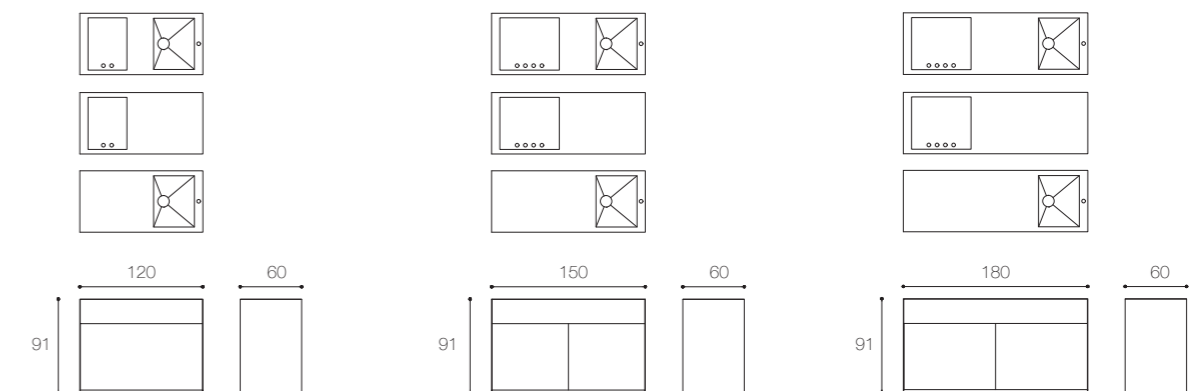



Frontali / Front Panels – Laccati opachi e lucidi / Matt and glossy painted - Cat. 1 / 3

B0 / BL Bianco / White	CU / CJ Calce / Lime	IE / IF Calcare / Limestone	EY / EZ Grigio Exclusive / Exclusive Grey	GF / GT Grafite / Graphite	N2 / N1 Nero / Black	
CB / WB Corda / Rope	ZA / ZI Zolfo / Sulfur	CY / CW Curry / Curry	B1 / BB Biscotto / Cookie	GB / GD Ghiala / Gravel	OA / OB Ombra / Shade	IG / IH Cacao / Cacao
TA / TC Terracotta / Terracotta	MF / MJ Mango / Mango	JA / JB Rosso Jaipur / Jaipur red	C2 / C1 Creta / Clay	TB / T7 Terra / Earth	FM / FP Fumo / Smoke	TM / T6 Testa di Moro / Testa di Moro
II / IL Cenere / Ash	GL / GH Grigio Londra / London Grey	V7 / V8 Verde Agave / Agave Green	CD / CL Argilla / Argilla	PC / PD Pistacchio / Pistachio	VI / VN Visone / Mink	
BC / BD Basalto / Basalt	AZ / A1 Azzurro Polvere / Blue Powder	V1 / V2 Verde Comodoro / Green Commodore	G5 / G6 Grigio Bromo / Bromo Grey	OQ / OS Ottanio / Teal green	BT / BM Blu Notte / Night blue	

Frontali / Front Panels – Legni / Woods

R4 Rovere / Oak	Q2 ALPI Dark Oak	Q1 ALPI Flamed Grey	Q3 ALPI Striped Black
N8 Noce Naturale / Natural Walnut	NC Noce Canaletto / Canaletto Walnut	N6 Noce Bruciato / Burned Walnut	NW Noce Brown / Walnut Brown

Top e fianchi sp 4 mm /
Top and sides 4mm thick

SA Inox satinato Brushed stainless steel

Taglieri /
Cutting boards

Noce Massello Solid Walnut

Finiture interne e cassetti / Inside finishings and drawers

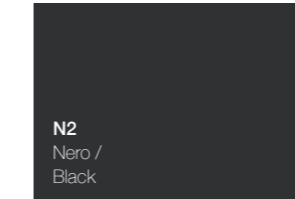
**Interni / Inside**

Finitura interna dei mobili in
nero opaco. / Internal matt
black finish.

**Cassetti interni / Drawers**

Cassetti interni in massello di
noce con guide ad estrazione
totale e sistema soft-close.
/ Internal drawers in solid
walnut with full-extraction
runners and soft-close
system.

**Cassettoni / Drawers**

Cassettoni Legrabox con
fianchi in acciaio finitura
nero opaco e fondo in Noce
Canaletto. Stabilizzatori e
sistema soft-close inclusi.
/ Legrabox drawers with
matt-black finish sides and
Canaletto Walnut bottoms.
Stabilisers and soft-close
system included.



MODEL 3 DESIGN ANDREA FEDERICI

Isola Model 3 interamente realizzata in marmo, alleggerito con inserti interni in honeycomb, realizzabile nei marmi a catalogo. Disponibile con larghezza 120cm, 150cm e 180cm. Disponibile nelle versioni con piano cottura e lavello, solo piano cottura o solo lavello. Il top può essere predisposto per piano cottura a gas o a induzione. I cassetti in noce massello, serie Blum Legrabox con stabilizzatori e soft close integrati, sono completamente estraibili.

Island Model 3 entirely made of marble, lightened with internal honeycomb inserts, available in the marbles in the catalog. Available in 120cm, 150cm and 180cm widths. Available in versions with a hob and sink, hob only or sink only. The top can be fitted for gas or induction hobs. The drawers in solid walnut with Blum Legrabox guides with integrated stabilizers and soft close, are completely removable.

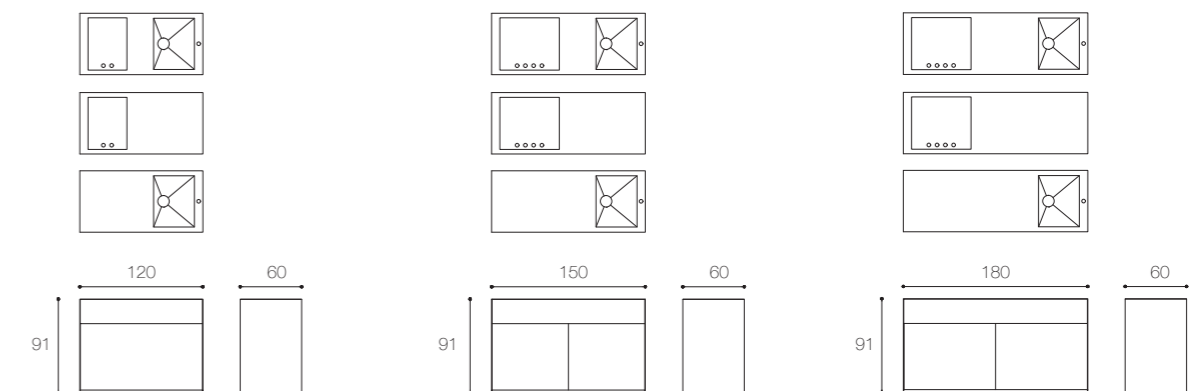



Marmi / Marbles

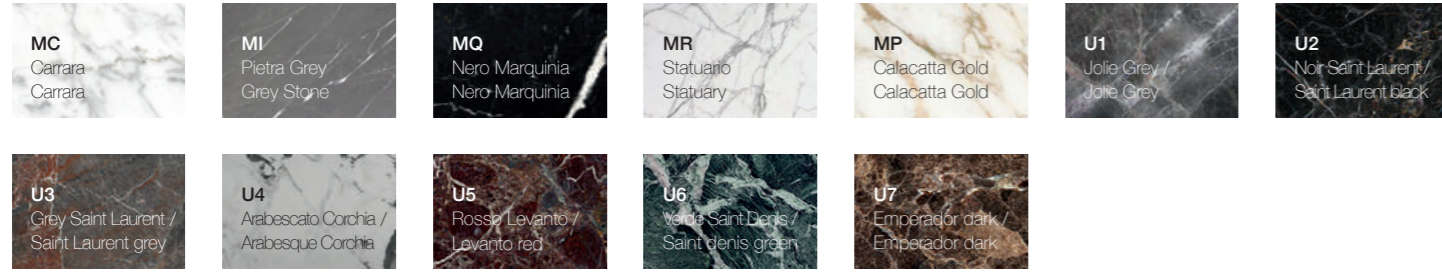

Finiture interne e cassetti / Inside finishings and drawers

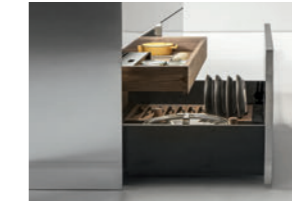
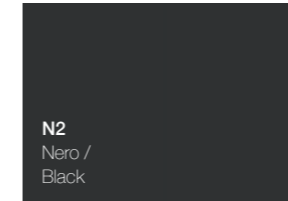

Interni / Inside

Finitura interna dei mobili in nero opaco. / Internal matt black finish.

Cassetti interni / Drawers

Cassetti interni in massello di noce con guide ad estrazione totale e sistema soft-close. / Internal drawers in solid walnut with full-extraction runners and soft-close system.

Cassettoni / Drawers

Cassettoni Legrabox con fianchi in acciaio finitura nero opaco e fondo in Noce Canaletto. Stabilizzatori e sistema soft-close inclusi. / Legrabox drawers with matt-black finish sides and Canaletto Walnut bottoms. Stabilisers and soft-close system included.

MADIE STORAGE UNITS

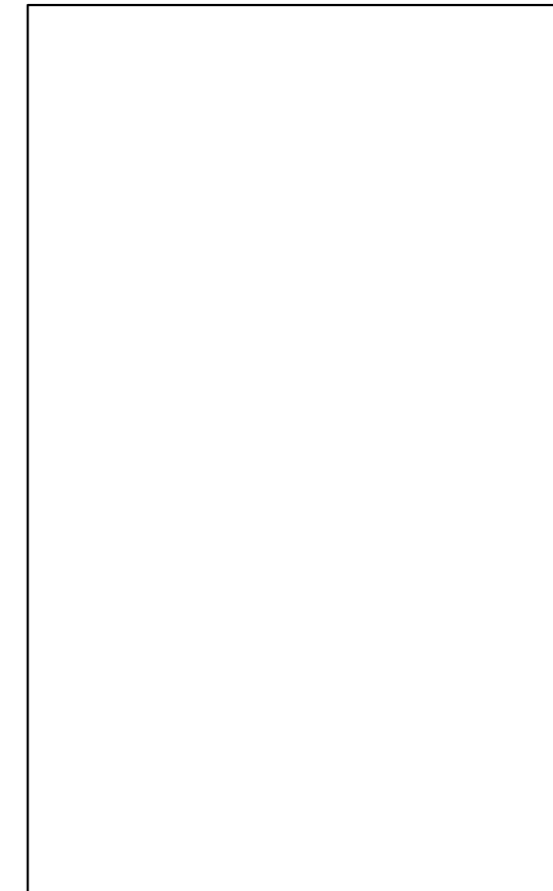

La Madia è un elemento unico, finito su tutti i lati e all'interno, configurabile internamente con undici modelli funzionali. Realizzata in legno multistrato o MDF con impiallaccature in biglia, spessore 22mm e lavorazione a 45°, è disponibile nelle finiture legno e nelle laccature lucide e opache a catalogo. Le ante, con lavorazione a 45°, sono idonee al montaggio di frigoriferi con cerniere portanti e sono fornite con maniglia a tasca verticale. All'interno di vani a giorno e vani dispensa, l'illuminazione LED interna bilaterale funge anche da luce di cortesia. I ripiani e le ante in vetro sono realizzati con frame in alluminio nero opaco e vetro dark grey. Le Madie sono compatibili con elettrodomestici da incasso di dimensioni standard.

The Storage Unit is a single element, finished on all sides and inside, internally configurable with eleven functional models. Made of plywood or MDF with continuous wood grain pattern veneers, 22mm thickness and 45° processing, it is available in the wood finishes and in the glossy and matt lacquers in the catalog. The doors, with 45° machining, are suitable for assembling refrigerators with load-bearing hinges and are supplied with a vertical pocket handle. Inside the open compartments and pantry compartments, the bilateral internal LED lighting also acts as a courtesy light. The shelves and glass doors are made with matt black aluminum frames and dark grey glass. The Storage Units are compatible with standard size built-in appliances.





MADIA 1 / STORAGE UNIT 1

Doppia anta in vetro con frame in alluminio, doppio cassetto interno e mensole in vetro e alluminio.
Double glass door with aluminium frame, double internal drawer and glass and aluminium shelves.

Larghezza / Length (L)
122 cm

Altezza / Height (H)
202 cm

Profondità / Depth (P)
61 cm

Colori disponibili / Available colors — p. 138 - 139

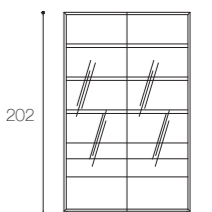
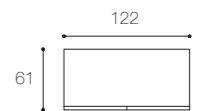



MADIA 2 / STORAGE UNIT 2

Vano a giorno con mensole in vetro e alluminio. Anta con predisposizione dispensa.
Possibilità di configurazione destra o sinistra.
Open compartment with glass and aluminium shelves. Door with pantry set-up.
Option of right or left configuration.

Larghezza / Length (L)
122 cm
Altezza / Height (H)
202 cm
Profondità / Depth (P)
61 cm

Colori disponibili / Available colors — p. 138 - 139

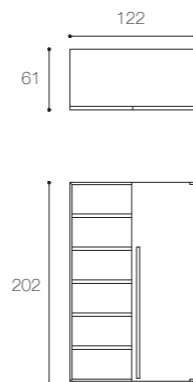

MADIA 2B / STORAGE UNIT 2B

Vano a giorno e mensole in vetro e alluminio. Anta con predisposizione frigorifero da incasso con cerniera portante. Possibilità di configurazione destra o sinistra.
Open compartment with glass and aluminium shelves. Door with built-in refrigerator with load-bearing hinge. Option of right or left configuration.

Larghezza / Length (L)
122 cm
Altezza / Height (H)
202 cm
Profondità / Depth (P)
61 cm

Colori disponibili / Available colors — p. 138 - 139

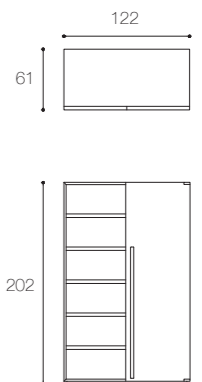



MADIA 3 / STORAGE UNIT 3

Vano a giorno con mensola in vetro e alluminio, predisposizione per forno da incasso h 60cm e due cassetti.
Anta con predisposizione dispensa. Possibilità di configurazione destra o sinistra
Open compartment with a glass and aluminium shelf, set-up for a h 60cm built-in oven and two drawers.
Door with pantry set-up. Option of right or left configuration.

Larghezza / Length (L)
122 cm
Altezza / Height (H)
202 cm
Profondità / Depth (P)
61 cm

Colori disponibili / Available colors — p. 138 - 139

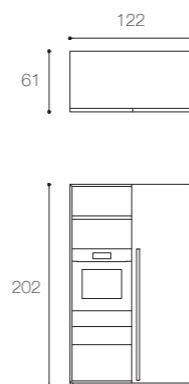

MADIA 3B / STORAGE UNIT 3B

Vano a giorno con mensola in vetro e alluminio, predisposizione per forno da incasso h 60cm e due cassetti.
Anta con predisposizione frigorifero da incasso con cerniera portante.
Possibilità di configurazione destra o sinistra.
Open compartment with a glass and aluminium shelf, set-up for a h 60cm built-in oven and two drawers. Door with built-in refrigerator with load-bearing hinge.
Option of right or left configuration.

Larghezza / Length (L)
122 cm
Altezza / Height (H)
202 cm
Profondità / Depth (P)
61 cm

Colori disponibili / Available colors — p. 138 - 139

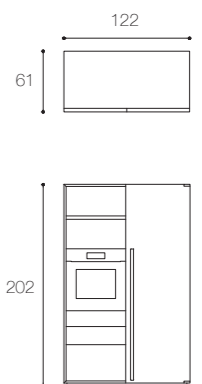



MADIA 4 / STORAGE UNIT 4

Vano a giorno con mensola in vetro e alluminio, predisposizione forno h 45cm e predisposizione lavastoviglie.
Anta con predisposizione dispensa. Possibilità di configurazione destra o sinistra.
Open compartment with a glass and aluminium shelf, h 45cm oven set-up and dishwasher set-up.
Door with pantry set-up. Option of right or left configuration.

Larghezza / Length (L)
122 cm

Altezza / Height (H)
202 cm

Profondità / Depth (P)
61 cm

Colori disponibili / Available colors — p. 138 - 139

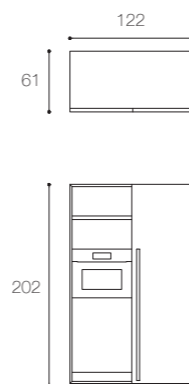

MADIA 4B / STORAGE UNIT 4B

Vano a giorno con mensola in vetro e alluminio, predisposizione forno h 45cm e predisposizione lavastoviglie.
Anta con predisposizione frigorifero da incasso con cerniera portante. Possibilità di configurazione destra o sinistra.
Open compartment with a glass and aluminium shelf, h 45cm oven set-up and dishwasher set-up. Door with built-in refrigerator with load-bearing hinge. Option of right or left configuration.

Larghezza / Length (L)
122 cm

Altezza / Height (H)
202 cm

Profondità / Depth (P)
61 cm

Colori disponibili / Available colors — p. 138 - 139

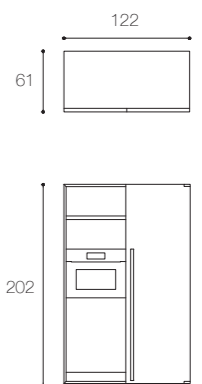



MADIA 5 / STORAGE UNIT 5

Vano a giorno con mensole in vetro e alluminio, vano con presa elettrica per piccoli elettrodomestici e tre cassetti. Anta con predisposizione dispensa. Possibilità di configurazione destra o sinistra.
Open compartment with glass and aluminium shelves, compartment with electrical socket for small appliances and three drawers. Door with pantry set-up. Option of right or left configuration.

Larghezza / Length (L)
122 cm
Altezza / Height (H)
202 cm
Profondità / Depth (P)
61 cm

Colori disponibili / Available colors — p. 138 - 139

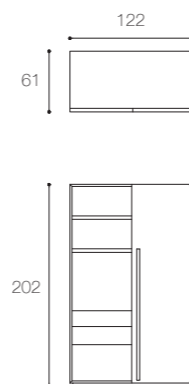

MADIA 5B / STORAGE UNIT 5B

Vano a giorno con mensole in vetro e alluminio, vano con presa elettrica per piccoli elettrodomestici e tre cassetti. Anta con predisposizione frigorifero da incasso con cerniera portante. Possibilità di configurazione destra o sinistra.
Open compartment with glass and aluminium shelves, compartment with electrical socket for small appliances and three drawers. Door with built-in refrigerator with load-bearing hinge. Option of right or left configuration.

Larghezza / Length (L)
122 cm
Altezza / Height (H)
202 cm
Profondità / Depth (P)
61 cm

Colori disponibili / Available colors — p. 138 - 139

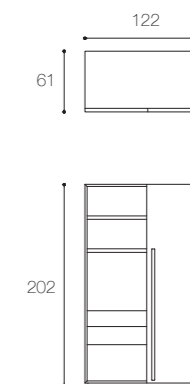



MADIA 6 / STORAGE UNIT 6

Vano a giorno con mensola in vetro e alluminio, predisposizione per lavastoviglie e un cassetto.
Anta con predisposizione dispensa. Possibilità di configurazione destra o sinistra.
Open compartment with a glass and aluminium shelf, dishwasher set-up and one drawer.
Door with pantry set-up. Option of right or left configuration.

Larghezza / Length (L)
122 cm

Altezza / Height (H)
202 cm

Profondità / Depth (P)
61 cm

Colori disponibili / Available colors — p. 138 - 139

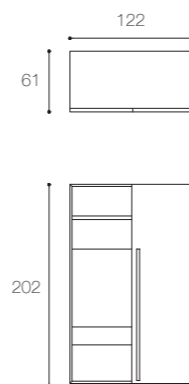

MADIA 6B / STORAGE UNIT 6B

Vano a giorno con mensola in vetro e alluminio, predisposizione per lavastoviglie e un cassetto. Anta con predisposizione frigorifero da incasso con cerniera portante. Possibilità di configurazione destra o sinistra.
Open compartment with a glass and aluminium shelf, dishwasher set-up and one drawer. Door with built-in refrigerator with load-bearing hinge. Option of right or left configuration.

Larghezza / Length (L)
122 cm

Altezza / Height (H)
202 cm

Profondità / Depth (P)
61 cm

Colori disponibili / Available colors — p. 138 - 139

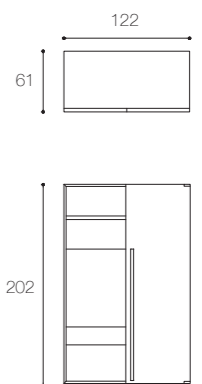

Laccati opachi e lucidi / Matt and glossy painted - Cat. 1 / 3

B0 / BL Bianco / White	CU / CJ Calce / Lime	IE / IF Calcare / Limestone	EY / EZ Grigio Exclusive / Exclusive Grey	GF / GT Grafite / Graphite	N2 / N1 Nero / Black	
CB / WB Corda / Rope	ZA / ZI Zolfo / Sulfur	CY / CW Curry / Curry	B1 / BB Biscotto / Cookie	GB / GD Ghiala / Gravel	OA / OB Ombra / Shade	IG / IH Cacao / Cacao
TA / TC Terracotta / Terracotta	MF / MJ Mango / Mango	JA / JB Rosso Jaipur / Jaipur red	C2 / C1 Creta / Clay	TB / T7 Terra / Earth	FM / FP Fumo / Smoke	TM / T6 Testa di Moro / Testa di Moro
II / IL Cenere / Ash	GL / GH Grigio Londra / London Grey	V7 / V8 Verde Agave / Agave Green	CD / CL Argilla / Argilla	PC / PD Pistacchio / Pistachio	VI / VN Visone / Mink	
BC / BD Basalto / Basalt	AZ / A1 Azzurro Polvere / Blue Powder	V1 / V2 Verde Comodoro / Green Commodore	G5 / G6 Grigio Bromo / Bromo Grey	OQ / OS Ottanio / Teal green	BT / BM Blu Notte / Night blue	

Legni / Woods

R4 Rovere / Oak	Q2 ALPI Dark Oak	Q1 ALPI Flamed Grey	Q3 ALPI Striped Black
N8 Noce Naturale / Natural Walnut	NC Noce Canaletto / Canaletto Walnut	N6 Noce Bruciato / Burned Walnut	NW Noce Brown / Walnut Brown

Finiture ante / Doors Finishings

Aluminio nero opaco Matt black aluminum	Vetro dark grey Dark Grey mirror
--	-------------------------------------

Finiture interne e cassetti / Inside finishings and drawers

N2 Nero / Black

**Interni / Inside**

Finitura interna dei mobili in nero opaco. / Internal matt black finish.

Cassetti e cassettoni / Drawers

Cassetti e cassettoni Legrabox con fianchi in acciaio finitura nero opaco e fondo in Noce Canaletto. Stabilizzatori e sistema soft-close inclusi. / Legrabox drawers with matt-black finish sides and Canaletto Walnut bottoms. Stabilisers and soft-close system included.

COLONNE TALL UNITS

Le Colonne sono elementi componibili, combinabili tra loro per creare una vera e propria parete attrezzata, e configurabili internamente in molteplici modelli funzionali. Sono costituite da elementi da 60/64cm con predisposizione per frigorifero e dispensa, da elementi centrali da 120cm con ante a scomparsa e da Sopra-Colonne realizzabili su misura in altezza. Le Colonne sono in legno multistrato o MDF con impiallacciate in biglia, spessore 19mm. Ante a scomparsa di ultimissima generazione con nuovo sistema Blum Pocket con maniglie a tasca verticale o Push Pull. Le ante singole per frigorifero a traino hanno bordi con lavorazione a 45°. Ante e fianchi sono disponibili nelle finiture legno e nelle laccature lucide e opache a catalogo. Interni in nero opaco o, su richiesta, in noce canaletto. All'interno di vani a giorno e vani dispensa, l'illuminazione LED interna bilaterale funge anche da luce di cortesia.

The Tall Units are modular elements, which can be combined together to create a real equipped wall, and internally configurable in multiple functional models. They consist of 60/64cm elements with preparation for refrigerator and pantry, 120cm central elements with retractable doors and customizable Above-Tall Units. The Tall Units are in plywood or MDF with continuous wood grain pattern veneers, 19mm thick. Retractable doors of the latest generation with the new Blum Pocket system with vertical pocket or Push Pull handles. The single doors for pull-out refrigerators have edges with 45° processing. Doors and sides are available in the wood finishes and in the glossy and matt lacquers in the catalog. Interior in matt black or, on request, in canaletto walnut. Inside the open compartments and pantry compartments, the bilateral internal LED lighting also acts as a courtesy light.

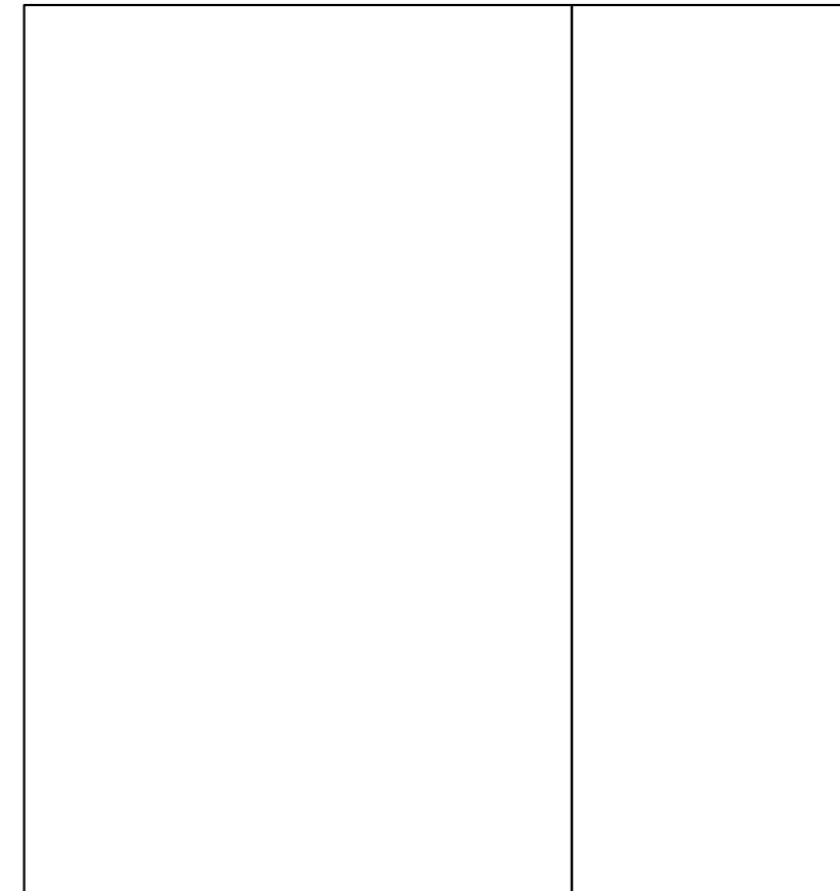





COLONNA A / TALL UNIT A

Doppia anta a scomparsa, configurazione con mensole a giorno, predisposizione per forno h 45cm e tre cassettoni.
Double retractable door, configuration with open shelves, h 45cm oven set-up and three drawers.

Larghezza / Length (L)
120 cm

Altezza / Height (H)
202 cm

Profondità / Depth (P)
70 cm

Colori disponibili / Available colors — p. 152 - 153

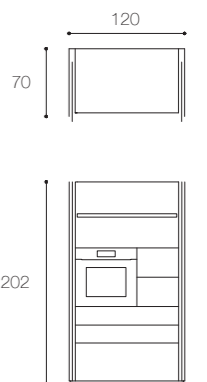



COLONNA B / TALL UNIT B

Doppia anta a scomparsa, configurazione con mensole a giorno, predisposizione per forno h 45cm, predisposizione per lavastoviglie e tre cassetti.
Double retractable door, configuration with open shelves, h 45cm oven set-up, dishwasher set-up and three drawers.

Larghezza / Length (L)
120 cm

Altezza / Height (H)
202 cm

Profondità / Depth (P)
70 cm

Colori disponibili / Available colors — p. 152 - 153

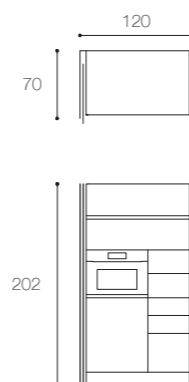

COLONNA B1 / TALL UNIT B1

Doppia anta a scomparsa, configurazione con mensole a giorno, predisposizione per forno h 45cm e predisposizione per lavastoviglie.
Double retractable door, configuration with open shelves, h 45cm oven set-up and dishwasher set-up.

Larghezza / Length (L)
120 cm

Altezza / Height (H)
202 cm

Profondità / Depth (P)
70 cm

Colori disponibili / Available colors — p. 152 - 153

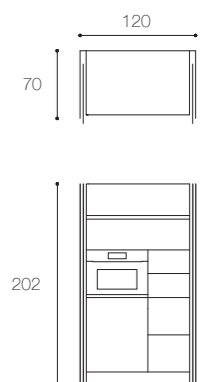



COLONNA D1 / TALL UNIT D1

Doppia anta a scomparsa, configurazione con mensole a giorno, predisposizione per lavastoviglie e un cassetto.
Double retractable door, configuration with open shelves, dishwasher set-up and one drawer.

Larghezza / Length (L)
120 cm
Altezza / Height (H)
202 cm
Profondità / Depth (P)
70 cm

Colori disponibili / Available colors — p. 152 - 153

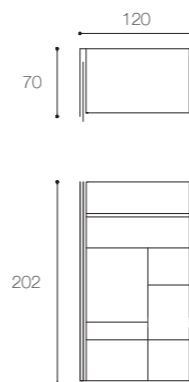

COLONNA F / TALL UNIT F

Doppia anta a scomparsa, configurazione con mensole a giorno e tre cassettoni.
Double retractable door, configuration with open shelves and three drawers.

Larghezza / Length (L)
120 cm
Altezza / Height (H)
202 cm
Profondità / Depth (P)
70 cm

Colori disponibili / Available colors — p. 152 - 153

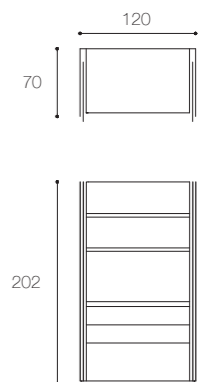



COLONNA ANTA SINGOLA DISPENSA / SINGLE DOOR TALL UNIT FOR PANTRY

Configurazione con predisposizione per dispensa.
Disponibile con apertura sul lato destro o sinistro del mobile.
Layout for pantry. Available with opening on the right or left side
of the storage unit.

Larghezza / Length (L)
64 cm
Altezza / Height (H)
202 cm
Profondità / Depth (P)
70 cm

Colori disponibili / Available colors — p. 152 - 153

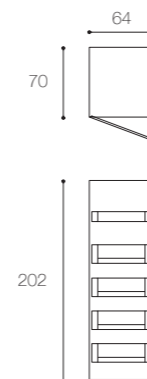

COLONNA ANTA SINGOLA FRIGO / SINGLE DOOR TALL UNIT FOR REFRIGERATOR

Configurazione con predisposizione per frigorifero con cerniere portanti (L60) o a traino (L64).
Disponibile con apertura sul lato destro o sinistro del mobile.
Layout for refrigerator with load-bearing (L60) or sliding (L64) hinge. Available with opening
on the right or left side of the storage unit.

Larghezza / Length (L)
60 - 64 cm
Altezza / Height (H)
202 cm
Profondità / Depth (P)
70 cm

Colori disponibili / Available colors — p. 152 - 153

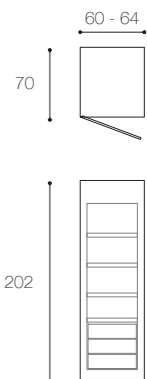

Laccati opachi e lucidi / Matt and glossy painted - Cat. 1 / 3

B0 / BL Bianco / White	CU / CJ Calce / Lime	IE / IF Calcare / Limestone	EY / EZ Grigio Exclusive / Exclusive Grey	GF / GT Grafite / Graphite	N2 / N1 Nero / Black	
CB / WB Corda / Rope	ZA / ZI Zolfo / Sulfur	CY / CW Curry / Curry	B1 / BB Biscotto / Cookie	GB / GD Ghiata / Gravel	OA / OB Ombra / Shade	IG / IH Cacao / Cacao
TA / TC Terracotta / Terracotta	MF / MJ Mango / Mango	JA / JB Rosso Jaipur / Jaipur red	C2 / C1 Creta / Clay	TB / T7 Terra / Earth	FM / FP Fumo / Smoke	TM / T6 Testa di Moro / Testa di Moro
II / IL Cenere / Ash	GL / GH Grigio Londra / London Grey	V7 / V8 Verde Agave / Agave Green	CD / CL Argilla / Argilla	PC / PD Pistacchio / Pistachio	VI / VN Visone / Mink	
BC / BD Basalto / Basalt	AZ / A1 Azzurro Polvere / Blue Powder	V1 / V2 Verde Comodoro / Green Commodore	G5 / G6 Grigio Bromo / Bromo Grey	OQ / OS Ottanio / Teal green	BT / BM Blu Notte / Night blue	

Legni / Woods

R4 Rovere / Oak	Q2 ALPI Dark Oak	Q1 ALPI Flamed Grey	Q3 ALPI Striped Black
N8 Noce Naturale / Natural Walnut	NC Noce Canaletto / Canaletto Walnut	N6 Noce Bruciato / Burned Walnut	NW Noce Brown / Walnut Brown

Finiture interne e cassetti / Inside finishings and drawers

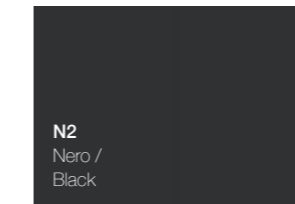

Interni / Inside
Finitura interna dei mobili in
nero opaco. / Internal matt
black finish.



**Cassetti e cassettoni /
Drawers**
Cassetti e cassettoni Leg-
rabox con fianchi in acciaio
finitura nero opaco e fondo
in Noce Canaletto. Stabiliz-
zatori e sistema soft-close
inclusi. / Legrabox drawers
with matt-black finish sides
and Canaletto Walnut bot-
toms. Stabilisers and soft-
close system included.



**Optional fianchi esterni
finiti / Optional finished
exterior sides**



**Optional interni in Noce
Canaletto / Optional
interior in Walnut**

ACCESSORI / ACCESSORIES

Gli accessori Small Living Kitchens™ completano gli elementi contenitivi delle cucine. Progettati con gli stessi stili della collezione, gli accessori consentono di personalizzare i cassetti di Isole, Madie e Colonne. Materiali preziosi, dettagli artigianali e un design essenziale danno vita ad oggetti di straordinaria raffinatezza che consentono di tenere ogni cosa al suo posto e a portata di mano.

Accanto agli elementi divisorii e contenitivi, Falper firma anche tre set Wine e Food, pensati per i palati più raffinati e per i clienti più esigenti: Set Cocktail, Set Condimenti e Set Vino.

Small Living Kitchens™ accessories complement the kitchen storage elements. Designed with the same stylistic features as the collection, the accessories allow you to customize the drawers of Islands, Storage Units and Tall Units. High-quality materials, handcrafted details and minimalist designs create very sophisticated objects that allow you to keep everything in its place and within reach. In addition to the dividing and storage elements, Falper has also created three Wine and Food sets designed for the most discerning palates and for the most demanding customers: Cocktail Set, Condiment Set and Wine Set.





ACCESSORI PER CASSETTI ISOLE, MADIE E COLONNE DRAWER ACCESSORIES FOR ISLANDS, STORAGE UNITS AND TALL UNITS

Gli accessori per cassetti portaposate sono compatibili con Isole, Madie e Colonne. Possono essere arricchiti da accessori opzionali come portacoltelli, portapelliole, portaspezie, contenitori in vetro, portacialde caffè, set cocktail e set vino. Accessories for cutlery drawers are compatible with Islands, Storage Units and Tall Units. They can be enhanced with optional accessories like knife holders, film holders, spice racks, glass containers, coffee pod holders, cocktail sets and wine sets.

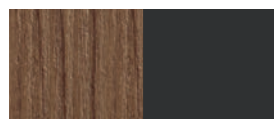

NC / N2
Noce Canaletto e nero /
Canaletto Walnut and Black

Accessori / Accessories



Portaposate – Accessorio portaposate e divisorio per organizzare i cassetti, utilizzabile anche per alloggiare gli Accessori Opzionali di categoria A.
Cutlery Insert – Cutlery holder/divider/drawer organiser, can also be used to hold the Optional Accessories in category A.



Portaposate – Accessorio portaposate e divisorio per organizzare i cassetti, utilizzabile anche per alloggiare gli Accessori Opzionali di categoria A e B.
Cutlery Insert – Cutlery holder/divider/drawer organiser, can also be used to hold the Optional Accessories in category A and B.



Portaposate – Accessorio portaposate e divisorio per organizzare i cassetti, utilizzabile anche per alloggiare gli Accessori Opzionali di categoria A e B.
Cutlery Insert – Cutlery holder/divider/drawer organiser, can also be used to hold the Optional Accessories in categories A and B.

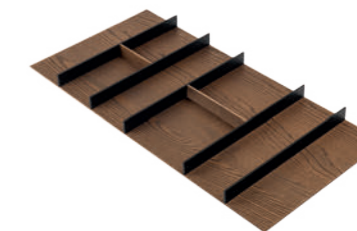

Portaposate – Accessorio portaposate e divisorio per organizzare i cassetti, utilizzabile anche per alloggiare gli Accessori Opzionali di categoria A e B.
Cutlery Insert – Cutlery holder/divider/drawer organiser, can also be used to hold the Optional Accessories in categories A and B.

Accessori Opzionali / Optional Accessories



A
Portaspezie – Accessorio con barattoli in vetro dove riporre spezie, sali o alimenti di piccole dimensioni.
Spice Rack – Accessory with glass jars to hold spices, salt, seasonings, etc.



A
Portacoltelli – Accessorio dove riporre i coltelli in modo stabile e sicuro.
Knife Holder – Accessory to firmly and safely hold knives.



A
Portapelliole – Doppio dispenser con anima porta tubo per facilitare la rotazione.
Film Holder – Double dispenser with tube holder to facilitate rotation.



A
Portacialde – Dispenser con capacità fino a 30 cialde o capsule del caffè.
Pod Holder – Dispenser where to store up to 30 coffee pods or capsules.



B
Portaspezie Quadrato V – Accessorio con barattoli in vetro dove riporre spezie, sali o alimenti di piccole dimensioni.
Spice Rack Square V – Accessory with glass jars to hold spices, salt, seasonings, etc.



B
Set Cocktail – Accessorio completo di strumenti per la preparazione di cocktails (shaker, jigger, pinza ghiaccio, pestello).
Cocktail Set – Accessory complete with cocktail-making tools (shaker, jigger, ice tongs, pestle).



B
Set Condimenti – Accessorio completo di 4 minimacina per spezie o sali e 2 oliere da 250ml in acciaio inox.
Condiments Set – Accessory with 4 small spice or salt grinders and 2 250-ml stainless steel oil jars.



B
Set Vino – Set degustazione vino (cavatappi professionale Roero, tappo champagne, salva goccia, versatore vino in acciaio inox, preserva vino con due tappi in silicone).
Wine Set – Set for wine tasting (Roero professional corkscrew, champagne cork, drop saver, stainless steel wine pourer, wine preserves with two silicone stoppers).



ACCESSORI PER CASSETTONI DEEP DRAWER ACCESSORIES

Gli accessori per cassettoni sono compatibili con Isole, Madie e Colonne. Sono stati studiati e configurati in base a funzioni di contenimento specifiche: portapentole con guarnizioni antiscivolo, portapiatti con pilastri di contenimento e portacoperchi, portabottiglie, portabicchieri e contenitori per raccolta rifiuti. Drawer accessories are compatible with Islands, Storage Units and Tall Units. They are designed and configured for specific storage functions: pot holders with non-slip trim, dish holders with dividing rods, lid holders, bottle holders, glass holders and waste collection containers.

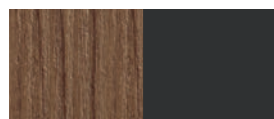

NC / N2
Noce Canaletto e nero /
Canaletto Walnut and Black

Accessori / Accessories



Portapentole – Accessorio portapentole con fondo antiscivolo.

Pot Holder – Pot holder accessory with non-slip bottom.



Portapiatti – Accessorio per riporre i piatti in maniera ordinata e sicura.

Dish Holder – Accessory to neatly and safely hold dishes.



Portapiatti con divisori – Accessorio per riporre i piatti in maniera ordinata e sicura, con divisori laterali.

Dish Holder with dividers – Accessory to neatly and safely hold dishes, with side dividers.



Portapentole con portacoperchi – Accessorio portapentole con fondo antiscivolo, porta coperchi e divisorio laterale.

Pot Holder with Lids Holder – Pot holder accessory with non-slip bottom, lids holder and side divider.

Accessori Opzionali / Optional Accessories



Portabottiglie – Vassoio con divisorio per riporre fino ad 8 bottiglie.

Bottle Holder – Tray with divider for storing up to 8 bottles.



Box Accessori – Vassoio dove poter alloggiare bottiglie e vani per posate o altri accessori.

Box Accessories – Tray where bottles and compartments for cutlery or other accessories can be stored.



Portabicchieri – Vassoio con divisori per riporre fino ad 8 bicchieri.

Glass Holder – Tray with dividers for storing up to 8 glasses.



Raccolta rifiuti – Accessorio per raccolta rifiuti con doppio contenitore.

Waste collection – Double-container accessory for waste collection.



Raccolta rifiuti – Accessorio per raccolta rifiuti con triplo contenitore.

Waste collection – Triple-container accessory for waste collection.

ISOLE + MADIE / ISLANDS + STORAGE UNITS

ISOLE + COLONNE / ISLANDS + TALL UNITS



inspirations #01
p. 24 - 35



inspirations #02
p. 36 - 41



inspirations #05
p. 60 - 69



inspirations #06
p. 70 - 79



inspirations #03
p. 42 - 51



inspirations #04
p. 52 - 57



inspirations #07
p. 80 - 85



inspirations #08
p. 86 - 91



inspirations #09
p. 92 - 99

credits

ad
chiara boselli studio

graphic design
bianca previato schiesari

photo
alberto strada

rendering
in-edito

styling
bruno tarsia studio

copy
cora manzi

print
grafiche antiga
may 2022

thanks to

alessi
ceramiche bucci
coltellerie berti
corrado corradi
covo
delamont
dome deco
dutchdeluxes
fiammettav
fiskars
il giardino di legno
iittala
knindustrie
mepra
molto luce
plinio il giovane
sagaform
scandola marmi
secondome
serafino zani
stilleben
zeus noto

Falper srl
Via Veneto 7 — 9
40064 Ozzano Emilia, Bologna (Italy)
Tel + 39 051 799319
Fax + 39 051 796495
info@falper.it
www.falper.it

falper.

falper.

falper.it