

SALONE 2023 BATHROOM COLLECTION PREVIEW

LISTINO PREZZI / PRICE LIST

falper.



Variazioni prezzi relative ai listini news 2023 bagno e cucina

Aumento generale + 4%

Aumento Lavabo Eccentrico Freestanding con base in legno rigato: +10 %

Price Changes on News Pricelists 2023 for Bathroom and Kitchen:

General Increase: +4%;

Increase for Freestanding Eccentric Basin with striped wooden base: +10%.

Preisänderungen für die Neuheitspreislisten 2023 für Bad und Küche:

Allgemeine Erhöhung: + 4%

Erhöhung des freistehenden Waschbeckens Eccentrico mit gestreifter Holzbasis: +10%

Augmentations de prix relatives aux tarifs nouveautés 2023 pour salle de bains et cuisine :

Augmentation générale : +4%

Augmentation Lavabo Eccentrico Freestanding avec base en bois rayé : +10%

Variaciones de precios en listados de novedades 2023 para baño y cocina:

Aumento general +4%

Aumento Lavabo Eccentrico Freestanding con base de madera rayada: +10%

2022|2023 Price List

falper.

Listino prezzi in punti
Price list in points
Preisliste in Punkten
List de prix en points
Tarifa de precios en puntos



Indice della collezione
Index of the collection

Com'è fatto How is it made	Pag. 02
Finiture Finishings	Pag. 04
Optionals Optionals	Pag. 09
Basi per lavabi da appoggio Bases for countertop washbasins	Pag. 10
Lavabi Washbasins	Pag. 12
Bocche di erogazione Spouts	Pag. 14



COM'È FATTO | HOW IS IT MADE

| WIE IST ES AUFGEBAUT | COMMENT EST-IL FAIT | CÓMO ESTÁ REALIZADO

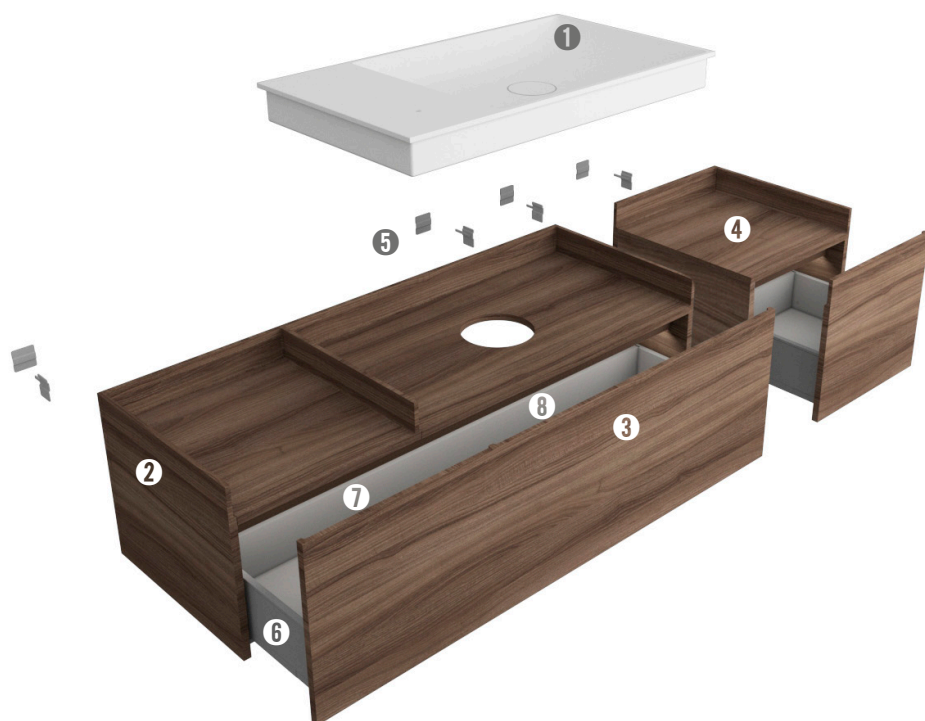

**1 Lavabo da appoggio compatibile solo con collezione MA
Countertop basin compatible only with the MA Collection**

Aufsatzwaschbecken, kompatibel nur mit MA-Kollektion
Vasque à poser compatible uniquement avec la collection MA
Lavabo sobre encimera compatible solo con la colección MA

**2 Base a un cassetto con fianchi finiti
One-drawer unit with finished sides**

Unterschrank mit einer Schublade und fertigen Seiten
Meuble bas à un tiroir avec côtés finis
Mueble bajo de un cajón con laterales acabados

**3 Frontali con maniglie fresate su legno massello
Fronts with handles milled out of solid wood**

Fronten mit Griffen aus Massivholz gefräst
Façades avec poignées fraisées en bois massif
Frentes con tiradores fresados en madera maciza

**4 Base laterale opzionale a un cassetto, destra o sinistra
Optional side base with one drawer, right or left**

Optionaler seitliche Basis mit einer Schublade, rechts oder links
Base latérale en option avec un tiroir, à droite ou à gauche
Base lateral opcional con un cajón, derecho o izquierdo.

**5 Attaccaglie ad alta portata regolabili con sistema di anti-sganciamento
Adjustable High capacity hangers with anti-detachment safety system**

Regulierbare Wandbefestigungen mit hoher Belastbarkeit und Sicherheitssystem gegen Aushängen
Accroches murales réglables à haute capacité de charge avec système anti-décrochage de sécurité
Fijaciones de pared regulables de alta capacidad con sistemas anti-desenganche de seguridad

**6 Cassetti di serie Blum Legrabox con stabilizzatori (oltre L 90 cm) e soft close integrati. Finitura Grigio Exclusive
Blum Legrabox drawers with built-in stabilisers (over L 90 cm) and soft close Exclusive Grey Finishing**

Serienmäßige Schubladen Legrabox mit integrierten Soft-Close und Stabilisatoren (L über 90 cm). Finish Grau Exclusive
Tiroirs de série Blum Legrabox avec stabilisateurs (plus de 90 cm de l.) et soft close intégrés. Finition Gris Exclusive
Cajones de serie Blum Legrabox con estabilizadores (más de L 90 cm) y cierre suave integrados. Acabado gris Exclusive

**7 Parti interne al mobile in finitura grigio Exclusive opaco
Parts inside the furniture in Exclusive matt grey finish**

Innenteile des Möbels in Farbe Grau Exclusive matt
Parties internes au meuble en finition gris Exclusive mat
Partes internas del mueble en acabado gris Exclusive mate

**8 Illuminazione Led interna orizzontale – opzionale
Horizontal internal LED lighting – optional**

Horizontale interne LED-Beleuchtung – optional
Eclairage LED interne horizontal - en option
Iluminación LED interna horizontal - opcional

COMPRESO | INCLUDED | INBEGRIFFEN | INCLU | INCLUIDO

**Predisposizione per sifoni STANDARD
Preparation for STANDARD drain-trap**
Vorbereitung für STANDARD Siphon
Prédisposition pour les siphons STANDARD
Predisposición para sifones ESTÁNDAR



OPTIONAL GRATUITO | FREE OF CHARGE OPTIONAL | KOSTENLOSE AUSSTATTUNG
| EN OPTION GRATUITEMENT | OPCIONAL GRATUITO

**Art. DS4 - Predisposizione per sifone VIEGA (art. 52K)
Art. DS4 - Installation-ready for VIEGA drain-trap (p/n 52K)**
Art. DS4 - Vorbereitung für VIEGA Siphon (Art. Nr. 52 K)
Art. DS4 - Prédisposition pour siphon VIEGA
Art. DS4 - Predisposición para sifon VIEGA



Per informazioni su materiali utilizzati e loro cura e manutenzione vedi pag. 8 | For information on the materials used and their care and maintenance see page 8 | Für Informationen zu den verwendeten Materialien sowie ihrer Pflege und Instandhaltung siehe S. 8 | Pour des informations sur les matériaux utilisés et leur soin et entretien, voir page 609 | Para informaciones sobre materiales utilizados y sobre su cuidado y mantenimiento, véase pag. 8

COM'È FATTO | HOW IS IT MADE

| WIE IST ES AUFGEBAUT | COMMENT EST-IL FAIT | CÓMO ESTÁ REALIZADO

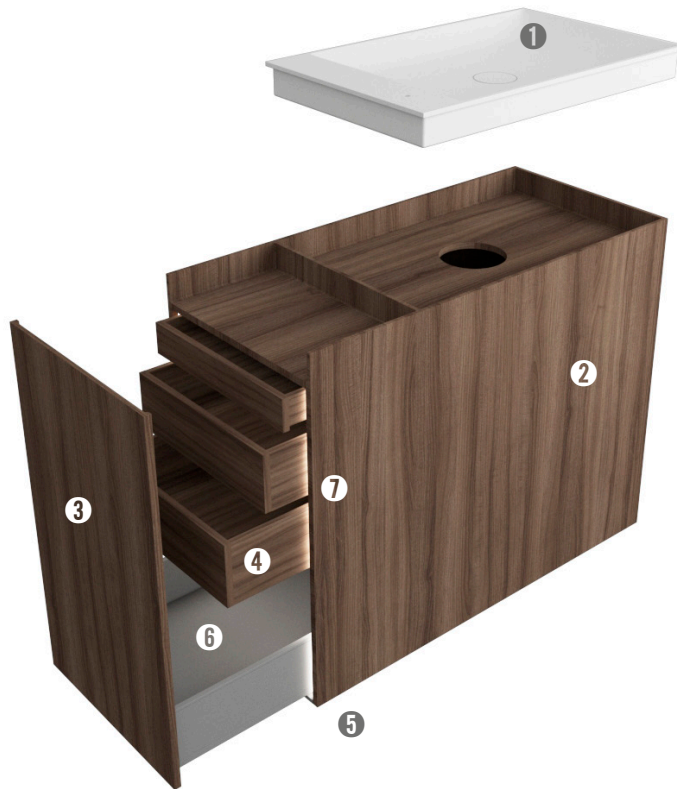

- 1 Lavabo da appoggio compatibile solo con collezione MA**
Countertop basin compatible only with the MA Collection
Aufsatzwaschbecken, kompatibel nur mit MA-Kollektion
Vasque à poser compatible uniquement avec la collection MA
Lavabo sobre encimera compatible solo con la colección MA
- 2 Base isola con posizionamento a terra**
Floorstanding island base
Bodenstehende Basis mit Bodenpositionierung
Base îlot avec positionnement au sol
Base de isla con posicionamiento en el suelo
- 3 Frontale con maniglia fresate su legno massello**
Front with handle milled out of solid wood
Fronte mit Griff aus Massivholz gefräst
Façade avec poignées fraisées en bois massif
Frente con tirador fresado en madera maciza
- 4 Cassetti interni in legno e soft close integrato realizzati nella stessa finitura del mobile (in caso di mobile laccato lucido, i cassetti interni saranno realizzati nella stessa finitura ma opaca)**
Internal wooden drawers with integrated soft close in the same finish of the furniture (in the case of glossy lacquered furniture, the internal drawers will be made in the same finishing but in matt version)
Innenschubladen aus Holz mit integriertem Soft Close in der gleichen Farbe des Möbels (bei glänzend lackierten Möbeln werden die Innenschubladen im gleichen, jedoch matten Farbe gefertigt)
Tiroirs internes en bois avec fermeture soft close intégrée réalisés dans la même finition que le meuble (dans le cas de meubles en laqués brillants, les tiroirs intérieurs seront réalisés dans la même finition mais en mate)
Cajones internos en madera y cierre soft close integrado realizados en el mismo acabado que el mueble (en el caso de muebles lacados brillo, los cajones internos se realizarán en el mismo acabado pero en mate)
- 5 Piedini regolabili**
Height adjustable feet
Höhenverstellbare Füße
Pieds réglables en hauteur
Pies regulables en altura
- 6 Parti interne al mobile in finitura grigio Exclusive opaco**
Parts inside the furniture in Exclusive matt grey finish
Innenteile des Möbels in Farbe Grau Exclusive matt
Parties internes au meuble en finition gris Exclusive mat
Partes internas del mueble en acabado gris Exclusive mate
- 7 Illuminazione Led interna verticale – opzionale**
Vertical internal Led lighting – optional
Vertikale LED-Innenbeleuchtung – optional
Eclairage Led interne vertical – en option
Iluminación Led interna vertical – opcional

FINITURE | FINISHINGS

| OBERFLÄCHE | FINITIONS | ACABADOS

Cat. 1/3

Laccati opachi e lucidi | Finishing in matt and glossy colours | Matte und glänzende Farben | Coloris mates et brillantes | Acabados mates y brillantes

						
B0/BL Bianco White Weiß Blanc Blanco	CU/CJ Calce Lime Kalk Chaux Cal	IE/IF Calcare Limestone Kalkstein Calcaire Caliza	CB/WB Corda Rope Seil Corde Cuerda	ZA/ZI Zolfo Sulfur Schwefel Soufre Azufre	CY/CW Curry Curry Curry Curry Curry	B1/BB Biscotto Cookie Keks Biscuit Galleta
						
GB/GD Ghiaia Gravel Kies Gravier Grava	OA/OB Ombra Shade Schatten Ombre Sombra	IG/IH Cacao Cacao Kakao Cacao Cacao	TA/TC Terracotta Terracotta Terrakotta Terre cuite Terracota	MF/MJ Mango Mango Mango Mango Mango	JA/JB Rosso Jaipur Jaipur red Jaipur Rot Rouge Jaipur Rojo Jaipur	C2/C1 Creta Clay Ton Crête Creta
						
TB/T7 Terra Earth Erde Terre Tierra	FM/FP Fumo Smoke Rauch Fumée Humo	TM/T6 Testa di Moro Testa di Moro Testa di Moro Testa di Moro Testa di Moro	II/IL Cenere Ash Asche Cendre Ceniza	GL/GM Grigio Londra London grey London Grau Gris Londres Gris Londres	V7/V8 Verde Agave Agave Green Agave Grau Vert agave Verde Agave	CD/CL Argilla Argilla Argilla Argilla Argilla
						
PC/PD Pistacchio Pistachio Pistazie Pistache Pistacho	VI/VN Visone Mink Nerz Vison Visòn	BC/BD Basalto Basalt Basalt Basalte Basalto	AZ/A1 Azzurro polvere Blue powder Blau Puder Bleu poudre Azul pálido	V1/V2 Verde Comodoro Green Commodore Commodore Grün Vert Commodore Verde Comodoro	G5/G6 Grigio Bromo Bromo grey Bromo Grau Gris Bromo Gris Bromo	OQ/OS Ottanio Teal green Teal Grün Vert Teal Verde Teal
						
BT/BM Blu Notte Night blue Nachtblau Blue nuit Azul noche	EY/EZ Grigio Exclusive Exclusive grey Exclusive Grau Gris Exclusive Gris Exclusive	GF/GT Grafite Graphite Graphit Graphite Grafito	N2/N1 Nero Black Schwarz Noir Negro			



COLORI CAMPIONE - Per i colori laccati a campione aggiungere 519 punti a composizione. | Sample colours - For sample colours add 519 points for each composition. | Farbmuster - Für Lackierungen nach Farbmuster 519 Punkten pro Komposition zurechnen. | Coloris sur échantillon - Pour les coloris laqués sur échantillon, supplément de 519 points par composition. | Colores por muestrarios - Para los colores laqueados según muestrario añadir 519 puntos por composición.

FINITURE | FINISHINGS

| OBERFLÄCHE | FINITIONS | ACABADOS

Cat. 2

Legni | Woods | Holz | Bois | Maderas



Q8 ALPI
Striped White



Q1 ALPI
Flamed Grey



N8 Noce naturale
Natural walnut
Nussbaum Natur
Noyer naturel
Nogal naturales



NC Noce Canaletto
Canaletto walnut
Nussbaum Canaletto
Noyer Canaletto
Nogal Canaletto



N6 Noce bruciato
Walnut burned
Nussbaum gebrannt
Noyer brûlé
Nogal quemado



NW Noce Brown
Walnut Brown
Nussbaum braun
Noyer Foncé
Nogal marrón

Le finiture in legno cat. 2 possono essere richieste con venatura continua (in "biglia") | The cat. 2 wooden finishings can have a continuous wood grain pattern on request | Auf Anfrage können Holzfarbe der Cat. 2 ein kontinuierliche Holzmaserung aufweisen | Les finitions bois cat. 2 peuvent avoir les veines continues sous demande | Los acabados de madera cat 2 pueden tener un patrón de grano de madera continuo a petición

Art.

**Prezzo
Price**

DSF Optional frontali in "Biglia" | Optional front with a continuous wood grain pattern | Option Fronten mit einer kontinuierlichen Holzmaserung | Option façade avec veines continues | Opción Frontes cajones con patrón de grano de madera continuo

+ 15 %

FINITURE | FINISHINGS

| OBERFLÄCHE | FINITIONS | ACABADOS

Lavabi | Washbasins | Waschbecken | Lavabos | Lavabos

Marmi

Marmi 1 | Marbles 1 | Marmor 1 | Marbres 1 | Marmor 1



MC Carrara
Carrara
Carrara
Carrara
Carrara

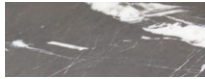

MI Pietra grey
Grey Stone
Grey stone
Grauer Stein
Pierre grise



U3 Grey Saint Laurent
Saint Laurent grey
Grau Saint Laurent
Gris Saint Laurent
Gris Saint Laurent

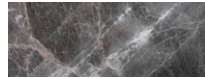

U1 Jolie Grey
Jolie Grey
Jolie Grey
Jolie Grey
Jolie Grey

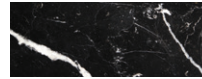

MQ Nero Marquina
Nero Marquina
Nero Marquina
Nero Marquina
Nero Marquina

Marmi 2 | Marbles 2 | Marmor 2 | Marbres 2 | Marmor 2



MR Statuario
Statuary
Statuarisch
Statuaire
Estatuario



MP Calacatta Gold
Calacatta Gold
Calacatta Gold
Calacatta Gold
Calacatta Gold



U4 Arabescato Corchia
Arabesque Corchia
Arabesque Corchia
Arabesque Corchia
Arabesque Corchia

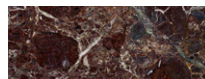

U5 Rosso Levanto
Levanto red
Levanto Rot
Rouge Levanto
Rojo Levanto

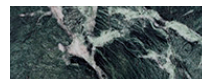

U6 Verde Saint Denis
Saint denis green
Grün Saint Denis
Vert Saint Denis
Verde Saint Denis



U7 Emperador dark
Emperador dark
Emperador dark
Emperador dark
Emperador dark

FINITURE | FINISHINGS

| OBERFLÄCHE | FINITIONS | ACABADOS

Lavabi | Washbasins | Waschbecken | Lavabos | Lavabos

Cristalplant Bio Active

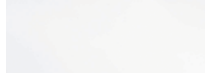

Cristalplant BIO Active base biossido di titanio. Proprietà virucide, antimicotiche e autopulenti. | Cristalplant BIO Active titanium dioxide-based. Virucidal, anti-fungal and self-cleaning properties. | Cristalplant BIO Active auf Titandioxidbasis. Viruzide, antimykotische und selbstreinigende Eigenschaften. | Cristalplant BIO Active à base de dioxyde de titane. Propriétés virucides, antifongiques et autonettoyantes. | Cristalplant BIO Active a base de dióxido de titanio. Propiedades virucidas, antifúngicas y autolimpiantes.

00 Bianco opaco

Matt white
Weiss matt
Blanc mat
Blanco mate

Cristalplant colors



IE Calcare
Limestone
Kalkstein
Calcaire
Caliza



CY Curry
Curry
Curry
Curry
Curry



B1 Biscotto
Cookie
Keks
Biscuit
Galleta



GB Ghiaia
Gravel
Kies
Gravier
Grava



OA Ombra
Shade
Schatten
Ombre
Sombra



IG Cacao
Cacao
Kakao
Cacao
Cacao



TA Terracotta
Terracotta
Terrakotta
Terre cuite
Terracota



MF Mango
Mango
Mango
Mango
Mango



JA Rosso Jaipur
Jaipur red
Jaipur Rot
Rouge Jaipur
Rojo Jaipur

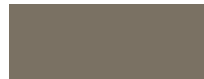

C2 Creta
Clay
Ton
Crête
Creta



TB Terra
Earth
Erde
Terre
Tierra



TM Testa di Moro
Testa di Moro
Testa di Moro
Testa di Moro
Testa di Moro

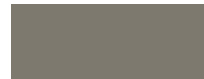

GL Grigio Londra
London grey
London Grau
Gris Londres
Gris Londres



CD Argilla
Argilla
Argilla
Argilla
Argilla



V1 Verde Comodoro
Green Commodore
Commodore Grün
Vert Comodore
Verde Comodoro



BT Blu Notte
Night blue
Nachtblau
Blue nuit
Azul noche



EY Grigio Exclusive
Exclusive grey
Exclusive Grau
Gris Exclusive
Gris Exclusive



GF Grafite
Graphite
Graphit
Graphite
Grafito



N2 Nero
Black
Schwarz
Noir
Negro

Verniciatura certificata a norma UNI-EN 14688:2018 per lo shock termico, la resistenza al graffio e alle sostanze chimiche. Avvertenza: la verniciatura inibisce le proprietà Active del Cristalplant. Ferme restano tutte le altre caratteristiche del materiale | Painting is certified for thermal shock, resistance to scratches and to chemicals according to UNI-EN 14688:2018 Warning: the painting inhibits the Active properties of Cristalplant. All the other characteristics of the material remain unchanged | Lackierung ist nach UNI-EN 14688: 2018 für Wärmeschock, Kratzfestigkeit und chemische Substanzen zertifiziert. Achtung: Der Anstrich hemmt die aktiven Eigenschaften von Cristalplant. Alle anderen Eigenschaften des Materials bleiben unverändert | Peinture certifié UNIEN 14688: 2018 pour les chocs thermiques, la résistance aux rayures et les substances chimiques. Attention : la peinture inhibe les propriétés actives de Cristalplant. Toutes les autres caractéristiques du matériau restent inchangées. | Pintura certificada según UNI-EN 14688: 2018 para choque térmico, resistencia al rayado y sustancias químicas. Advertencia: la pintura inhibe las propiedades Activas de Cristalplant. Todas las demás características del material permanecen sin cambios.

FINITURE | FINISHINGS

| OBERFLÄCHE | FINITIONS | ACABADOS

Rubinetteria

Taps | Armaturen | Robinetterie | Grifería



SP Inox spazzolato

Brushed stainless steel
Gebürstetes Edelstahl
Acier inoxydable brossé
Acero inoxidable cepillado

PM PVD Metalgun

PVD Metalgun
PVD Metalgun
PVD Metalgun
PVD Metalgun

OPTIONALS | OPTIONALS

| ZUBEHÖRE | OPTIONS | OPCIONES

LAVABO COLORATO | COLORED BASIN | FARBIGES WASCHBECKEN | VASQUE COLORÉE | LAVABO COLOREADO



Art.

STC

Optional lavabo colorato nei colori finiture lavabi - vedi pag. 21 - Verniciatura certificata a norma UNI-EN 14688:2018 per lo shock termico, la resistenza al graffio e alle sostanze chimiche. | Optional coloured basin in the washbasin colours - see page 21 - Painting is certified for thermal shock, resistance to scratches and to chemicals according to UNI-EN 14688:2018 | Option farbige Waschbecken in den Beckenfarben - siehe Seite 21 - Lackierung ist nach UNI-EN 14688: 2018 für Wärmeschock, Kratzfestigkeit und chemische Substanzen zertifiziert. | Option vasque dans les couleurs vasques - voir page 21 Peinture certifié UNI-EN 14688: 2018 pour les chocs thermiques, la résistance aux rayures et les substances chimiques. | Opcional lavabo coloreado en los acabados lavabos - ver pagina 21 - Pintura certificada según UNI-EN 14688: 2018 para choque térmico, resistencia al rayado y sustancias químicas.

Prezzo
Price

340

ILLUMINAZIONE INTERNA LED PER BASE A PARETE | INTERIOR LED LIGHTING FOR WALL UNIT | LED-INNENBELEUCHTUNG FÜR WANDBASIS | ÉCLAIRAGE INTERNE A LED POUR BASE MURALE | ILUMINACIÓN INTERIOR LED PARA BASE DE PARED



Art.

STQ

Optional lavabo colorato nei colori finiture lavabi - vedi pag. 21 - Verniciatura certificata a norma UNI-EN 14688:2018 per lo shock termico, la resistenza al graffio e alle sostanze chimiche. | Optional coloured basin in the washbasin colours - see page 21 - Painting is certified for thermal shock, resistance to scratches and to chemicals according to UNI-EN 14688:2018 | Option farbige Waschbecken in den Beckenfarben - siehe Seite 21 - Lackierung ist nach UNI-EN 14688: 2018 für Wärmeschock, Kratzfestigkeit und chemische Substanzen zertifiziert. | Option vasque dans les couleurs vasques - voir page 21 Peinture certifié UNI-EN 14688: 2018 pour les chocs thermiques, la résistance aux rayures et les substances chimiques. | Opcional lavabo coloreado en los acabados lavabos - ver pagina 21 - Pintura certificada según UNI-EN 14688: 2018 para choque térmico, resistencia al rayado y sustancias químicas.

Prezzo
Price

450

ILLUMINAZIONE INTERNA LED PER BASE FREESTANDING | INTERIOR LED LIGHTING FOR FREESTANDING UNIT | LED-INNENBELEUCHTUNG FÜR FREISTEHENDE BASIS | ÉCLAIRAGE INTERNE A LED POUR BASE FREESTANDING | ILUMINACIÓN INTERIOR LED PARA BASE FREESTANDING



Art.

STP

Optional lavabo colorato nei colori finiture lavabi - vedi pag. 21 - Verniciatura certificata a norma UNI-EN 14688:2018 per lo shock termico, la resistenza al graffio e alle sostanze chimiche. | Optional coloured basin in the washbasin colours - see page 21 - Painting is certified for thermal shock, resistance to scratches and to chemicals according to UNI-EN 14688:2018 | Option farbige Waschbecken in den Beckenfarben - siehe Seite 21 - Lackierung ist nach UNI-EN 14688: 2018 für Wärmeschock, Kratzfestigkeit und chemische Substanzen zertifiziert. | Option vasque dans les couleurs vasques - voir page 21 Peinture certifié UNI-EN 14688: 2018 pour les chocs thermiques, la résistance aux rayures et les substances chimiques. | Opcional lavabo coloreado en los acabados lavabos - ver pagina 21 - Pintura certificada según UNI-EN 14688: 2018 para choque térmico, resistencia al rayado y sustancias químicas.

Prezzo
Price

520

ACCESSORI PER CASSETTI STANDARD | ACCESSORIES FOR STANDARD DRAWERS | ZUBEHÖRE FÜR STANDARDSCHUBLADEN | ACCESSOIRES POUR TIROIRS STANDARD | ACCESORIOS PARA CAJONES ESTÁNDAR



Optional lavabo colorato nei colori finiture lavabi - vedi pag. 21 - Verniciatura certificata a norma UNI-EN 14688:2018 per lo shock termico, la resistenza al graffio e alle sostanze chimiche. | Optional coloured basin in the washbasin colours - see page 21 - Painting is certified for thermal shock, resistance to scratches and to chemicals according to UNI-EN 14688:2018 | Option farbige Waschbecken in den Beckenfarben - siehe Seite 21 - Lackierung ist nach UNI-EN 14688: 2018 für Wärmeschock, Kratzfestigkeit und chemische Substanzen zertifiziert. | Option vasque dans les couleurs vasques - voir page 21 Peinture certifié UNI-EN 14688: 2018 pour les chocs thermiques, la résistance aux rayures et les substances chimiques. | Opcional lavabo coloreado en los acabados lavabos - ver pagina 21 - Pintura certificada según UNI-EN 14688: 2018 para choque térmico, resistencia al rayado y sustancias químicas.

Per informazioni vedi pag. 357 | For information see page 357 | Für Informationen siehe S. 357 | Pour informations voir page 357 | Para informaciones véase pág. 357

BASI PER LAVABI DA APPOGGIO | BASES FOR COUNTERTOP WASHBASINS

| BASIS FÜR AUFSATZWASCHBECKEN | BASES POUR VASQUE A POSER | BASES PARA LAVABOS DE APOYO

BASE COMPLETA 1 CASSETTO CON TOP | COMPLETE UNIT WITH 1 DRAWER AND TOP | KOMPLETTER UNTERSCHRANK MIT 1 SCHUBLADE UND KONSOLENPLATTE | MODULE COMPLET AVEC 1 TIROIR ET PLAN | MÓDULO CON 1 CAJÓN Y ENCIMERA

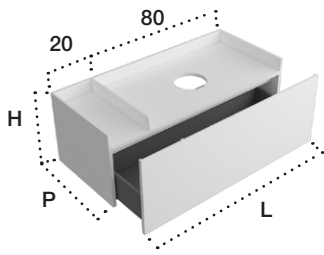

Art.	L	P	H	Cat.1	Cat.2	Cat.3
MAA DX • MAB SX	100	45	36	1.140	2.490	1.540

Versione Dx | Right Version
Rechte Version | Version Droite | Versión Derecha

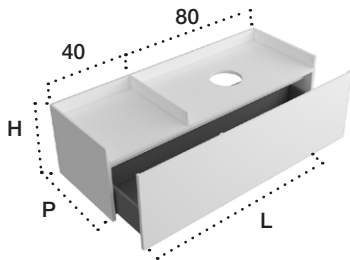

Art.	L	P	H	Cat.1	Cat.2	Cat.3
MAC DX • MAD SX	120	45	36	1.230	2.729	1.670

Versione Dx | Right Version
Rechte Version | Version Droite | Versión Derecha

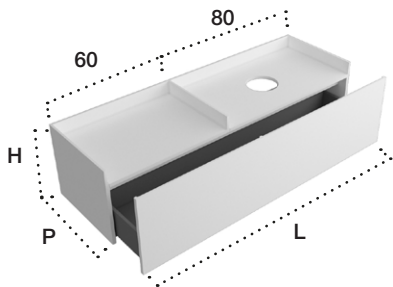

Art.	L	P	H	Cat.1	Cat.2	Cat.3
MAE DX • MAF SX	140	45	36	1.350	2.990	1.850

Versione Dx | Right Version
Rechte Version | Version Droite | Versión Derecha

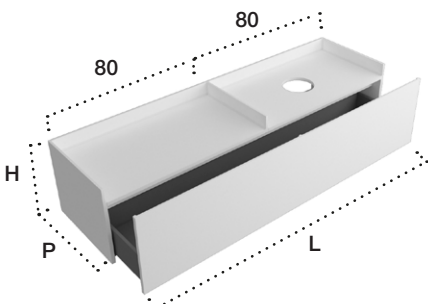

Art.	L	P	H	Cat.1	Cat.2	Cat.3
MAG DX • MAH SX	160	45	36	1.450	3.290	1.990

Versione Dx | Right Version
Rechte Version | Version Droite | Versión Derecha

BASI PER LAVABI DA APPOGGIO | BASES FOR COUNTERTOP WASHBASINS

| BASIS FÜR AUFSATZWASCHBECKEN | BASES POUR VASQUE A POSER | BASES PARA LAVABOS DE APOYO

BASE Componibile Laterale Destra 1 Cassetto con Top | Right Hand Modular Unit with 1 Drawer and Top | Modulare Basis Rechte Version, 1 Schublade und Konsolenplatte | Base Modulaire Droite avec 1 tiroir et plan | Modulo Componibile Derecho con 1 cajón y encimera

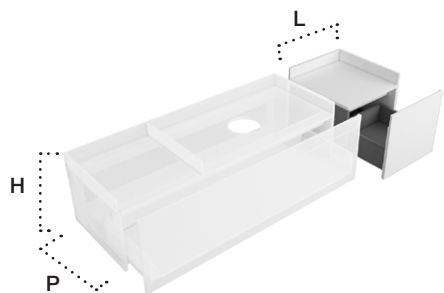

Art.	L	P	H	Cat.1	Cat.2	Cat.3
MAI 40	40	45	36	798	1.129	998
MAI 60	60			888	1.259	1.148
MAI 80	80			978	1.389	1.298

BASE Componibile Laterale Sinistra 1 Cassetto con Top | Left Hand Modular Unit with 1 Drawer and Top | Modulare Basis Linke Version, 1 Schublade und Konsolenplatte | Base Modulaire Gauche avec 1 tiroir et plan | Modulo Componibile Izquierdo con 1 cajón y encimera

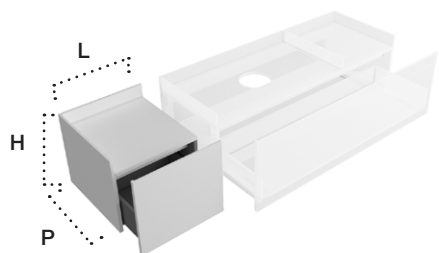

Art.	L	P	H	Cat.1	Cat.2	Cat.3
MAL 40	40	45	36	798	1.129	998
MAL 60	60			888	1.259	1.148
MAL 80	80			978	1.389	1.298

BASE Freestanding con Cassetti Laterali | Freestanding Base with Side Drawers | Freistehendes Basis mit seitlichen Schubladen | Base Freestanding avec tiroirs latéraux | Base Freestanding con cajones laterales

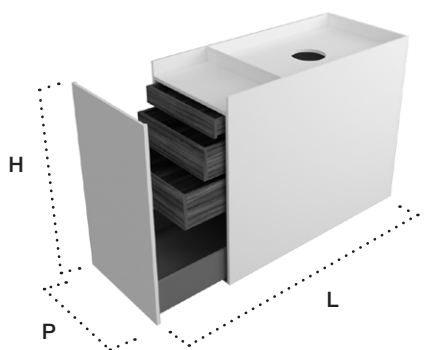

Art.	L	P	H	Cat.1	Cat.2	Cat.3
MAM	110	50	87	4.190	5.490	5.190

LAVABI DA APPOGGIO | COUNTERTOP WASHBASINS

| AUFSATZBECKEN | VASQUES À POSER | LAVABOS DE APOYO

LAVABO DA APPOGGIO PER BASE A PARETE | COUNTERTOP WASHBASIN FOR WALL UNIT | AUFSATZWASCHBECKEN FÜR WANDBASIS | VASQUES À POSER POUR BASE MURALE | LAVABOS DE APOYO PARA BASE DE PARED



Art.	L	P	Cristalplant	Marmo 1	Marmo 2
N01	80	45	1.290		
N02	80	45		4.660	
N03	80	45			5.620

Versione Dx | Right Version
Rechte Version | Version Droite | Versión Derecha

Accessori compresi | Included accessories
| Inbegriffene Zubehöre | Accessoires inclus | Accesorios incluidos

Suggeriti | Suggested
| Empfohlene | Suggérés | Sugeridos

Piletta Waste Art. 54J	Copri piletta in finitura Drain cover finish Cristalplant Marmo 1 Marmo 2	Troppo pieno Overflow No
-----------------------------	--	-------------------------------

Sifone Trap 673

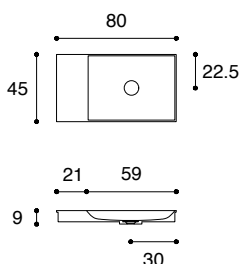

Lavabo reversibile | Reversible basin
Umkehrbares Waschbecken | Lavabo réversible | Lavabo reversible

Specificare il verso di montaggio (destra o sinistra) in fase di ordine | Indicate the assembly direction (right or left) when ordering
Geben Sie bei der Bestellung die Montagerichtung (rechts oder links) an | Spécifiez le sens de montage (droite ou gauche) lors de la commande | Especificue la dirección de montaje (derecha o izquierda) al realizar el pedido.

STC Optional lavabo colorato nei colori finiture lavabi (pag. 420) | Optional coloured basins in the washbasin colours (pg. 420) | Option farbige Waschbecken in den Beckenfarben (S. 420) | Option plan vasque dans les couleurs vasques (pag. 420) | Opcional lavabo coloreado en los acabados lavabos (pág 420)

Prezzo
Price
319

LAVABO DA APPOGGIO PER BASE A PARETE | COUNTERTOP WASHBASIN FOR WALL UNIT | AUFSATZWASCHBECKEN FÜR WANDBASIS | VASQUES À POSER POUR BASE MURALE | LAVABOS DE APOYO PARA BASE DE PARED



Art.	L	P	Cristalplant	Marmo 1	Marmo 2
N04	80	45	1.290		
N05	80	45		4.660	
N06	80	45			5.620

Versione Dx | Right Version
Rechte Version | Version Droite | Versión Derecha

Accessori compresi | Included accessories
| Inbegriffene Zubehöre | Accessoires inclus | Accesorios incluidos

Suggeriti | Suggested
| Empfohlene | Suggérés | Sugeridos

Piletta Waste Art. 54J	Copri piletta in finitura Drain cover finish Cristalplant Marmo 1 Marmo 2	Troppo pieno Overflow No
-----------------------------	--	-------------------------------

Sifone Trap 673

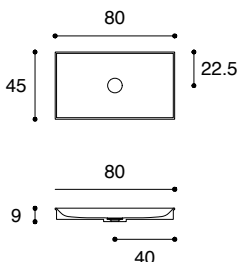

Lavabo reversibile | Reversible basin
Umkehrbares Waschbecken | Lavabo réversible | Lavabo reversible

Specificare il verso di montaggio (destra o sinistra) in fase di ordine | Indicate the assembly direction (right or left) when ordering
Geben Sie bei der Bestellung die Montagerichtung (rechts oder links) an | Spécifiez le sens de montage (droite ou gauche) lors de la commande | Especificue la dirección de montaje (derecha o izquierda) al realizar el pedido.

STC Optional lavabo colorato nei colori finiture lavabi (pag. 420) | Optional coloured basins in the washbasin colours (pg. 420) | Option farbige Waschbecken in den Beckenfarben (S. 420) | Option plan vasque dans les couleurs vasques (pag. 420) | Opcional lavabo coloreado en los acabados lavabos (pág 420)

Prezzo
Price
340

COLORE | COLOUR | FARBE | COULEUR | COLOR

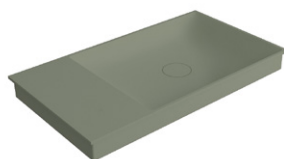

LAVABI DA APPOGGIO | COUNTERTOP WASHBASINS

| AUFSATZBECKEN | VASQUES À POSER | LAVABOS DE APOYO

LAVABO DA APPOGGIO PER BASE FREESTANDING | COUNTERTOP WASHBASIN FOR FREESTANDING UNIT | AUFSATZWASCHBECKEN FÜR FREISTEHENDE BASIS | VASQUES À POSER POUR BASE FREESTANDING | LAVABOS DE APOYO PARA BASE FREESTANDING



Art.	L	P	Cristalplant	Marmo 1	Marmo 2
N07	80	50	1.490		
N08	80	50		4.660	
N09	80	50			5.620

Versione Dx | Right Version
Rechte Version | Version Droite | Versión Derecha

Accessori compresi | Included accessories
| Inbegriffene Zubehöre | Accessoires inclus | Accesorios incluidos

Sugeriti | Suggested
| Empfohlene | Suggérés | Sugeridos

Piletta Waste	Copri piletta in finitura Drain cover finish	Troppo pieno Overflow
Art. 54J	Cristalplant Marmo 1 Marmo 2	No

Sifone Trap
673

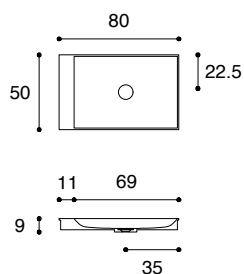

Lavabo reversibile | Reversible basin
Umkehrbares Waschbecken | Lavabo réversible | Lavabo reversible

Specificare il verso di montaggio (destra o sinistra) in fase di ordine | Indicate the assembly direction (right or left) when ordering
Geben Sie bei der Bestellung die Montagerichtung (rechts oder links) an | Spécifiez le sens de montage (droite ou gauche) lors de la commande | Especificque la dirección de montaje (derecha o izquierda) al realizar el pedido.

COLORE | COLOUR | FARBE | COULEUR | COLOR

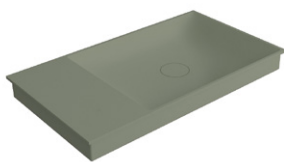

STC

Optional lavabo colorato nei colori finiture lavabi (pag. 420) | Optional coloured basins in the washbasin colours (pg. 420) | Option farbige Waschbecken in den Beckenfarben (S. 420) | Option plan vasque dans les couleurs vasques (pag. 420) | Opcional lavabo coloreado en los acabados lavabos (pág 420)

Prezzo Price 340

BOCCHE DI EROGAZIONE | SPOUTS

| AUSLAUF | BECS | CAÑOS

BOCCA DI EROGAZIONE DA PARETE CON MENSOLA | WALL MOUNTED SPOUT WITH SHELF | WANDAUSLAUF MIT ABLAGE | BEC AU MUR AVEC ÉTAGÈRE | CAÑO DE PARED CON REPISA



Art.	L	P	H	Inox	PVD
MAZ DX • MAJ SX	109,2	30,3	108,5	3.190	4.690

Bocca di erogazione da parete con mensola in marmo o legno | Wall mounted spout with marble or wooden shelf
Wandauslauf mit Ablage aus Marmor oder Holz | Bec au mur avec étagère en marbre ou en bois | Caño de pared con repisa de mármol o madera

Compatibile con comandi da parete e da piano Falper serie Acquifero | Compatible with Falper Acquifero series wall and deck mounted flow controls

Kompatibel mit Wand- und Waschtischebelmischer Acquifero-Serie von Falper | Compatible avec les commandes au mur et à poser de la série Falper Acquifero | Compatible con los mandos de pared y de repisa de la serie Acquifero de Falper

Materiale: Acciaio Aisi 316 L | Material: Steel Aisi 316 L
Material: Stahl Aisi 316 L | Matériau: Acier Aisi 316 L | Material: Acero Aisi 316 L

Versione Sx | Left Version
Linke Version | Version Gauche | Versión Izquierda

FINITURA PIANETTO | SHELF FINISHING



**LEGNI
WOODS**

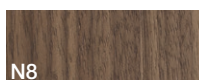

N8
Noce naturale
Natural walnut



NC
Noce Canaletto
Canaletto walnut

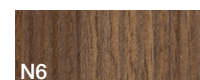

N6
Noce bruciato
Walnut burned



NW
Noce Brown
Walnut Brown



Q1
ALPI
Flamed Grey



Q8
ALPI
Striped White

FINITURA RUBINETTO | FAUCET FINISHING

**RUBINETTERIA
TAPS**

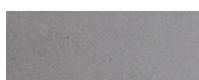

SP **Inox spazzolato**
Brushed stainless steel
Gebürstetes Edelstahl
Acier inoxydable brossé
Acero inoxidable cepillado



PM **PVD Metalgun**
PVD Metalgun
PVD Metalgun
PVD Metalgun
PVD Metalgun

BOCCHE DI EROGAZIONE | SPOUTS

| AUSLAUF | BECS | CAÑOS

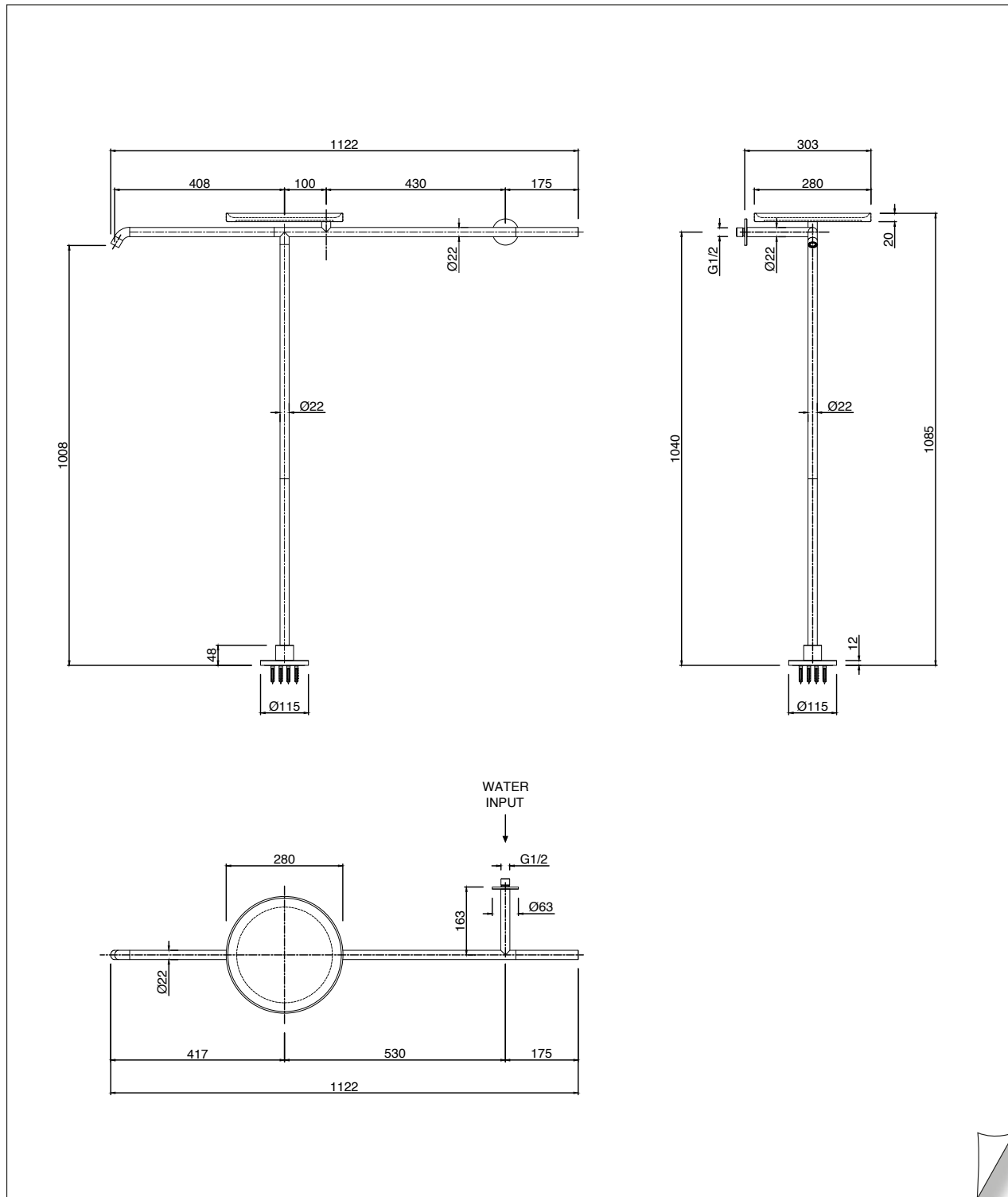

BOCCHE DI EROGAZIONE | SPOUTS

| AUSLAUF | BECS | CAÑOS

BOCCA DI EROGAZIONE DA TERRA CON MENSOLA E SPECCHIO CON ILLUMINAZIONE LED | FLOOR MOUNTED SPOUT WITH SHELF AND MIRROR WITH LED LIGHTING |
BODENSTEHENDER AUSLAUF MIT ABLAGE UND SPIEGEL MIT LEDBELEUCHTUNG | BEC AU SOL AVEC ÉTAGÈRE ET MIROIR AVEC ÉCLAIRAGE LED | CAÑO EN COLUMNA CON
REPISA Y ESPEJO CON LUZ LED



Art.	L	P	H	Inox	PVD
MAK DX • MAY SX	113,2	40,2	181,3	6.190	7.890

Bocca di erogazione da terra con mensola e specchio con illuminazione LED | Floor mounted spout with shelf and mirror with LED lighting
 Bodenstehender Auslauf mit Ablage und Spiegel mit LED-Beleuchtung | Bec au sol avec étagère et miroir avec éclairage LED | Caño en columna con repisa y espejo con luz LED

Compatibile con comandi da parete e da piano Falper serie Acquifero | Compatible with Falper Acquifero series wall and deck mounted flow controls | Kompatibel mit Wand- und Waschtischbelmischer Acquifero-Serie von Falper | Compatible avec les commandes au mur et à poser de la série Falper Acquifero | Compatible con los mandos de pared y de repisa de la serie Acquifero de Falper

Materiale: Acciaio Aisi 316 L | Material: Steel Aisi 316 L | Material: Stahl Aisi 316 L | Matériau: Acier Aisi 316 L | Material: Acero Aisi 316 L

690 Optional vetro Fumè | Option smoke grey mirror | Option Rauchgrauspiegel | Option miroir en gris fumé | Option espejo en grisigo fumo **+3%**

Versione Sx | Left Version
 Linke Version | Version Gauche
 | Versión Izquierda

FINITURA CORNICE SPECCHIO | MIRROR FRAME FINISHING

LEGNI WOODS

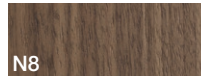

N8
Noce naturale
 Natural walnut



NC
Noce Canaletto
 Canaletto walnut

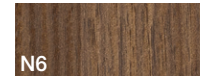

N6
Noce bruciato
 Walnut burned

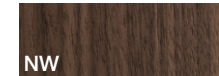

NW
Noce Brown
 Walnut Brown



Q1
ALPI
 Flamed Grey



Q8
ALPI
 Striped White

LACCATI



Realizzabile in tutte le finiture Laccate opache e lucide (Cat. 1/3).
 Feasible in all the Cat. 1/3 matt and glossy painted finishings.

FINITURA PIANETTO | SHELF FINISHING

LEGNI WOODS



N8
Noce naturale
 Natural walnut



NC
Noce Canaletto
 Canaletto walnut

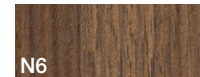

N6
Noce bruciato
 Walnut burned

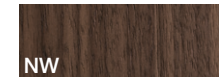

NW
Noce Brown
 Walnut Brown



Q1
ALPI
 Flamed Grey



Q8
ALPI
 Striped White

FINITURA RUBINETTO | FAUCET FINISHING

RUBINETTERIA TAPS

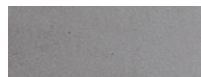

SP **Inox spazzolato**
 Brushed stainless steel
 Gebürstetes Edelstahl
 Acier inoxydable brossé
 Acero inoxidable cepillado



PM **PVD Metalgun**
 PVD Metalgun
 PVD Metalgun
 PVD Metalgun
 PVD Metalgun

BOCCHES DI EROGAZIONE | SPOUTS

| AUSLAUF | BECS | CAÑOS

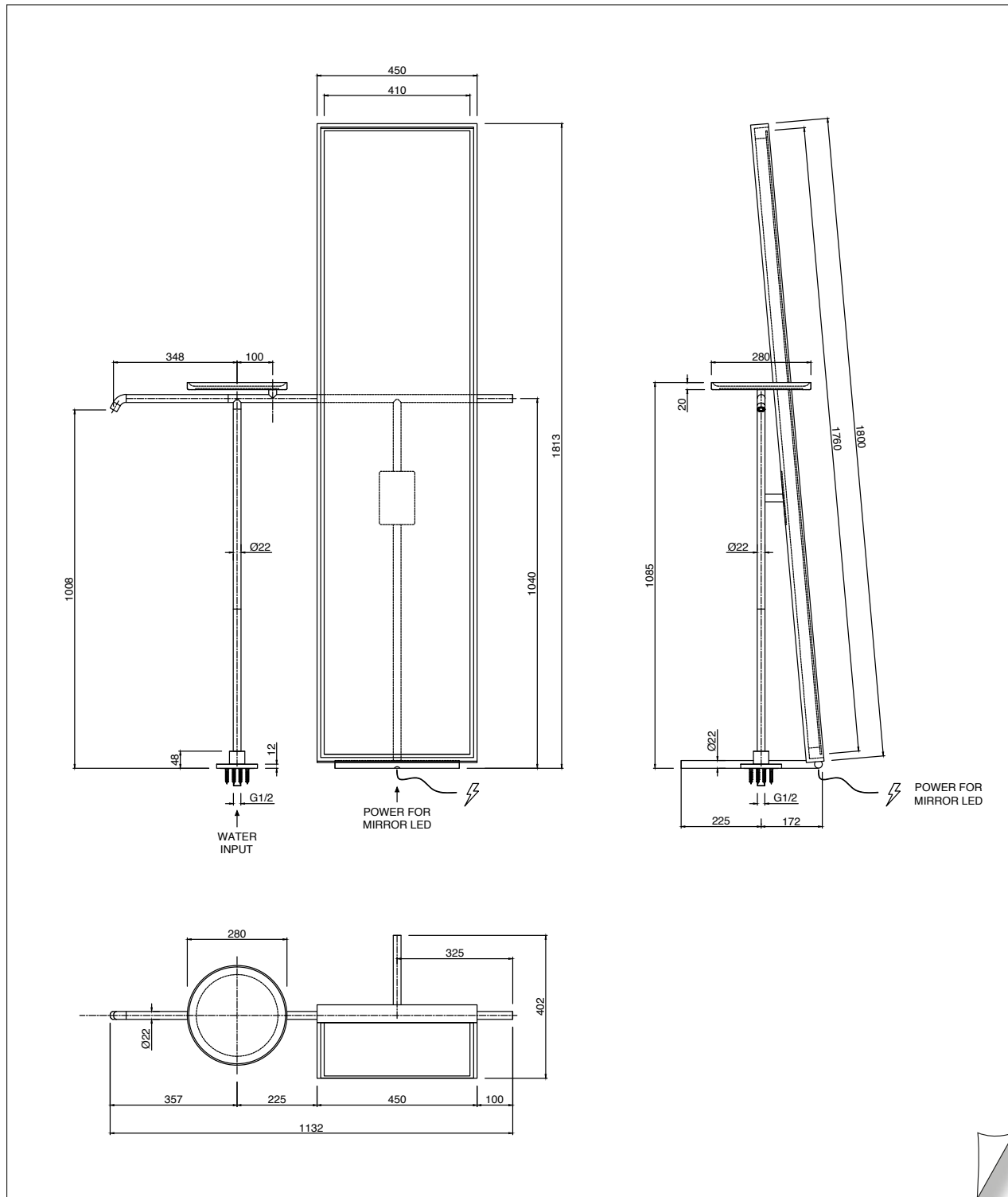



Indice della collezione Index of the collection

Com'è fatto Pag. 20
How is it made

Finiture Pag. 21
Finishings

Optionals Pag. 23
Optionals

Lavabi da terra Pag. 24
Freestanding basins



COM'È FATTO | HOW IS IT MADE

| WIE IST ES AUFGEBAUT | COMMENT EST-IL FAIT | CÓMO ESTÁ REALIZADO



1 Lavabo in Cristalplant Bio Active o marmo con copripiletta in finitura compresa nel prezzo

Washbasin in Cristalplant Bio Active or marble with drain cover in the same finish included in the price

Waschbecken aus Cristalplant Bio Active oder Marmor mit Ablaufabdeckung in der gleichen Ausführung im Preis inbegriffen

Lavabo en Cristalplant Bio Active ou en marbre avec couvercle de bonde dans la même finition inclus dans le prix

Lavabo en Cristalplant Bio Active o mármol con tapa desagüe en el mismo acabado incluido en el precio.

2 Maniglione porta salviette in acciaio inox disponibile in quattro finiture

Stainless steel towel rail available in four finishes

Handtuchhalter aus Edelstahl in vier Ausführungen erhältlich

Porte-serviettes en acier inoxydable disponible en quatre finitions

Toallero de acero inoxidable disponible en cuatro acabados

3 Basamento in legno scolpito (cesellato, fresato) disponibile in quattro finiture noce a liscio

Base in carved wood (chiseled, milled) available in four walnut finishes in the price list

Basis aus geschnitztem Holz (gemeißelt, gefräst) in vier Walnuss-Ausführungen in der Preisliste erhältlich

Base en bois sculpté (ciselé, fraisé) disponible en quatre finitions noyer dans la liste de prix

Base en madera tallada (cincelada, fresada) disponible en cuatro acabados de nogal en la lista de precios

4 Staffa per fissaggio a pavimento

Bracket for floor fixing

Halterung für Bodenbefestigung

Support de fixation au sol

Soporte de fijación al suelo

FINITURE | FINISHINGS

| OBERFLÄCHE | FINITIONS | ACABADOS

Cat. 2

Legni | Woods | Holz | Bois | Maderas

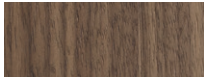

N8 Noce naturale
Natural walnut
Nussbaum Natur
Noyer naturel
Nogal naturales



NC Noce Canaletto
Canaletto walnut
Nussbaum Canaletto
Noyer Canaletto
Nogal Canaletto

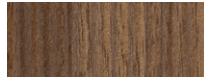

N6 Noce bruciato
Walnut burned
Nussbaum gebrannt
Noyer brûlé
Nogal quemado

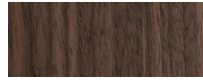

NW Noce Brown
Walnut Brown
Nussbaum braun
Noyer Foncé
Nogal marrón

Metalli

Metals | Metalle | Métaux | Metales



TI Inox Titanium
Stainless steel titanium
Edelstahl Titan
Titane en acier inoxydable
Titanio acero inoxidable



SA Inox satinato
Satin stainless steel
Satinierter Edelstahl
Acier inoxydable satiné
Acero inoxidable satinado



ON Onice
Onyx
Onyx
Onyx
Ónix



OR Ottone spazzolato
Brushed brass
Gebürstetes Messing
Laiton brossé
Latón cepillado

Lavabi | Washbasins | Waschbecken | Lavabos | Lavabos

Marmi

Marmi 1 | Marbles 1 | Marmor 1 | Marbres 1 | Marmor 1

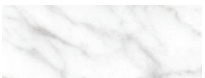

MC Carrara
Carrara
Carrara
Carrara
Carrara



MI Pietra grey
Grey Stone
Grey stone
Grauer Stein
Pierre grise



U3 Grey Saint Laurent
Saint Laurent grey
Grau Saint Laurent
Gris Saint Laurent
Gris Saint Laurent



U1 Jolie Grey
Jolie Grey
Jolie Grey
Jolie Grey
Jolie Grey

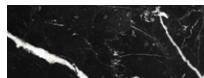

MQ Nero Marquina
Nero Marquina
Nero Marquina
Nero Marquina
Nero Marquina

Marmi 2 | Marbles 2 | Marmor 2 | Marbres 2 | Marmor 2



MR Statuario
Statuary
Statuarisch
Statuaire
Estuario



MP Calacatta Gold
Calacatta Gold
Calacatta Gold
Calacatta Gold
Calacatta Gold



U4 Arabesque Corchia
Arabesque Corchia
Arabesque Corchia
Arabesque Corchia
Arabesque Corchia

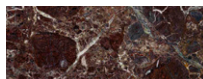

U5 Rosso Levanto
Levanto red
Levanto Rot
Rouge Levanto
Rojo Levanto

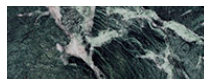

U6 Verde Saint Denis
Saint denis green
Grün Saint Denis
Vert Saint Denis
Verde Saint Denis



U7 Emperador dark
Emperador dark
Emperador dark
Emperador dark
Emperador dark

FINITURE | FINISHINGS

| OBERFLÄCHE | FINITIONS | ACABADOS

Lavabi | Washbasins | Waschbecken | Lavabos | Lavabos

Cristalplant Bio Active

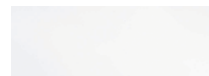

Cristalplant BIO Active base biossido di titanio. Proprietà virucide, antimicotiche e autopulenti. | Cristalplant BIO Active titanium dioxide-based. Virucidal, anti-fungal and self-cleaning properties. | Cristalplant BIO Active auf Titandioxidbasis. Viruzide, antimykotische und selbstreinigende Eigenschaften. | Cristalplant BIO Active à base de dioxyde de titane. Propriétés virucides, antifongiques et autonettoyantes. | Cristalplant BIO Active a base de dióxido de titanio. Propiedades virucidas, antifúngicas y autolimpiantes.

00 **Bianco opaco**
Matt white
Weiss matt
Blanc mat
Blanco mate

Cristalplant colors

IE Calcare Limestone Kalkstein Calcaire Caliza	CY Curry Curry Curry Curry Curry	B1 Biscotto Cookie Keks Biscuit Galleta	GB Ghiaia Gravel Kies Gravier Grava	OA Ombra Shade Schatten Ombre Sombra	IG Cacao Cacao Kakao Cacao Cacao	TA Terracotta Terracotta Terrakotta Terre cuite Terracota
MF Mango Mango Mango Mango Mango	JA Rosso Jaipur Jaipur red Jaipur Rot Rouge Jaipur Rojo Jaipur	C2 Creta Clay Ton Crête Creta	TB Terra Earth Erde Terre Tierra	TM Testa di Moro Testa di Moro Testa di Moro Testa di Moro Testa di Moro	GL Grigio Londra London grey London Grau Gris Londres Gris Londres	CD Argilla Argilla Argilla Argilla Argilla
V1 Verde Comodoro Green Comodore Commodore Grün Vert Comodore Verde Comodoro	BT Blu Notte Night blue Nachtblau Blue nuit Azul noche	EY Grigio Exclusive Exclusive grey Exclusive Grau Gris Exclusive Gris Exclusive	GF Grafite Graphite Graphit Graphite Grafito	N2 Nero Black Schwarz Noir Negro		

Verniciatura certificata a norma UNI-EN 14688:2018 per lo shock termico, la resistenza al graffio e alle sostanze chimiche. Avvertenza: la verniciatura inibisce le proprietà Active del Cristalplant. Ferme restano tutte le altre caratteristiche del materiale | Painting is certified for thermal shock, resistance to scratches and to chemicals according to UNI-EN 14688:2018 Warning: the painting inhibits the Active properties of Cristalplant. All the other characteristics of the material remain unchanged | Lackierung ist nach UNI-EN 14688: 2018 für Wärmeschock, Kratzfestigkeit und chemische Substanzen zertifiziert. Achtung: Der Anstrich hemmt die aktiven Eigenschaften von Cristalplant. Alle anderen Eigenschaften des Materials bleiben unverändert | Peinture certifié UNIEN 14688: 2018 pour les chocs thermiques, la résistance aux rayures et les substances chimiques. Attention : la peinture inhibe les propriétés actives de Cristalplant. Toutes les autres caractéristiques du matériau restent inchangées. | Pintura certificada según UNI-EN 14688: 2018 para choque térmico, resistencia al rayado y sustancias químicas. Advertencia: la pintura inhibe las propiedades Activas de Cristalplant. Todas las demás características del material permanecen sin cambios.

OPTIONALS | OPTIONALS

| ZUBEHÖRE | OPTIONS | OPCIONES

LAVABO COLORATO | COLORED BASIN | FARBIGES WASCHBECKEN | VASQUE COLORÉE | LAVABO COLOREADO



Art.

STC

Prezzo
Price

340

Optional lavabo colorato nei colori finiture lavabi - vedi pag. 21 - Verniciatura certificata a norma UNI-EN 14688:2018 per lo shock termico, la resistenza al graffio e alle sostanze chimiche. | Optional coloured basin in the washbasin colours - see page 21 - Painting is certified for thermal shock, resistance to scratches and to chemicals according to UNI-EN 14688:2018 | Option farbige Waschbecken in den Beckenfarben - siehe Seite 21 - Lackierung ist nach UNI-EN 14688: 2018 für Wärmeschock, Kratzfestigkeit und chemische Substanzen zertifiziert. | Option vasque dans les couleurs vasques - voir page 21 Peinture certifié UNI-EN 14688: 2018 pour les chocs thermiques, la résistance aux rayures et les substances chimiques. | Opcional lavabo coloreado en los acabados lavabos - ver pagina 21 - Pintura certificada según UNI-EN 14688: 2018 para choque térmico, resistencia al rayado y sustancias químicas.

LAVABI DA TERRA | FREESTANDING BASINS

| FREISTEHENDE WASCHBECKEN | LAVABOS À COLONNE | LAVABO EN COLUMNA

LAVABO FREESTANDING IN CRISTALPLANT BIO ACTIVE E LEGNO CANNETTATO | CRISTALPLANT BIO ACTIVE AND STRIPED WOOD FREESTANDING WASHBASIN | FREISTEHENDES WASCHBECKEN AUS CRISTALPLANT BIO ACTIVE UND GESTREIFTES HOLZ | LAVABO SUR PIED EN CRISTALPLANT BIO ACTIVE ET BOIS RAYÉ | LAVABO FREESTANDING EN CRISTALPLANT BIO ACTIVE Y MADERA RAYADA

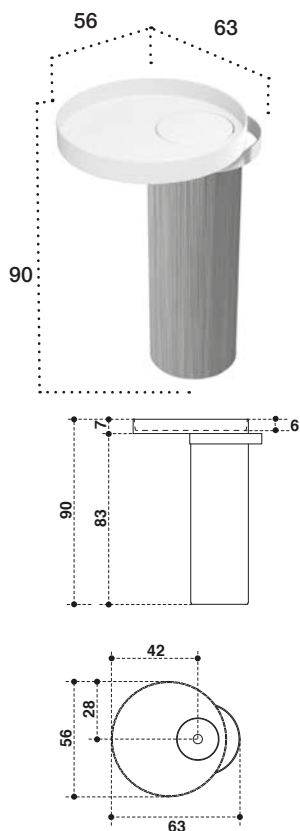

Art.	L	P	H	Cat.2
WM5	63	56	90	4.490

Accessori compresi | Included accessories
| Inbegriffene Zubehöre | Accessoires inclus | Accesorios incluidos

Piletta Waste Art. 56G	Copri piletta in finitura Drain cover finish Cristalplant Bio Active	Troppo pieno Overflow No	Sifone Trap 52G Incluso Included
-----------------------------	---	-------------------------------	---

Indicare le finiture del porta salviette e del basamento. | Specify the finish of the towel bar and base. | Die gewünschte Farbe des Handtuchhalters und Säule angeben. | Spécifier la finition du porte-serviette et de la base. | Especificar el acabado del porta pañuelos y base.

FINITURE PORTA SALVIETTE | TOWEL BAR FINISHINGS | OBERFLÄCHE DES HANDTUCHHALTERS | FINITION DU PORTE-SERVIETTE | ACABADOS DEL SUPORTE PORTA PAÑUELOS

METALLI METALS



Inox Titanium
Stainless steel titanium



Inox satinato
Satin stainless steel



Onice
Onyx



Ottone spazzolato
Brushed brass

FINITURE BASAMENTO | BASE FINISHINGS | OBERFLÄCHE DER SÄULE | FINITION DE LA BASE | ACABADOS BASE

LEGNI WOODS

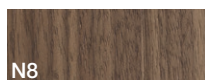

Noce naturale
Natural walnut



Noce Canaletto
Canaletto walnut



Noce bruciato
Walnut burned



Noce Brown
Walnut Brown

COLORE | COLOUR | FARBE | COULEUR | COLOR



STC

Optional lavabo colorato nei colori finiture lavabi (pag. 420) | Optional coloured basins in the washbasin colours (pg. 420) | Option farbige Waschbecken in den Beckenfarben (S. 420) | Option plan vasque dans les couleurs vasques (pag. 420) | Opcional lavabo coloreado en los acabados lavabos (pág 420)

Prezzo
Price
340

LAVABI DA TERRA | FREESTANDING BASINS

| FREISTEHENDE WASHBECKEN | LAVABOS À COLONNE | LAVABO EN COLUMNA

LAVABO FREESTANDING IN MARMO E LEGNO CANNETTATO | MARBLE AND STRIPED WOOD FREESTANDING WASHBASIN | FREISTEHENDES WASHBECKEN AUS MARMOR UND GESTREIFTES HOLZ | LAVABO SUR PIED EN MARBRE ET BOIS RAYÉ | LAVABO FREESTANDING EN MÁRMOL Y MADERA RAYADA

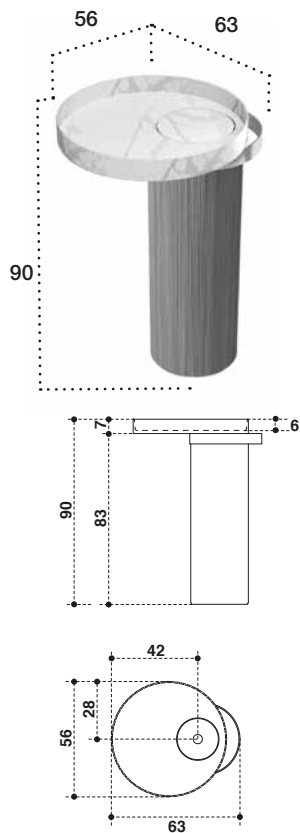

Art.	L	P	H	Marmo 1 Marble 1	Marmo 2 Marble 2
WM7	63	56	90	6.980	7.980

Accessori compresi | Included accessories
| Inbegriffene Zubehöre | Accessoires inclus | Accesorios incluidos

Piletta Waste	Copri piletta in finitura Drain cover finish	Troppo pieno Overflow	Sifone Trap
Art. 56G	Marmo Marble	No	52G Incluso Included

Indicare le finiture del lavabo, del porta salviette e del basamento. | Specify the finish of the towel bar, basin and base. | Die gewünschte Farbe des Handtuchhalters, Waschbeckens und Säule angeben | Spécifier la finition du lavabo, du porte-serviette et de la base. | Especificar el acabado del porta pañuelos, lavabo y base.

FINITURE LAVABO | BASIN FINISHINGS | OBERFLÄCHE DES WASHBECKENS | FINITION DU LAVABO | ACABADOS DE LAVABO

MARMI 1 * MARBLES 1



MC
Carrara
Carrara



MI
Pietra Grey
Grey stone



U3
Grey Saint Laurent
Saint Laurent grey



U1
Jolie Grey
Jolie Grey

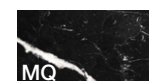

MQ
Nero Marquinia
Nero Marquinia

* Marmi in finitura satinata opaca. | Marble feasible in satin matt finish.

| Marmor in satiniert matten Ausführung | Marbre en finition matte satinée. | Mármol en un acabado mate satinado.

MARMI 2 MARBLES 2



MR
Statuario
Statuary



MP
Calacatta Gold
Calacatta Gold



U4
Arabescato Corchia
Arabesque Corchia

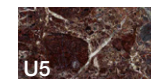

U5
Rosso Levante
Levanto red



U6
Verde Saint Denis
Saint denis green



U7
Emperador dark
Emperador dark

FINITURE PORTA SALVIETTE | TOWEL BAR FINISHINGS | OBERFLÄCHE DES HANDTUCHHALTERS | FINITION DU PORTE-SERVIETTE | ACABADOS DEL SUPORTE PORTA PAÑUELOS

METALLI METALS

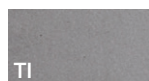

TI
Inox Titanium
Stainless steel titanium

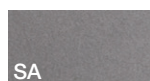

SA
Inox satinato
Satin stainless steel



ON
Onice
Onyx



OR
Ottone spazzolato
Brushed brass

FINITURE BASAMENTO | BASE FINISHINGS | OBERFLÄCHE DER SÄULE | FINITION DE LA BASE | ACABADOS BASE

LEGNI WOODS



N8
Noce naturale
Natural walnut



NC
Noce Canaletto
Canaletto walnut



N6
Noce bruciato
Walnut burned



NW
Noce Brown
Walnut Brown

SPECCHI CON ILLUMINAZIONE | MIRRORS WITH LIGHTING

| SPIEGEL MIT BELEUCHTUNG | MIROIRS AVEC ÉCLAIRAGE | ESPEJOS CON LUZ

SPECCHIO CIRCOLARE RETROILLUMINATO LED | CIRCULAR MIRROR WITH BACK LED LIGHTNING | RUNDSPIEGEL MIT LED HINTERBELEUCHTUNG | MIROIR CIRCULAIRE AVEC RETROÉCLAIRAGE LED | ESPEJO CIRCULAR CON RETROILUMINACION LED

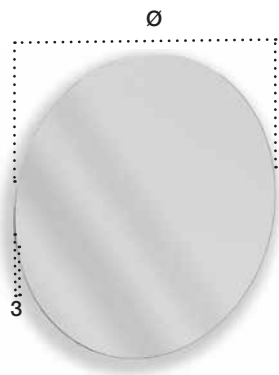

Art.	L	P	Prezzo Price
6T9 150	Ø 150	3	1.596



Struttura in materiale composito
Composite material structure
Gestell aus Mischmaterial
Structure en matériel composite
Estructura de material compuesto

Retro illuminazione perimetrale a LED con trasformatore. 220/240V - 12W | Perimetral led backlighting with transformer 220/240V - 12W | Led-Hintergrundbeleuchtung mit Trafo 220/240V - 12W | Rétroillumination à Leds du périmètre avec transformateur 220/240V - 12W | Retroiluminación perimetral Led con transformador 220/240 V - 12W

690 Optional vetro Fumè | Option smoke grey mirror | Option Rauchgrauspiegel | Option miroir en gris fumé | Option espejo en grigio fumo +15%

IP20



MINIMUM LAVABI

Design Victor Vasilev



Indice della collezione Index of the collection

Finiture Pag. 318
Finishings

Optionals Pag. 323
Optionals

Lavabi Pag. 341
Washbasins



FINITURE | FINISHINGS

| OBERFLÄCHE | FINITIONS | ACABADOS

Lavabi | Washbasins | Waschbecken | Lavabos | Lavabos

Cristalplant Bio Active

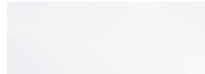

Cristalplant BIO Active base biossido di titanio. Proprietà virucide, antimicotiche e autopulenti. | Cristalplant BIO Active titanium dioxide-based. Virucidal, anti-fungal and self-cleaning properties. | Cristalplant BIO Active auf Titandioxidbasis. Viruzide, antimykotische und selbstreinigende Eigenschaften. | Cristalplant BIO Active à base de dioxyde de titane. Propriétés virucides, antifongiques et autonettoyantes. | Cristalplant BIO Active a base de dióxido de titanio. Propiedades virucidas, antifúngicas y autolimpiantes.

00 Bianco opaco
Matt white
Weiss matt
Blanc mat
Blanco mate

Cristalplant colors

IE Calcare Limestone Kalkstein Calcaire Caliza	CY Curry Curry Curry Curry Curry	B1 Biscotto Cookie Keks Biscuit Galleta	GB Ghiaia Gravel Kies Gravier Grava	OA Ombra Shade Schatten Ombre Sombra	IG Cacao Cacao Kakao Cacao Cacao	TA Terracotta Terracotta Terrakotta Terre cuite Terracota
MF Mango Mango Mango Mango Mango	JA Rosso Jaipur Jaipur red Jaipur Rot Rouge Jaipur Rojo Jaipur	C2 Creta Clay Ton Crête Creta	TB Terra Earth Erde Terre Tierra	TM Testa di Moro Testa di Moro Testa di Moro Testa di Moro Testa di Moro	GL Grigio Londra London grey London Grau Gris Londres Gris Londres	CD Argilla Argilla Argilla Argila Argilla
V1 Verde Comodoro Green Commodore Commodore Grün Vert Commodore Verde Comodoro	BT Blu Notte Night blue Nachtblau Blue nuit Azul noche	EY Grigio Exclusive Exclusive grey Exclusive Grau Gris Exclusive Gris Exclusive	GF Grafite Graphite Graphit Graphite Grafito	N2 Nero Black Schwarz Noir Negro		

Verniciatura certificata a norma UNI-EN 14688:2018 per lo shock termico, la resistenza al graffio e alle sostanze chimiche. Avvertenza: la verniciatura inibisce le proprietà Active del Cristalplant. Ferme restano tutte le altre caratteristiche del materiale | Painting is certified for thermal shock, resistance to scratches and to chemicals according to UNI-EN 14688:2018 Warning: the painting inhibits the Active properties of Cristalplant. All the other characteristics of the material remain unchanged | Lackierung ist nach UNI-EN 14688: 2018 für Wärmeschock, Kratzfestigkeit und chemische Substanzen zertifiziert. Achtung: Der Anstrich hemmt die aktiven Eigenschaften von Cristalplant. Alle anderen Eigenschaften des Materials bleiben unverändert | Peinture certifié UNIEN 14688: 2018 pour les chocs thermiques, la résistance aux rayures et les substances chimiques. Attention : la peinture inhibe les propriétés actives de Cristalplant. Toutes les autres caractéristiques du matériau restent inchangées. | Pintura certificada según UNI-EN 14688: 2018 para choque térmico, resistencia al rayado y sustancias químicas. Advertencia: la pintura inhibe las propiedades Activas de Cristalplant. Todas las demás características del material permanecen sin cambios.

OPTIONALS | OPTIONALS

| ZUBEHÖRE | OPTIONS | OPCIONES

LAVABO COLORATO | COLORED BASIN | FARBIGES WASCHBECKEN | VASQUE COLORÉE | LAVABO COLOREADO



Art.

STC

**Prezzo
Price**

340

Optional lavabo colorato nei colori finiture lavabi - vedi pag. 21 - Verniciatura certificata a norma UNI-EN 14688:2018 per lo shock termico, la resistenza al graffio e alle sostanze chimiche. | Optional coloured basin in the washbasin colours - see page 21 - Painting is certified for thermal shock, resistance to scratches and to chemicals according to UNI-EN 14688:2018 | Option farbige Waschbecken in den Beckenfarben - siehe Seite 21 - Lackierung ist nach UNI-EN 14688: 2018 für Wärmeschock, Kratzfestigkeit und chemische Substanzen zertifiziert. | Option vasque dans les couleurs vasques - voir page 21 Peinture certifié UNI-EN 14688: 2018 pour les chocs thermiques, la résistance aux rayures et les substances chimiques. | Opcional lavabo coloreado en los acabados lavabos - ver pagina 21 - Pintura certificada según UNI-EN 14688: 2018 para choque térmico, resistencia al rayado y sustancias químicas.

LAVABI | WASHBASINS

| BECKEN | VASQUES | LAVABOS

H 36

LAVABO A PARETE | WALL-MOUNTED WASHBASIN | WANDWASCHBECKEN | LAVABO AU MUR | LAVABO A PARED

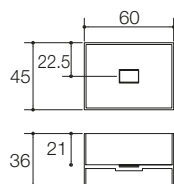
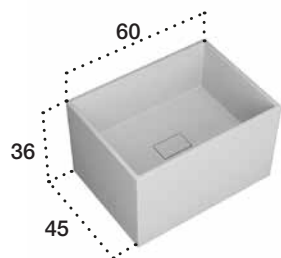

Art.	L	P	H	Cristalplant
N11	60	45	36	2.690

Accessori compresi | Included accessories
| Inbegriffene Zubehöre | Accessoires inclus | Accesorios incluidos

Piletta Waste Art. 56A	Copri piletta in finitura Drain cover finish Cristalplant Bio Active	Troppo pieno Overflow No
------------------------------------	--	--------------------------------------

Suggeriti | Suggested
| Empfohlene | Suggérés | Sugeridos

Sifone Trap 673

STC	Optional lavabo colorato nei colori finiture lavabi (pag. 420) Optional coloured basins in the washbasin colours (pg. 420) Option farbige Waschbecken in den Beckenfarben (S. 420) Option plan vasque dans les couleurs vasques (pag. 420) Opcional lavabo coloreado en los acabados lavabos (pág 420)	Prezzo Price 319
------------	--	-----------------------------------

LAVABO A PARETE CON MENSOLA | WALL -MOUNTED WASHBASIN WITH SHELF | WANDWASCHBECKEN MIT ABLAGE | LAVABO AU MUR AVEC PLAGE | LAVABO A PARED CON REPISA

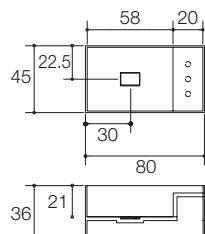
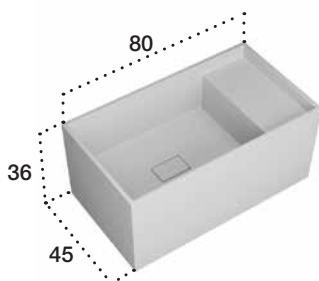

Art.	L	P	H	Cristalplant
N21 DX • N22 SX	80	45	36	3.180

Accessori compresi | Included accessories
| Inbegriffene Zubehöre | Accessoires inclus | Accesorios incluidos

Piletta Waste Art. 56A	Copri piletta in finitura Drain cover finish Cristalplant Bio Active	Troppo pieno Overflow No
------------------------------------	--	--------------------------------------

Suggeriti | Suggested
| Empfohlene | Suggérés | Sugeridos

Sifone Trap 673

Versione Sx | Left Version
Linke Version | Version Gauche
Versión Izquierda

COLORE | COLOUR | FARBE | COULEUR | COLOR

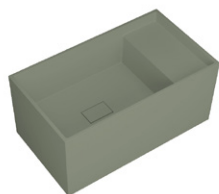

STC	Optional lavabo colorato nei colori finiture lavabi (pag. 420) Optional coloured basins in the washbasin colours (pg. 420) Option farbige Waschbecken in den Beckenfarben (S. 420) Option plan vasque dans les couleurs vasques (pag. 420) Opcional lavabo coloreado en los acabados lavabos (pág 420)	Prezzo Price 340
------------	--	-----------------------------------

Lavabi comprensivi di staffa in metallo per fissaggio a parete | The washbasin include the brackets for wall-mounting | Die Abstützbügel für Wandmontage sind in Lieferumfang der Becken inbegriffen | Lavabos avec supports en métal pour montage au mur inclus | Los soportes para el montaje a la pared están incluido en los lavabos

Compresa
Included

LAVABI | WASHBASINS

| BECKEN | VASQUES | LAVABOS

H 25

LAVABO A PARETE CON MENSOLA | WALL -MOUNTED WASHBASIN WITH SHELF | WANDWASCHBECKEN MIT ABLAGE | LAVABO AU MUR AVEC PLAGE | LAVABO A PARED CON REPISA

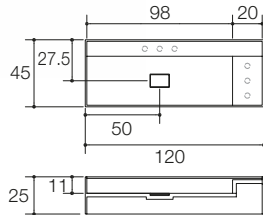
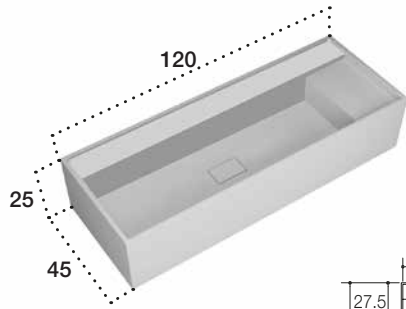

Art.

L P H

Cristalplant

N32 SX

120 45 25

2.980

Accessori compresi | Included accessories
| Inbegriffene Zubehöre | Accessoires inclus | Accesorios incluidos

Piletta Waste	Copri piletta in finitura Drain cover finish	Troppo pieno Overflow
Art. 56A	Cristalplant Bio Active	No

Suggeriti | Suggested
| Empfohlene | Suggérés | Sugeridos

Sifone Trap
673

COLORE | COLOUR | FARBE | COULEUR | COLOR

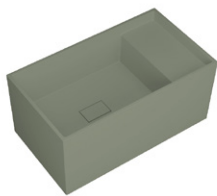

STC

Optional lavabo colorato nei colori finiture lavabi (pag. 420) | Optional coloured basins in the washbasin colours (pg. 420) | Option farbige Waschbecken in den Beckenfarben (S. 420) | Option plan vasque dans les couleurs vasques (pag. 420) | Opcional lavabo coloreado en los acabados lavabos (pág 420)

Prezzo
Price

340

Lavabi comprensivi di staffa in metallo per fissaggio a parete | The washbasin include the brackets for wall-mounting | Die Abstützbügel für Wandmontage sind in Lieferumfang der Becken inbegriffen | Lavabos avec supports en métal pour montage au mur inclus | Los soportes para el montaje a la pared están incluido en los lavabos

Compresa
Included

ACCESSORI CILINDRO | CILINDRO ACCESSORIES

| CILINDRO ZUBEHÖRE | ACCESSOIRES CILINDRO | OPCIONALES CILINDRO



FINITURE | FINISHINGS

| OBERFLÄCHE | FINITIONS | ACABADOS



SP Inox spazzolato

Brushed stainless steel
Gebürstetes Edelstahl
Acier inoxydable brossé
Acero inoxidable cepillado

SQ Inox spazzolato | Nero

Brushed stainless steel|Matt black
Gebürstetes Edelstahl|Schwarz matt
Acier inoxydable brossé|Noir mat
Acero inoxidable cepillado|Negro mate

ACCESSORI CILINDRO | CILINDRO ACCESSORIES

| CILINDRO ZUBEHÖRE | ACCESSOIRES CILINDRO | OPCIONALES CILINDRO

PORTA SALVIETTE A PARETE | WALL TOWEL BAR | WANDHANDTUCHHALTER | PORTE-SERVIETTE AU MUR | TOALLERO A PARED



Art.	L	P	Inox spazzolato Brushed stainless steel	Inox spazzolato nero opaco Brushed stainless steel matt black
GXB	40	10,4	250	260

Materiale: Acciaio Inox | Material: Steel | Material: Stahl | Matériau: Acier | Material: Acero

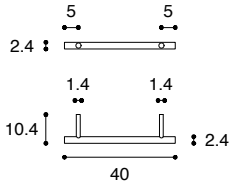

GANCIO PORTA ASCIUGAMANI A PARETE | WALL HOOK | WANDHANDTUCHHAKEN | CROCHET SERVIETTE AU MUR | GANCHO PARA TOALLAS DE PARED



Art.	L	P	Inox spazzolato Brushed stainless steel	Inox spazzolato nero opaco Brushed stainless steel matt black
GXC	4,5	5,6	159	169

Materiale: Acciaio Inox | Material: Steel | Material: Stahl | Matériau: Acier | Material: Acero

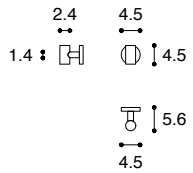

ACCESSORI CILINDRO | CILINDRO ACCESSORIES

| CILINDRO ZUBEHÖRE | ACCESSOIRES CILINDRO | OPCIONALES CILINDRO

PORTAROTOLO A PARETE | WALL ROLL HOLDER | WANDROLLENHALTER | PORTE-ROULEAU MURAL | PORTAROLLO DE PARED



Art.	L	P	Inox spazzolato Brushed stainless steel	Inox spazzolato nero opaco Brushed stainless steel matt black
GXD	15,5	8,2	198	210

Materiale: Acciaio Inox | Material: Steel | Material: Stahl | Matériau: Acier | Material: Acero

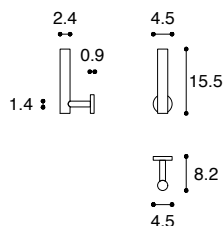

Falper srl

Via Veneto 7 – 9
40064 Ozzano Emilia, Bologna (Italy)

Tel + 39 051 799319

Fax + 39 051 796495

info@falper.it – www.falper.it