

SALONE 2024 DESIGN BOOK

Embark on a journey of **timeless elegance** with Falper's latest unveilings at Salone 2024. Introducing the expanded **Viaveneto** collection with **Classic and Frame editions**, alongside **Senzafine** and **Ognidove** collections. **Eccentrico Rigatino**, now available on the cabinet. The **MA Elements** collection, designed to be bespoke. New **mirrors**, **washbasins**, the **Sorgente** freestanding basin and new finishes in faucet range. Explore the **4.0** with vibrant new color combinations and **Butler** with wooden shelves. Finally, don't miss **SLK Project**, designed to elevate kitchens projects with versatile color options. In this fusion of innovation and craftsmanship, Falper always **shines as a beacon of distinction.**

falper.

Index.

INTRO	04
VIAVENETO CLASSICA	16
<i>Circolo</i>	24
VIAVENETO FRAME	42
<i>Invaso</i>	50
VIAVENETO SISTEMA GUARDAROBA	56
<i>Glacette</i>	62
SENZAFINE	66
<i>Onda</i>	74
<i>Cala Fluida</i>	86
OGNIDOVE	92
<i>Sorgente</i>	100
DON'T MIND THE KITCHENS	110
MA	120
<i>MA Elements</i>	128
BUTLER WOOD	148
ECCENTRICO RIGATINO	154
QUATTRO.ZERO	168
SMALL LIVING KITCHENS PROJECT COLLECTION	180

L

O

V

E

falper.

ESSENCE

falper.

BALANCE

falper.

UNIQUENESS

falper.

falper.

YOU

LOVE

by Pietro Terzini.

Pietro Terzini, un artista contemporaneo di fama internazionale, le cui opere hanno definito i valori di alcuni dei principali brand di moda internazionali, tra cui Hermes, Tiffany, Gucci, Moncler e Bottega Veneta. L'opera d'arte, appositamente concepita per Falper, è un'installazione urbana che celebra i valori del marchio, invitando il pubblico a riflettere sull'importanza dell'amore per l'arte, il design e la creatività nel mondo contemporaneo.

Pietro Terzini, a contemporary artist of international renown, whose works have defined the values of some of the main international fashion brands, including Hermes, Tiffany, Gucci, Moncler, and Bottega Veneta. The artwork, specially conceived for Falper, is an urban installation that celebrates the brand's values, inviting the public to reflect on the importance of love for art, design, and creativity in the contemporary world.



LOVE

by Pietro Terzini

" Nel concepire l'installazione "LOVE" per Falper, mi sono lasciato ispirare dal mio primo incontro nel loro showroom, dove l'ambiente mi ha avvolto con la sua essenza e unicità. Falper incarna per me i valori fondamentali di eccellenza, innovazione e passione per il design. Con questa opera urbana, ho voluto trasmettere proprio un invito alla riflessione sull'importanza dell'amore per l'arte, il design e la creatività, usando come ispirazione i valori cardine del Brand. "

" In conceiving the "LOVE" installation for Falper, I drew inspiration from my first encounter in their showroom, where the environment enveloped me with its essence and uniqueness. Falper embodies for me the fundamental values of excellence, innovation, and passion for design. With this urban artwork, I aimed to convey an invitation to reflect on the importance of love for art, design, and creativity, drawing inspiration from the Brand's core values. "



U
S

UNIQUENESS

Il mondo di *Falper.*

Nel mondo di Falper, eleganza, equilibrio e originalità convergono in una sinfonia unica. Ogni prodotto e allestimento riflette uno stile di vita dove la semplificazione è una raffinata sofisticazione. I nostri ambienti raccontano una bellezza senza tempo, da contemplare e da vivere ogni giorno, traendo ristoro e beneficio dal piacere estetico e dalla eccellenza dei dettagli che influenzino positivamente l'esperienza quotidiana.

In the world of Falper, elegance, balance, and originality converge in a unique symphony. Each product and setting reflects a lifestyle where simplification is refined sophistication. Our environments narrate a timeless beauty to contemplate and experience every day, drawing refreshment and benefit from aesthetic pleasure and excellence in details that positively influence the daily experience.



ESSENCE



Falper *design*

Il cuore pulsante di Falper risiede nel suo team multidisciplinare di architetti, designer, tecnici e creativi. Insieme, danno vita a collezioni di arredi e oggetti che rappresentano il nostro stile distintivo. La nostra filosofia di design si traduce in forme pulite, funzionalità innovativa e una raffinata estetica contemporanea. Un nuovo modo di vivere lo spazio, dove ogni dettaglio è pensato per ispirare e stupire.

The beating heart of Falper resides in its multidisciplinary team of architects, designers, technicians, and creatives. Together, they give life to collections of furnishings and objects that represent our distinctive style. Our design philosophy translates into clean lines, innovative functionality, and refined contemporary aesthetics. A new way of living in space, where every detail is designed to inspire and amaze.

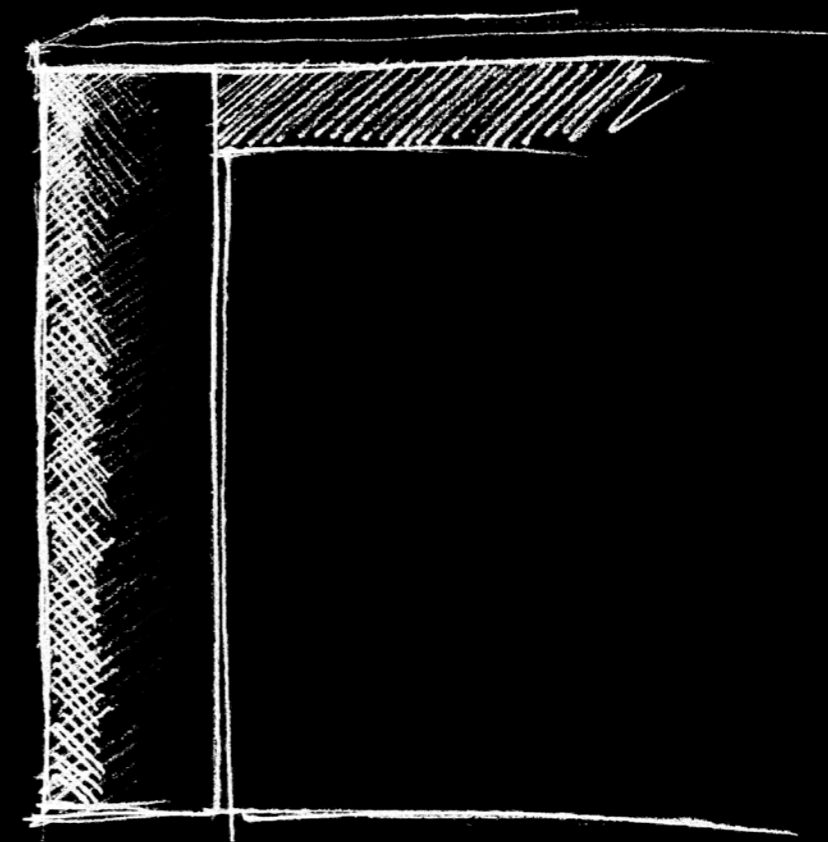

Viaveneto *classica*

L'iconica collezione Falper prende vita in una nuova veste classic, con fianchi laterali curvi e un raffinato bordo bisellato dei top. Questa rivisitazione porta lo stile essenziale e sofisticato di Falper in ambienti più classici, offrendo un connubio tra tradizione e modernità senza precedenti. Benvenuti nell'eleganza senza tempo di Viaveneto Classica.

The iconic Falper collection comes to life in a new classic guise, with curved side panels and a refined beveled edge on the tops. This reinterpretation brings Falper's essential and sophisticated style into more classic environments, offering an unprecedented blend of tradition and modernity. Welcome to the timeless elegance of Viaveneto Classica.



Viaveneto Classica

Falper celebra l'iconica Collezione **Viaveneto** by **Falper Design** con un'evoluzione studiata per rispondere alle esigenze di un gusto più tradizionale e che si caratterizza per forme più morbide, pur mantenendo l'elegante rigore e le proporzioni che contraddistinguono il design Falper. La collezione si distingue per l'introduzione di piani in marmo bisellati, fianchi arrotondati, una nuova gamma di specchi e nuovi lavabi da appoggio, fornendo un tocco di raffinatezza e unicità. Questa combinazione di elementi conferisce agli spazi bagno un'aura di classicità intramontabile, arricchita da dettagli moderni e sofisticati.

Falper celebrates the iconic **Viaveneto Collection** by **Falper Design** with an evolution designed to meet the needs of a more traditional taste, characterized by softer forms while maintaining the elegant rigor and proportions that define Falper design. The collection stands out with the introduction of beveled marble countertops, rounded sides, a new range of mirrors, and new countertop sinks, providing a touch of refinement and uniqueness. This combination of elements lends timeless classic sophistication to bathroom spaces, enriched by modern and sophisticated details.



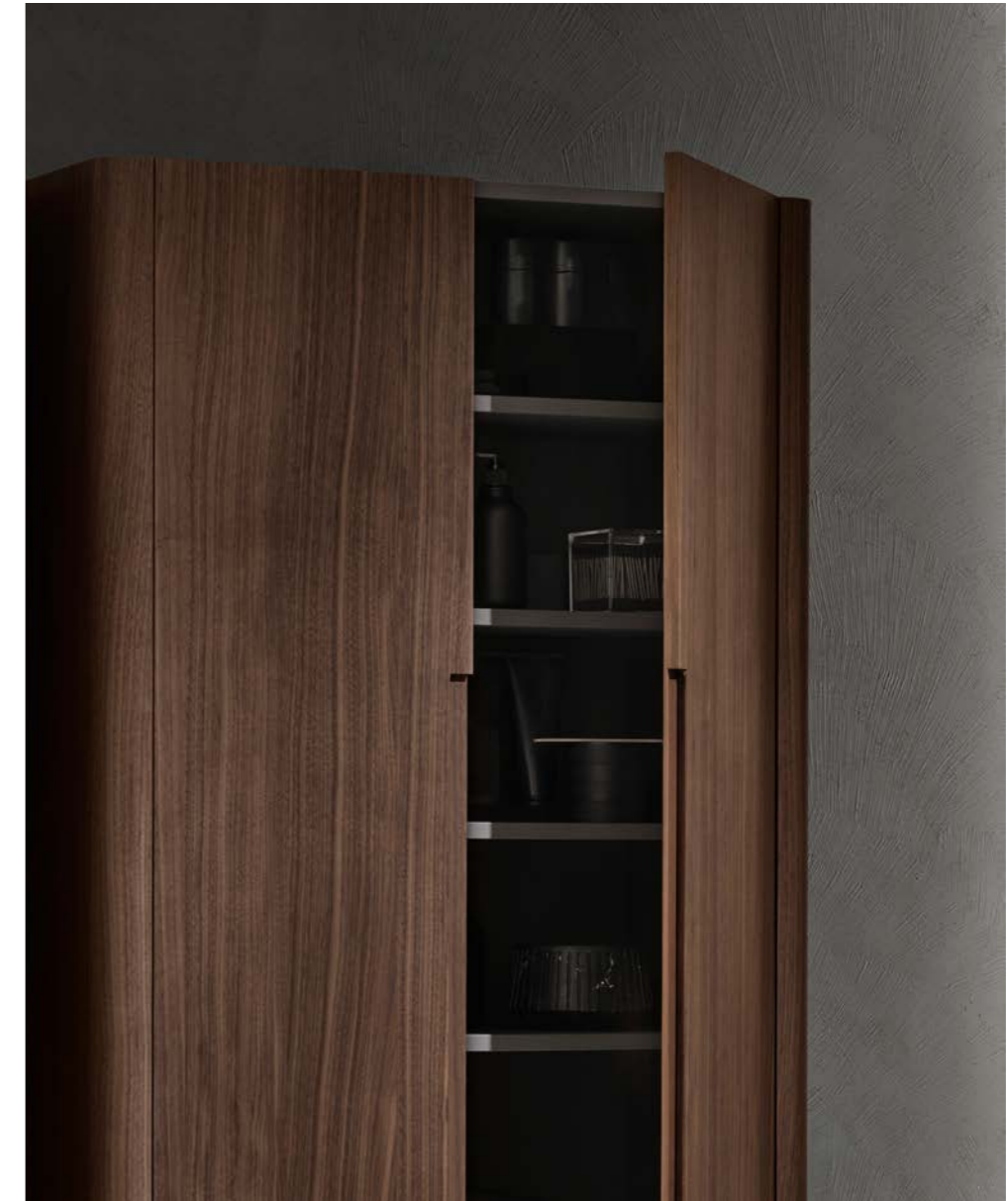

Nelle pagine precedenti le colonne a doppia anta in finitura Noce Canaletto L 92 P 35 H 150, Nella pagina accanto il dettaglio dei lavabi Circolo e del piano in marmo Bianco Carrara con bordo bisellato.

On the preceding pages, double-leaf columns in Canaletto Walnut finish L 92 W 35 H 150. On the next page, detail of Circolo sinks and White Carrara marble countertop with beveled edge.



Circolo *washbasin*

Circolo, il nuovo lavabo scultoreo di Falper, si distingue per la sua forma circolare e la sua presenza imponente. Disponibile in marmo e Cristalplant bio active bianco e colorato, questo lavabo si inserisce perfettamente in qualsiasi contesto, diventando un punto focale indiscusso. La sua versatilità lo rende un elemento trasversale tra le varie collezioni del brand.

Circolo, Falper's new sculptural basin, stands out for its circular shape and imposing presence. Available in marble and white and colored Cristalplant bioactive, this basin fits perfectly into any setting, becoming an undisputed focal point. Its versatility makes it a cross-cutting element among the various collections of the brand.





Mobile a doppio cassetto in finitura laccata lucida Ombra con lavabi e piano in marmo Pietra Grey. Rubinetteria Cilindro in acciaio inox spazzolato. Dimensioni L 200, P45, H 30 cm.

Double-drawer unit in glossy Shadow lacquered finish with Pietra Grey marble sinks and countertop. Brushed stainless steel Cylinder faucets. Dimensions cm L200, W45, H30.



Sistema colonne da parete composto da due colonne con fianco curvo e tre colonne centrali. Ante in dimensione 40 cm e maniglia a gola.
Finitura Noce Brown e dimensioni totali L212, P35, H150 cm.

Wall-mounted column system composed of two columns with curved sides and three central columns. Doors sized 40 cm with grooved handles. Brown Walnut finish and overall dimensions cm L212, W35, H150.





Nella pagina precedente
mobile a terra con ante
in finitura Noce Bruciato
con top in Cristalplant
e lavabo Homey da
appoggio Terra opaco.
Qui accanto mobile a
doppio cassetto con
piano integrato mod.
Round Soft e rubinetteria
Cilindro PVD Oro.

On the preceding page,
floor-standing unit with
Burnt Walnut finish
doors, Cristalplant top,
and mat Terra Homey
countertop basin. Next
to it, double-drawer unit
with integrated Round
Soft top and PVD Gold
Cylinder faucets.



La forma morbida del lavabo e la purezza del piano in Cristalplant Bio Active si integrano perfettamente con le linee arrotondate del mobile e con il nuovo specchio circolare con cornice in alluminio finitura Onice.

The soft shape of the sink and the purity of the Cristalplant Bio Active top seamlessly integrate with the rounded lines of the unit and the new circular mirror with Onyx aluminum frame finish.



**Abaco dimensioni /
Abaco Set dimensions**

H: 30
 L: 60 / 80 / 100 / 120 / 140 / 160
 L1: 60 / 80 / 100 / 120 / 140 / 160
 L2: 60 / 80 / 100 / 120 / 140 / 160
 D: 45

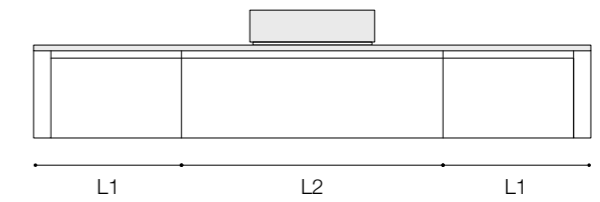
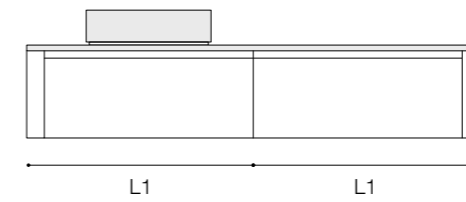
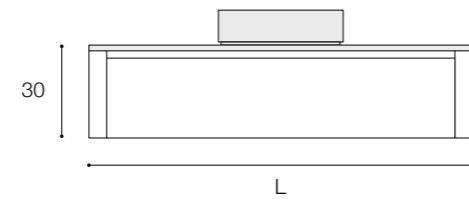

H: 45
 L: 60 / 80 / 100 / 120 / 140 / 160
 L1: 60 / 80 / 100 / 120 / 140 / 160
 L2: 60 / 80 / 100 / 120 / 140 / 160
 D: 45

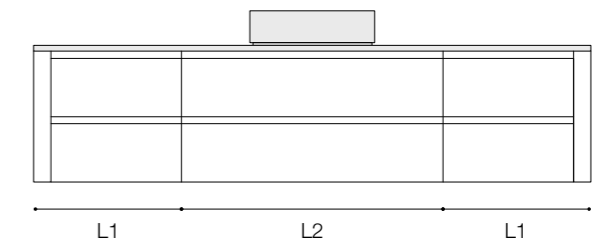
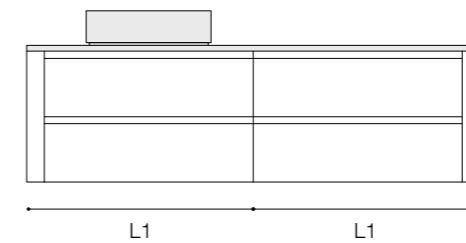
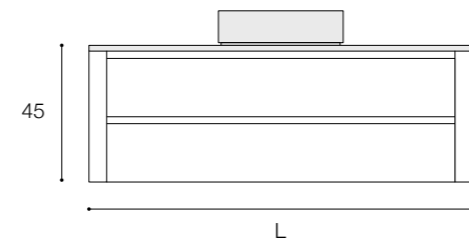

H: 75
 L: 54 / 66 / 78
 L1: 54 / 66 / 78
 L2: 48 / 60 / 62
 D: 45

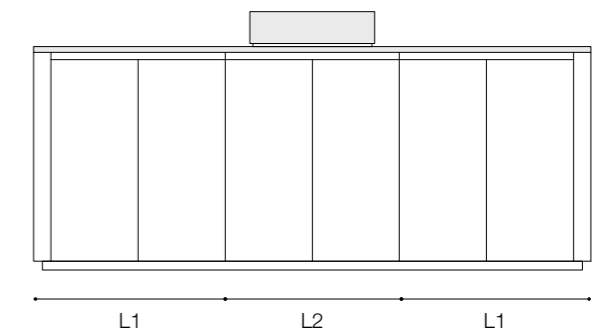
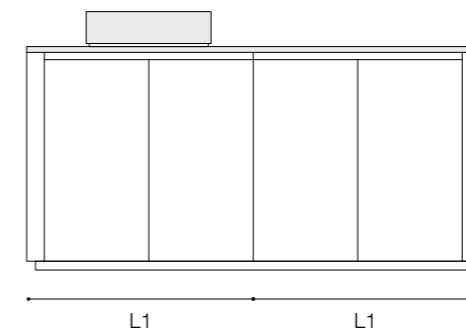
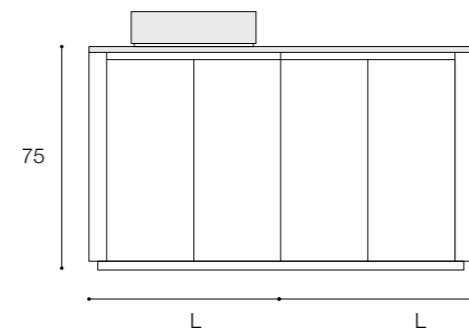

Abaco dimensioni /
Abaco Set dimensions

H: 150
L: 92 / 102
L1:36 / 46
L2:30 / 40
D: 20 / 35

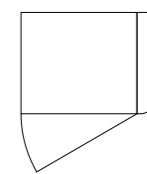
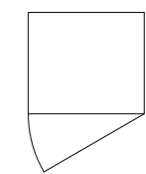
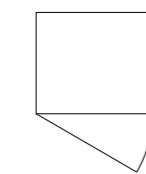
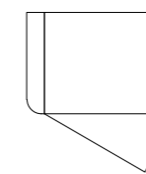
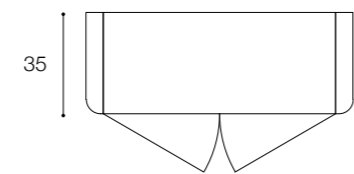
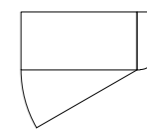
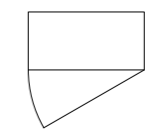
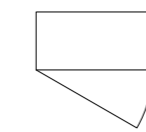
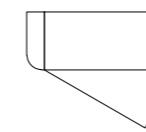
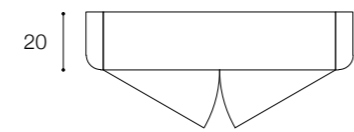
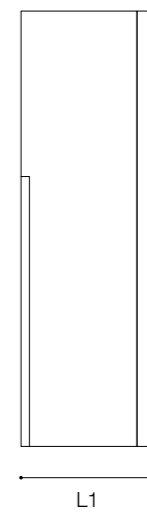
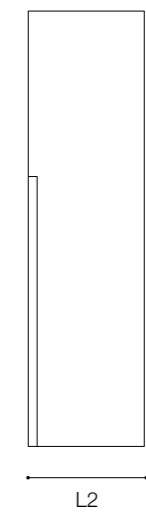
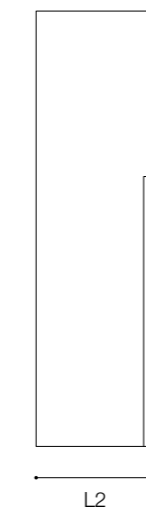
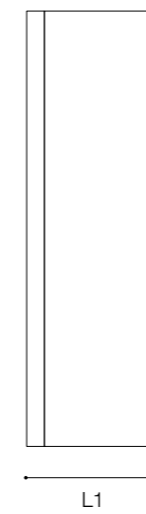
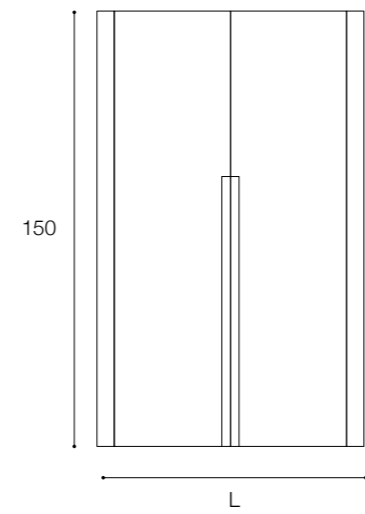

Viaveneto

Frame

La nuova evoluzione della collezione Viaveneto si presenta con un'anta dalla cornice in legno integrata ad una sofisticata maniglia metallica. Disponibile in essenza, legno rigatino tridimensionale e laccato lucido, questa collezione incarna un'estetica nordica contemporanea e molto elegante. Viaveneto Frame trasforma gli spazi in scenari di raffinata bellezza, dove ogni dettaglio contribuisce a creare un'atmosfera di prestigio e comfort.

The new evolution of the Viaveneto collection presents itself with a door featuring an integrated wooden frame with a sophisticated metal handle. Available in smooth wood, three-dimensional striped wood, and glossy lacquer, this collection embodies a contemporary and very elegant Nordic aesthetic. Viaveneto Frame transforms spaces into scenarios of refined beauty, where every detail contributes to creating an atmosphere of prestige and comfort.



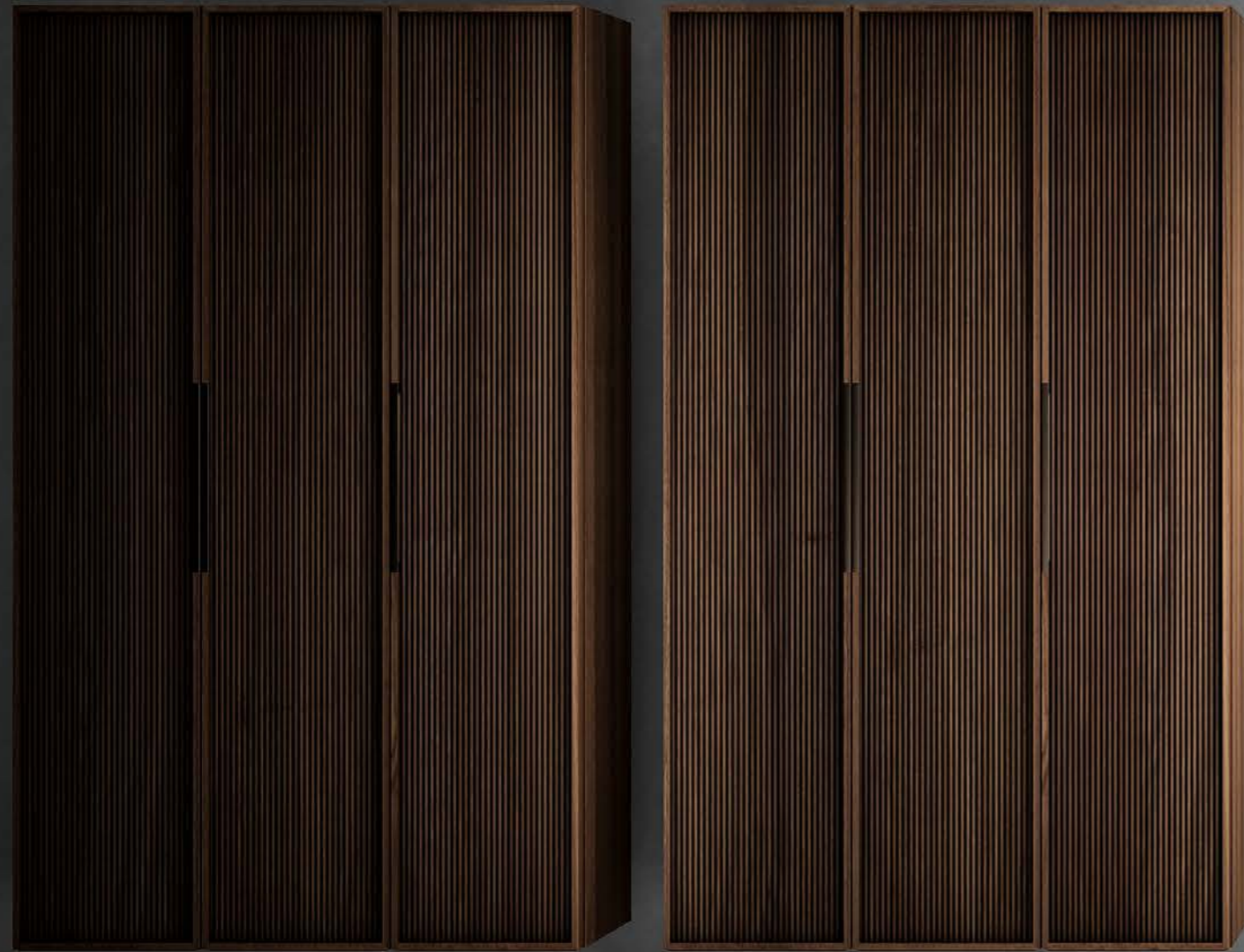



Nelle pagine precedenti il mobile con cassetti in legno Noce Canaletto rigatino con maniglie Ottone, piano e lavabi Circolo in Marmo Grigio Tundra. L200, H30, P45 cm. Qui accanto lo stesso mobile in Noce Naturale liscio con maniglia Ottone e lavabo Invaso in finitura Ghiaia Opaco.

On the preceding pages, unit with Canaletto Walnut grooved wood drawers and Brass handles, with Circolo sinks and Grigio Tundra Marble top. L200, H30, W45 cm. Next to it, the same unit in smooth Natural Walnut with Brass handles and Invaso basin in mat Gravel finish.



Invaso

washbasin

Invaso è il nuovo lavabo rettangolare di Falper caratterizzato dal rigore delle forme e dall'ampio bacino a tutta larghezza. Disponibile nelle dimensioni 80, 100 e 120 in profondità 45 e altezza 10 cm è realizzato in Cristalplant Bio Active bianco e colorato.

Invaso is Falper's new rectangular sink characterized by strict forms and a wide basin. Available in sizes 80, 100, and 120 with a depth of 45 and a height of 10 cm, made of white and colored Cristalplant Bio Active.

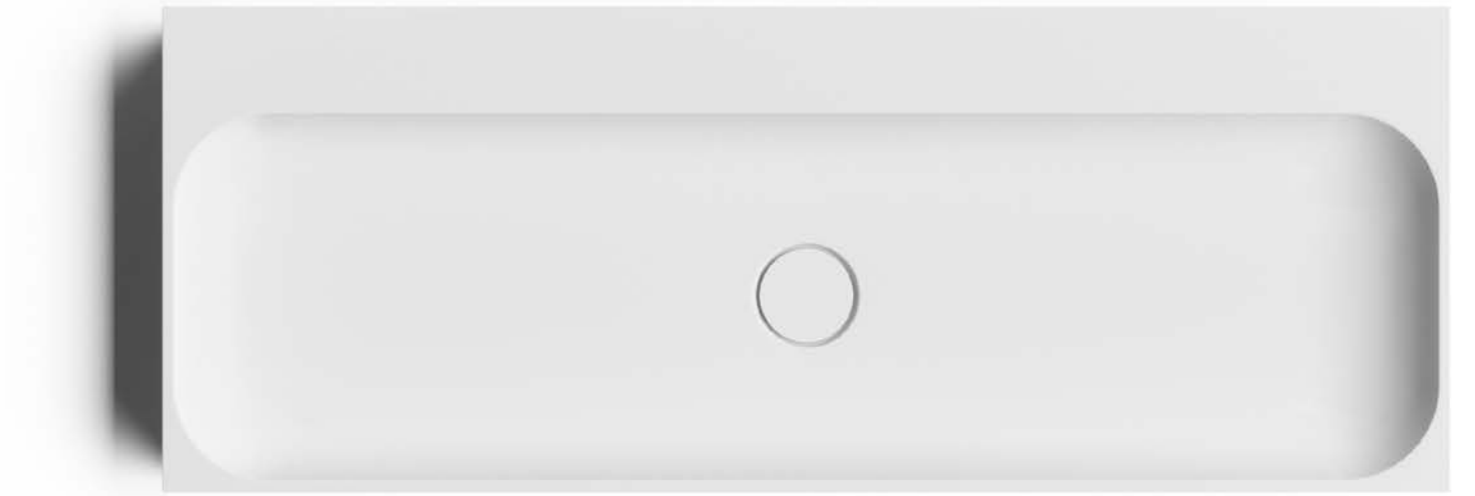

Qui accanto il mobile a doppio cassetto Viaveneto Frame in finitura laccata lucida con maniglie acciaio spazzolato, top e lavabo in Cristalplant Bio Active. Dimensioni L160, H50, P45 cm.

Next to it, the Viaveneto Frame double-drawer unit in glossy lacquer finish with brushed stainless steel handles, top, and sink in Cristalplant Bio Active. Dimensions cm L160, H50, W45.



**Abaco dimensioni /
Abaco Set dimensions**

H: 30
L: 60 / 80 / 90 / 100 / 120
L1: 30 / 60
D: 45 / 55

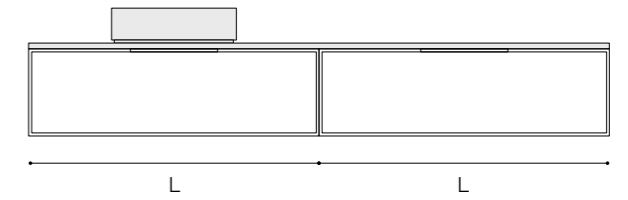
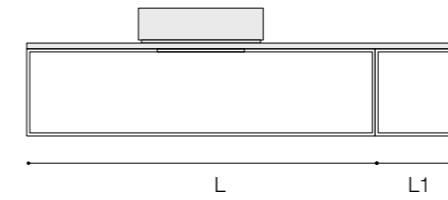
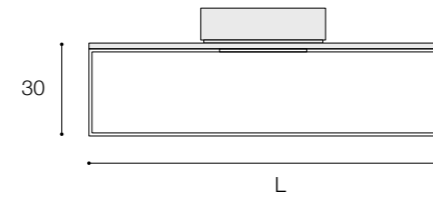

H: 45
L: 60 / 80 / 90 / 100 / 120
L1: 30 / 60
D: 45 / 55

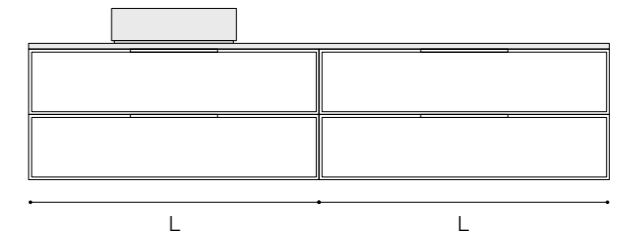
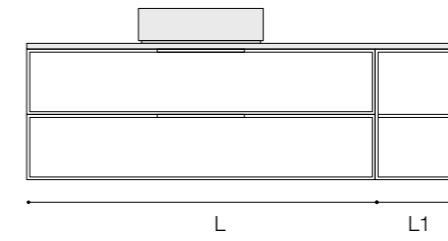
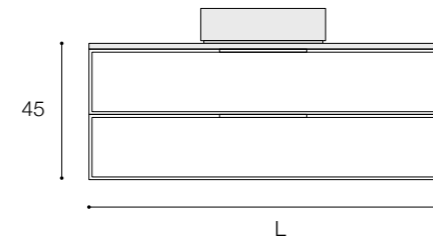

H: 150
L: 30 / 40
L1: 40
L2: 30
D: 20 / 35

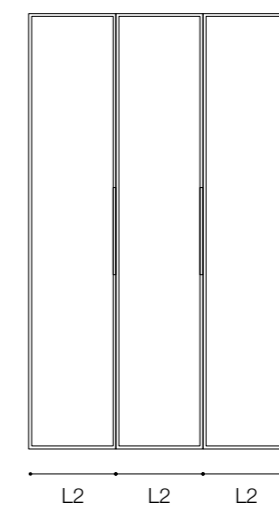
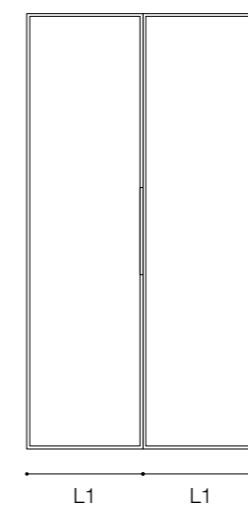
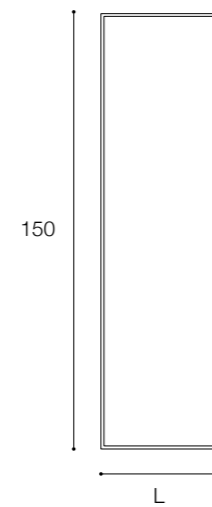

Viaveneto

colonne da incasso

Il sistema guardaroba di Viaveneto si compone di colonne e sopra colonne dimensionabili in larghezza ed altezza, con possibilità di essere posizionate ad incasso o con fianchi a vista. Unicamente elegante è disponibile in tutte le finiture Falper.

Viaveneto's wardrobe system consists of customizable columns and over-columns in width and height, suitable for recessed or visible sides installation. Elegantly unique, available in all Falper finishes.





**Abaco dimensioni /
Abaco Set dimensions**

H: 30 – 100
L: 40 / 60
D: 35 / 45

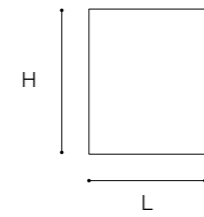

H: 200
L: 40 / 60
L1: 60
L2: 40
D: 35 / 45

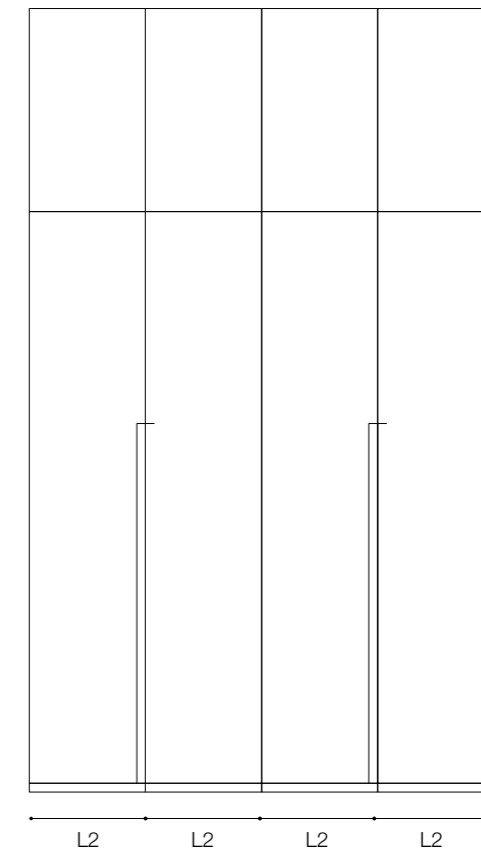
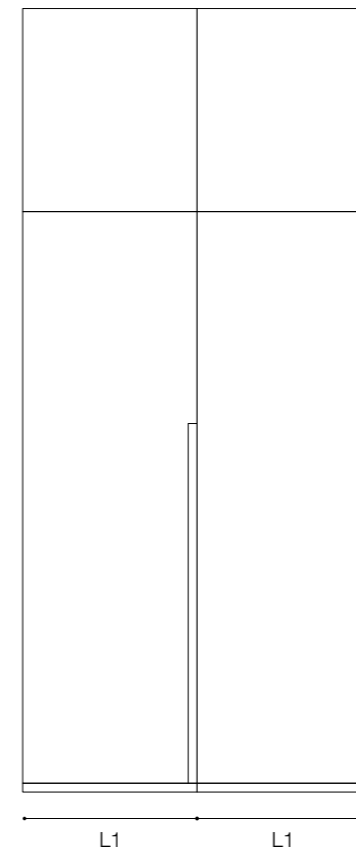
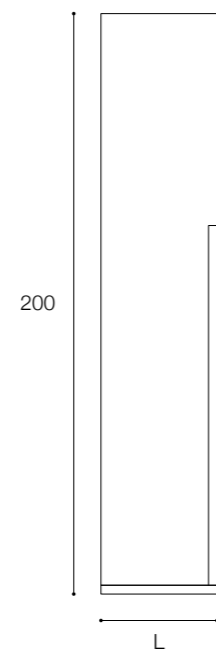

Glacette *washbasin*

L'architetto Victor Vasilev basa il suo processo di ricerca nei progetti di design su alcuni punti di riferimento consolidati. Il suo stile, in apparenza rigoroso, cela un'ispirazione poetica. Glacette è piena espressione di questa unica sensibilità. Realizzato in Cristalplant Bio Active con diametro di 43 e altezza di 17 cm può essere fornito in bianco e colorato.

Architect Victor Vasilev's design process is based on well-established reference points, blending apparent rigor with poetic inspiration. Glacette epitomizes this unique sensitivity, made in Cristalplant Bio Active with a diameter of 43 and a height of 17 cm, available in white and colored versions.



UNIQUENESS

Senzafine

Senzafine è l'innovativa soluzione di arredo che consente la realizzazione di piani con lavabi in appoggio e integrati, in pregiato marmo e solid surface, anche di dimensioni oltre i tre metri. Seppur utilizzando elementi standard, di semplice installazione, Senzafine permette un'integrazione perfetta senza soluzione di continuità.

Senzafine is the innovative furnishing solution that allows the creation of countertops with both freestanding and integrated sinks, in fine marble and solid surfaces, even in sizes exceeding three meters. Despite using standard elements of simple installation, Senzafine enables perfect integration without interruption.





Nella pagina accanto
la composizione con
piano laccato lucido
Bianco su misura e
lavabo Onda in marmo
Statuario si completa
con le rubinetterie
Cilindro PVD Oro e
con il nuovo specchio
pieghevole con
ingranditore e luce led.

On the next page,
the composition with
custom glossy White
top and Onda marble
sink is complemented
by PVD Gold Cylinder
faucets and the new
folding mirror with
magnifier and LED
light.



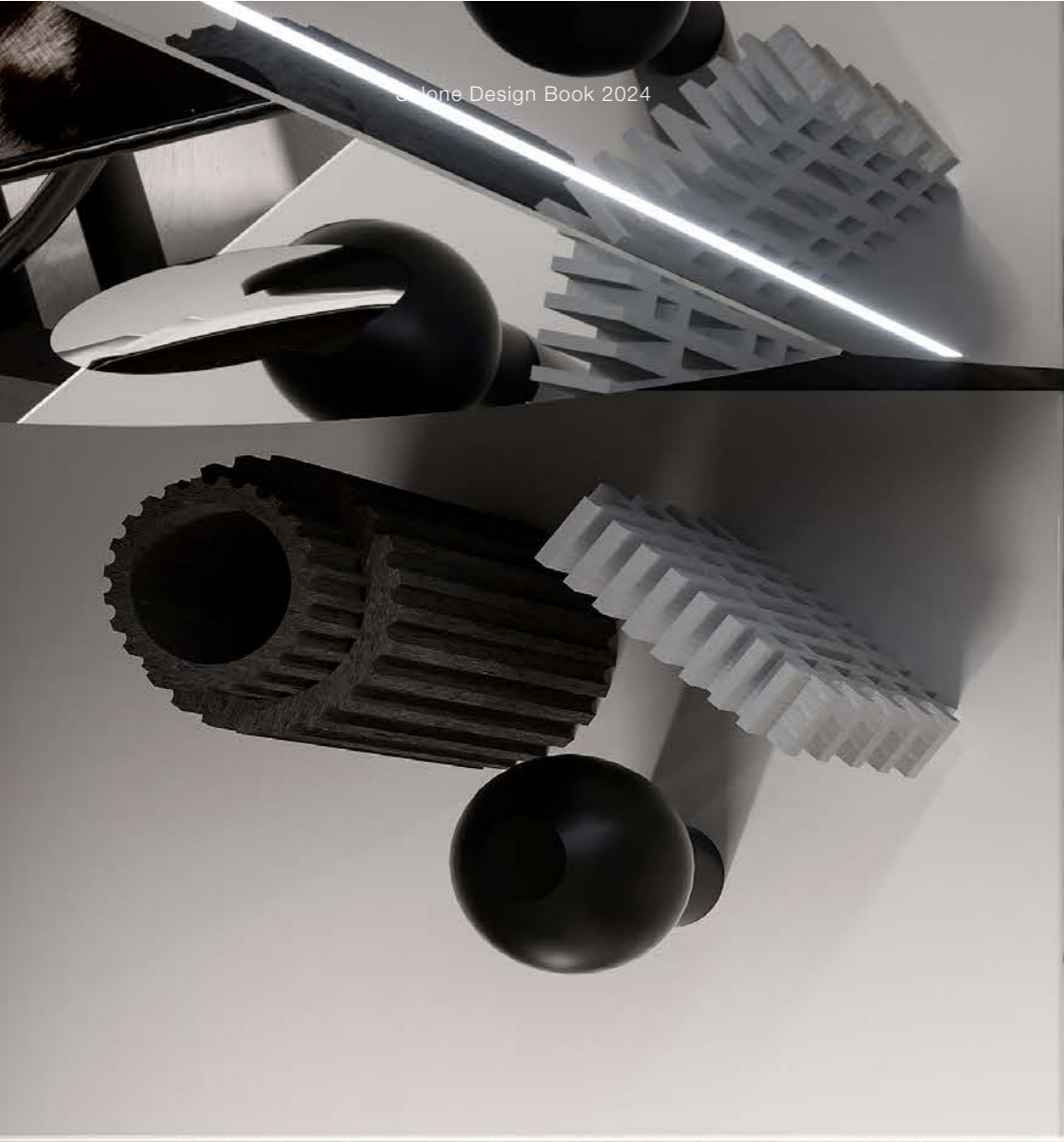

Onda *washbasin*

Un solido blocco di marmo viene scavato in superficie generando la forma di un Onda che trasforma il piano di appoggio in un capiente quanto elegante lavabo. Onda è disponibile in cinque tipologie di marmo e nelle dimensioni di 80 e 120 cm per una profondità di 45 cm ed una altezza di 10 cm.

A solid block of marble is carved on the surface to create the shape of a Wave, transforming the countertop into a spacious and elegant basin. Onda is available in five types of marble and in sizes of 80 and 120 cm with a depth of 45 cm and a height of 10 cm.



Nella collezione Senzafine le giunzioni tra piani sono gestite con un sistema di fissaggio e con guarnizioni invisibili a tenuta.

In the Senzafine collection the joints between tops are managed with a fixing system and invisible gaskets for sealing.





La collezione Senzafine consente di realizzare piani di infinita lunghezza anche con lavabi di appoggio, grazie alla presenza di piani porta lavabo in Cristalplant e Marmo.

The Senzafine collection allows for infinitely long countertops even with countertop sinks, thanks to the presence of Cristalplant and Marble sink holder tops.

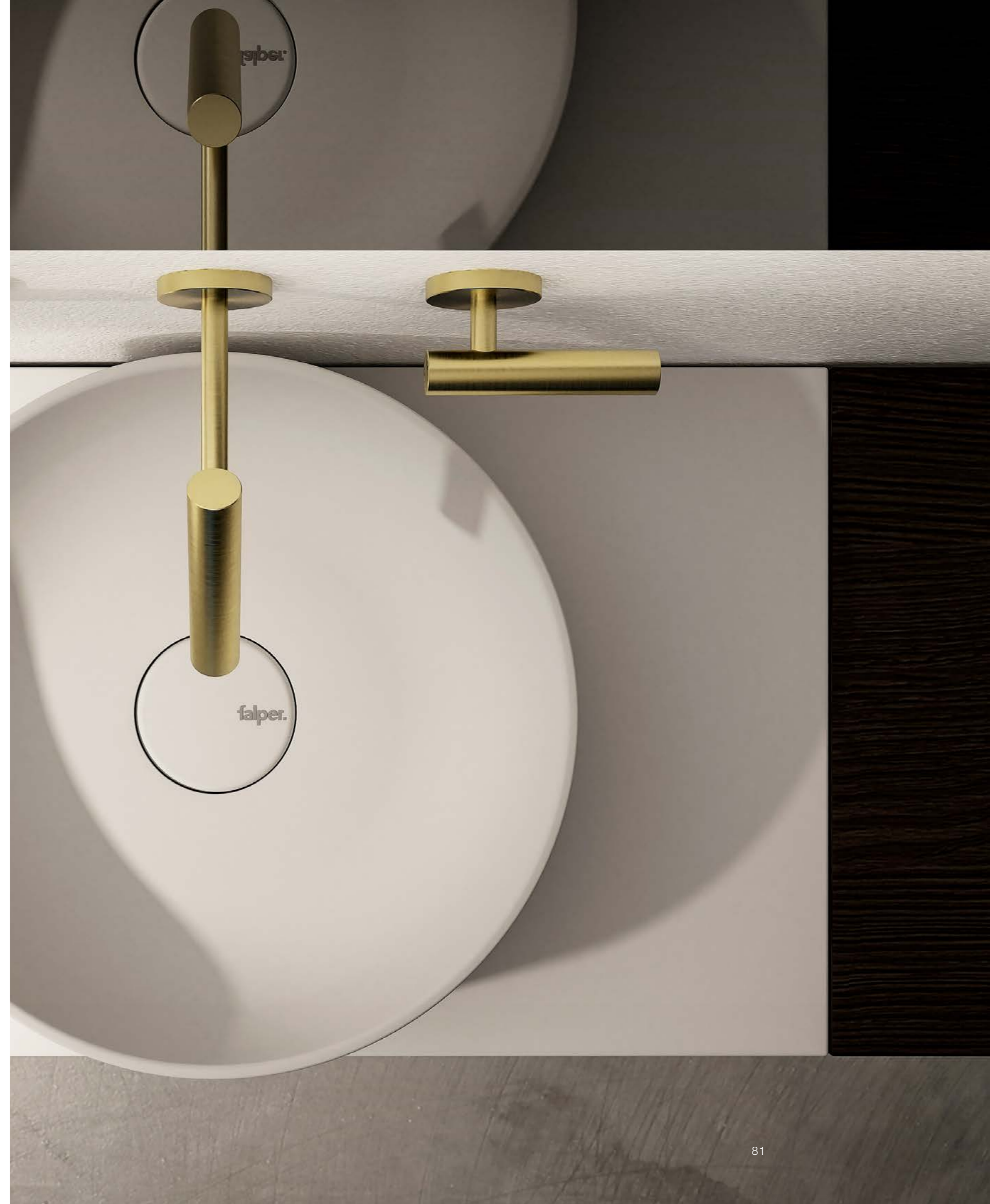



Composizione Senzafine con top centrale porta lavabo in Cristalplant L120 e doppio piano laterale in legno Noce Brown su misura. Cassettiera doppia H25 cm realizzata nelle dimensioni dei piani.

Senzafine composition with central Cristalplant sink holder top L 120 and double side wood top in custom Brown Walnut. Double chest of drawers H 25 cm made in the sizes of the tops.



Cala Fluida

washbasin

Un solido blocco di marmo viene scavato in superficie generando la forma fluida di una Cala che trasforma il piano di appoggio in un capiente quanto elegante lavabo. Cala Fluida è disponibile in cinque tipologie di marmo e nelle dimensioni di 80 e 120 cm per una profondità di 45 cm ed una altezza di 10 cm.

A solid block of marble is carved on the surface to create the fluid shape of a Cove, transforming the countertop into a spacious and elegant basin. Cala Fluida is available in five types of marble and in sizes of 80 and 120 cm with a depth of 45 cm and a height of 10 cm.



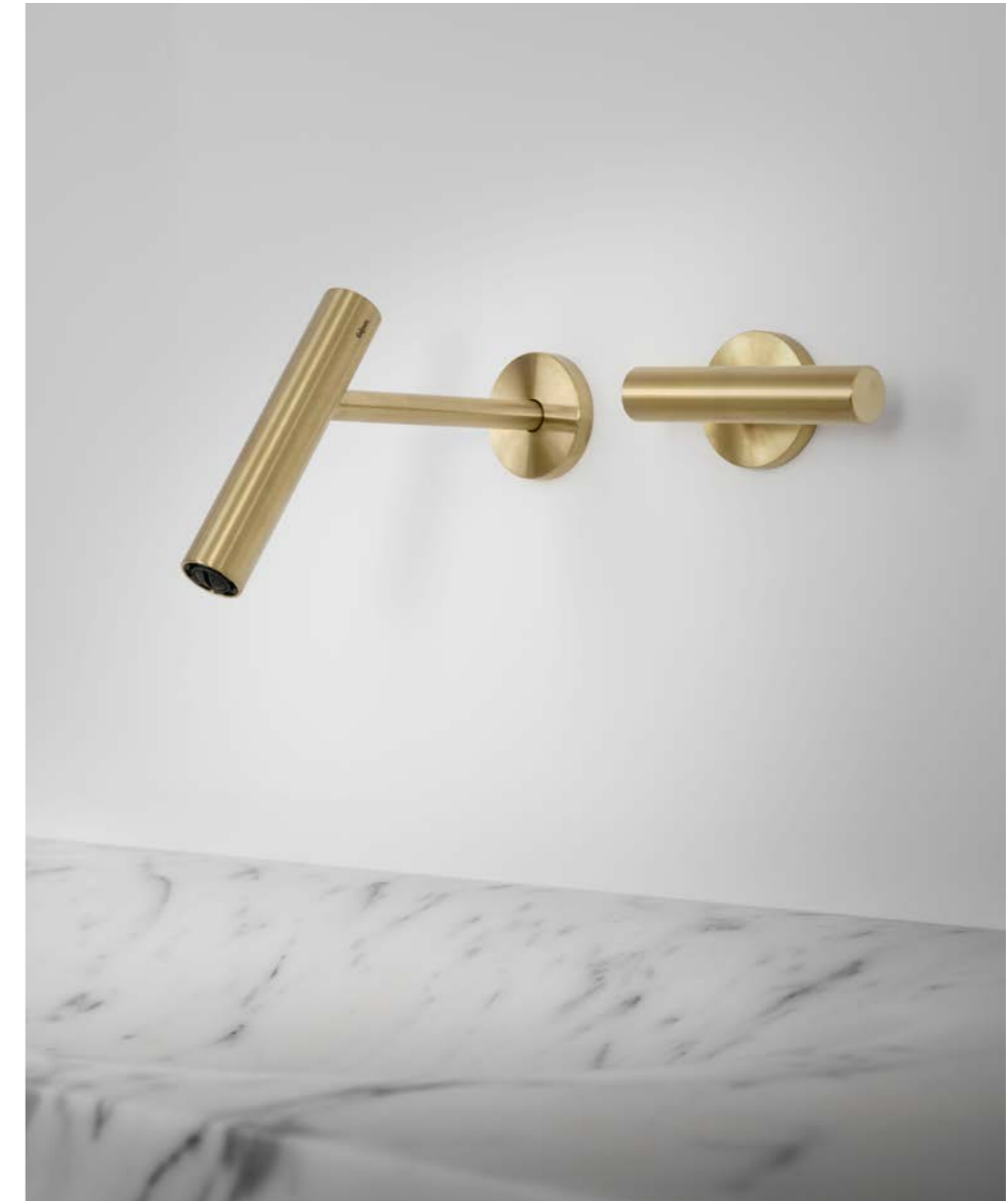

**Abaco dimensioni /
Abaco Set dimensions**

H: 10
 L: 80 / 100 / 120 / 140 / 160
 180 / 200 / 220 / 240 / 260 / 280
 L1: 80 / 120
 D: 45

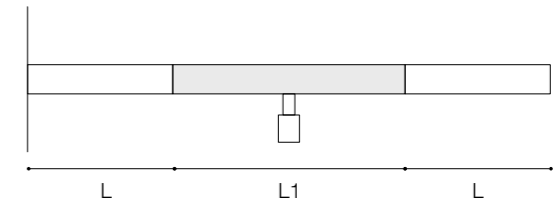
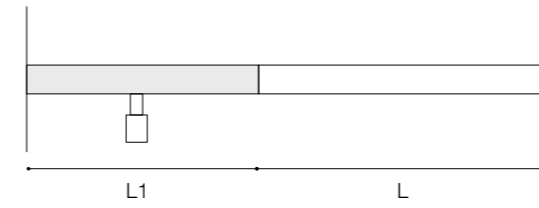
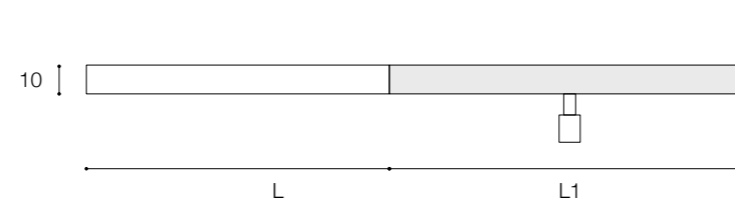

H: 10
 L: 80 / 100 / 120 / 140 / 160
 180 / 200 / 220 / 240 / 260 / 280
 L1: 80 / 100 / 120 / 140 / 160
 180 / 200 / 220 / 240
 D: 45

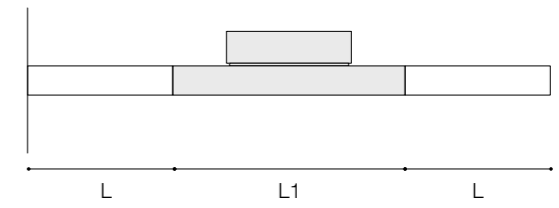
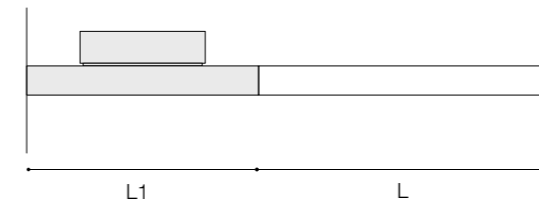
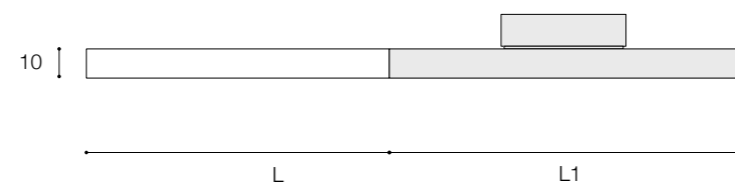

H: 10
 L: 60 / 80 / 100 / 120 / 140 / 160
 D: 45

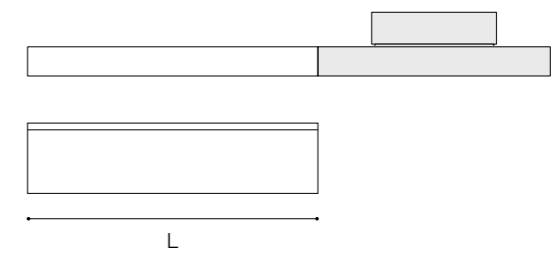
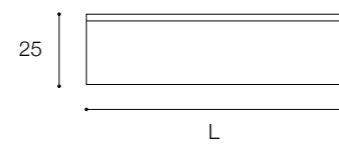

Ognidove

Ognidove è il mobile contenitivo versatile per eccellenza, con profondità ridotta di 25 e 35 cm, è ideale per ogni spazio del bagno e non solo. Citazione del concept bagno presentato da Falper oltre venti anni orsono, è ideale in abbinamento a lavabi e vasche free standing ed offre contenimento e appoggio con stile e funzionalità.

Ognidove is the versatile storage unit par excellence, with reduced depths of 25 and 35 cm, ideal for every bathroom space and beyond. A tribute to the bathroom concept presented by Falper over twenty years ago, it is ideal when paired with freestanding sinks and tubs, offering containment and support with style and functionality.







Composizione di due
basi componibili da
150 x 30 cm in finitura
Noce Naturale fiammato
con base a giorno da
90 x 30 cm in laccato
Ghiaia opaco. Lavabo a
terra Sorgente e vasca
Homey in Cristalplant
Ghiaia opaco.

Composition of two
modular bases of 150 x
30 cm in Flamed Natural
Walnut finish with open
base of 90 x 30 cm
in mat Gravel lacquer.
Sorgente floor basin and
Homey bathtub in mat
Gravel Cristalplant.



Sorgente

Sorgente è l'iconico lavabo a terra dalle forme scultoree, disegnato dall'architetto Victor Vasilev, realizzato nella pregiata selezione di marmi di Falper, oltrechè in solid surface bianco e colorato. Un elemento unico che si distingue per le sue dimensioni di 50 cm di diametro e 90 cm di altezza, conferendo al bagno un'aura di eleganza e raffinatezza.

Sorgente is the iconic floor-standing basin with sculptural forms, designed by architect Victor Vasilev, crafted in Falper's fine selection of marbles, as well as in white and colored solid surfaces. A unique element distinguished by its dimensions of 50 cm in diameter and 90 cm in height, bestowing an aura of elegance and sophistication upon the bathroom.









Composizione in Curry lucido con interni in finitura pelle primo fiore grigio e lavabo Sorgente in marmo Rosso Levanto. Specchio pieghevole da 100 cm con ingranditore e illuminazione led.

Composition in glossy Curry with interiors in first-grade gray leather finish and Sorgente sink in Rosso Levanto marble. 100 cm folding mirror with magnifier and LED lighting.

**Abaco dimensioni /
Abaco Set dimensions**

H: 76
L: 30 / 60 / 90 / 120 / 150
D: 20 / 30

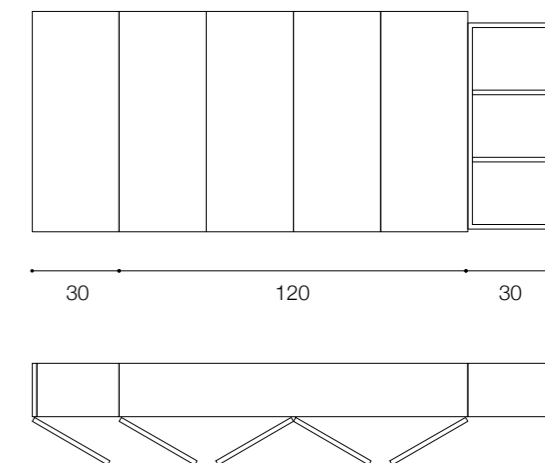
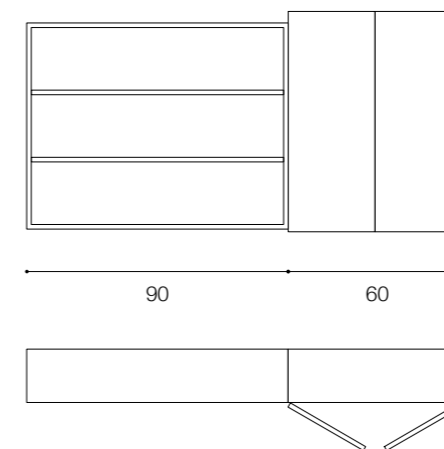
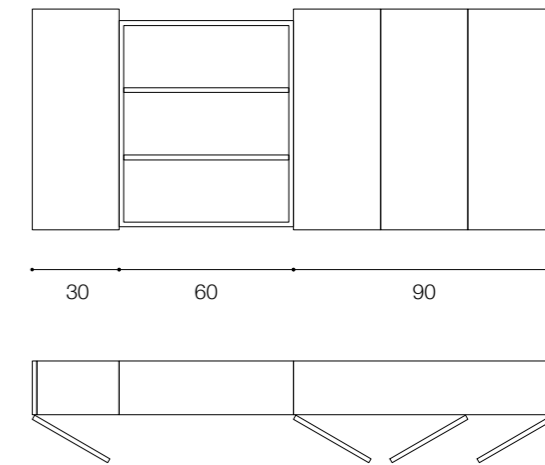
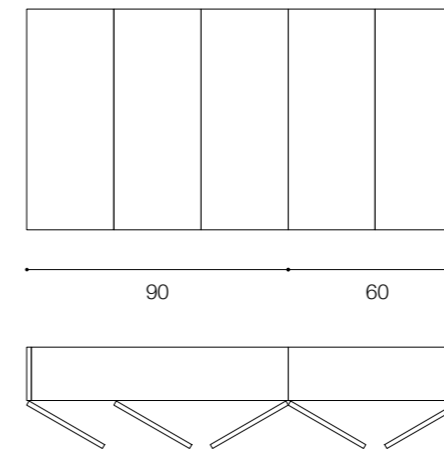
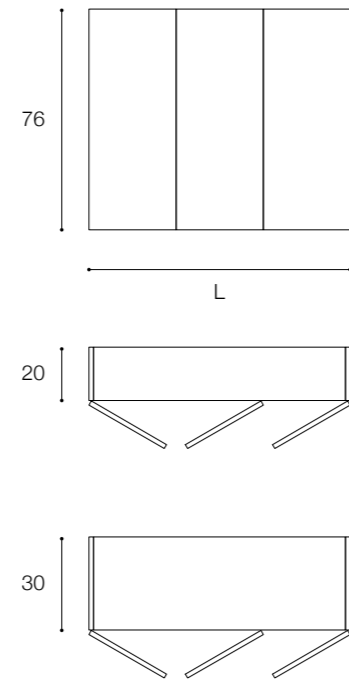

Don't mind *the kitchen*

Le piccole cucine living Small Living Kitchens™, già vincitrici del EDIDA 2023, sono gioielli di design e funzionalità. Queste esclusive quanto inedite soluzioni di arredo sono perfette per integrare la cucina nello spazio living con stile e praticità.

The Small Living Kitchens™, already winners of the 2023 EDIDA, are jewels of design and functionality. These exclusive yet innovative furnishing solutions are perfect for integrating the kitchen into the living space with style and practicality.







Small Living Kitchens

Small Living Kitchens™ is a unique system that revolutionizes the way kitchens are experienced within compact spaces. Inspired by the award-winning design of the 2022 EDCO award, they are complemented by several functional elements such as tables and stools. The design, curated by **Andrea Federici**, pays particular attention to perfect stylistic and functional integration.

Small Living Kitchens™ is a unique system that revolutionizes the way kitchens are experienced within compact spaces. Inspired by the award-winning design of the 2022 EDCO award, they are complemented by several functional elements such as tables and stools. The design, curated by **Andrea Federici**, pays particular attention to perfect stylistic and functional integration.



BALANCE

Foster +*Partners*

Falper presenta in anteprima mondiale la collaborazione con lo studio londinese Foster+ Partners. Nasce una straordinaria collezione di arredi per il bagno, uno sguardo in avanti per promuovere bellezza e qualità e per essere l'occasione di riflettere sulle proposte nei nuovi spazi domestici.

Falper presents the exclusive preview of a collaboration with the London-based studio Foster+ Partners. An extraordinary collection of bathroom furnishings, the collection is a forward-looking archetype of beauty and quality and an opportunity to contemplate ideas for new kinds of living spaces.

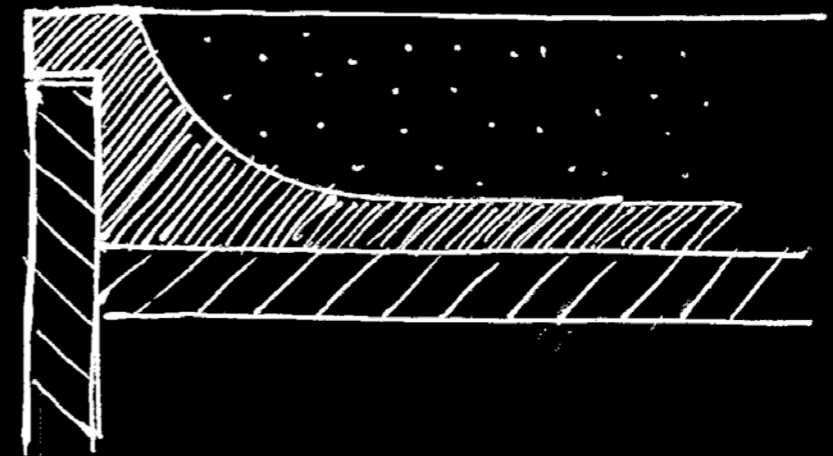

MA

MA è l'iconica collezione disegnata da Foster + Partner per Falper, vincitrice del EDIDA 2024 come miglior collezione bagno al mondo. Il design unico, le configurazioni a isola e a parete, insieme ai dettagli costruttivi di eccellente ebanisteria, la rendono una scelta di grande prestigio per ogni ambiente bagno.

MA is the iconic collection designed by Foster + Partners for Falper, winner of the 2024 EDIDA award for the best bathroom collection in the world. Its unique design, island and wall configurations, along with excellent craftsmanship details, make it a prestigious choice for any bathroom environment.





L'isola MA in Noce Brown e il lavabo in Marmo Jolie Grey si completano con con bocca di erogazione MA in acciaio inox PVD nero con porta oggetti e specchio a terra con illuminazione LED.

The MA island in Brown Walnut and the Jolie Grey marble sink are complemented by the Black PVD stainless steel MA spout with storage and floor mirror with LED lighting.



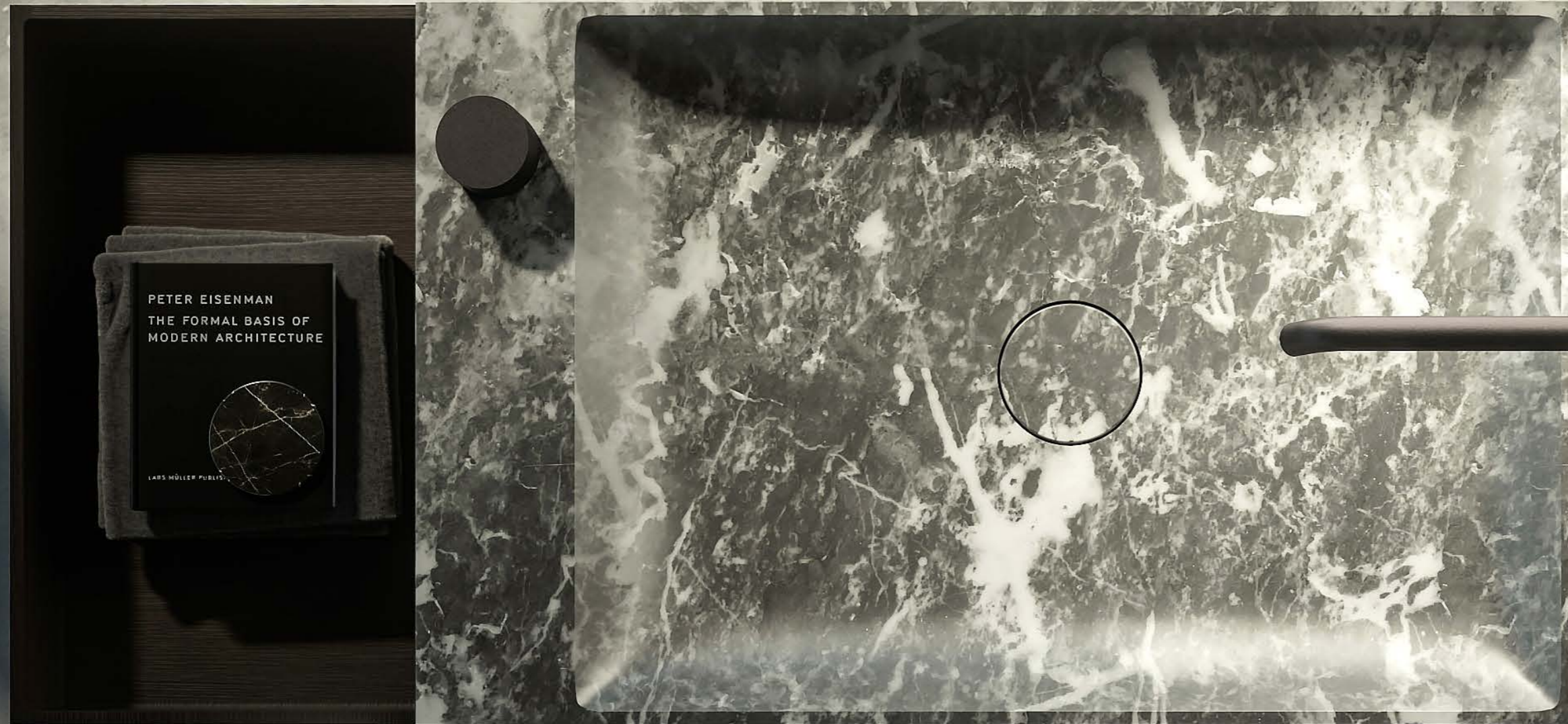

MA *Elements*

MA Elements l'evoluzione straordinaria del celebre design di Foster+Partners, che propone soluzioni innovative per il settore contract e HoReCa. Riprogettata in pannello da 10 mm accoglie le finiture eccellenti tipiche di Falper e anche materiali destinati al contract come HPL e nobilitati.

MA Elements, the extraordinary evolution of Foster+Partners' famous design, which proposes innovative solutions for the contract and HoReCa sectors. Redesigned in 10 mm panel, it welcomes the excellent finishes typical of Falper and also materials destined for the contract sector such as HPL and laminates.







In queste pagine la collezione MA Elements H 25 con cassetti in uno scenario metropolitano realizzata nella configurazione, nella larghezza e con finitura nobilitata richieste dallo specifico progetto contract residenziale.

In these pages, the MA Elements collection H 25 with drawers in a metropolitan scenario, realized in the configuration, width, and laminated finish required by the specific residential contract project.





MA Elements in finitura nobilitato Quercia Rovere nella configurazione piano multi lavabo con mensole porta oggetti. Nella pagina seguente la stessa collezione nella versione a terra, con vani a giorno laterali, in finitura nobilitata Quercia noce.

MA Elements in Oak laminate finish in the multi-sink countertop configuration with object shelves. On the next page, the same collection in the floor version, with side open compartments, in Oak Walnut laminated finish.



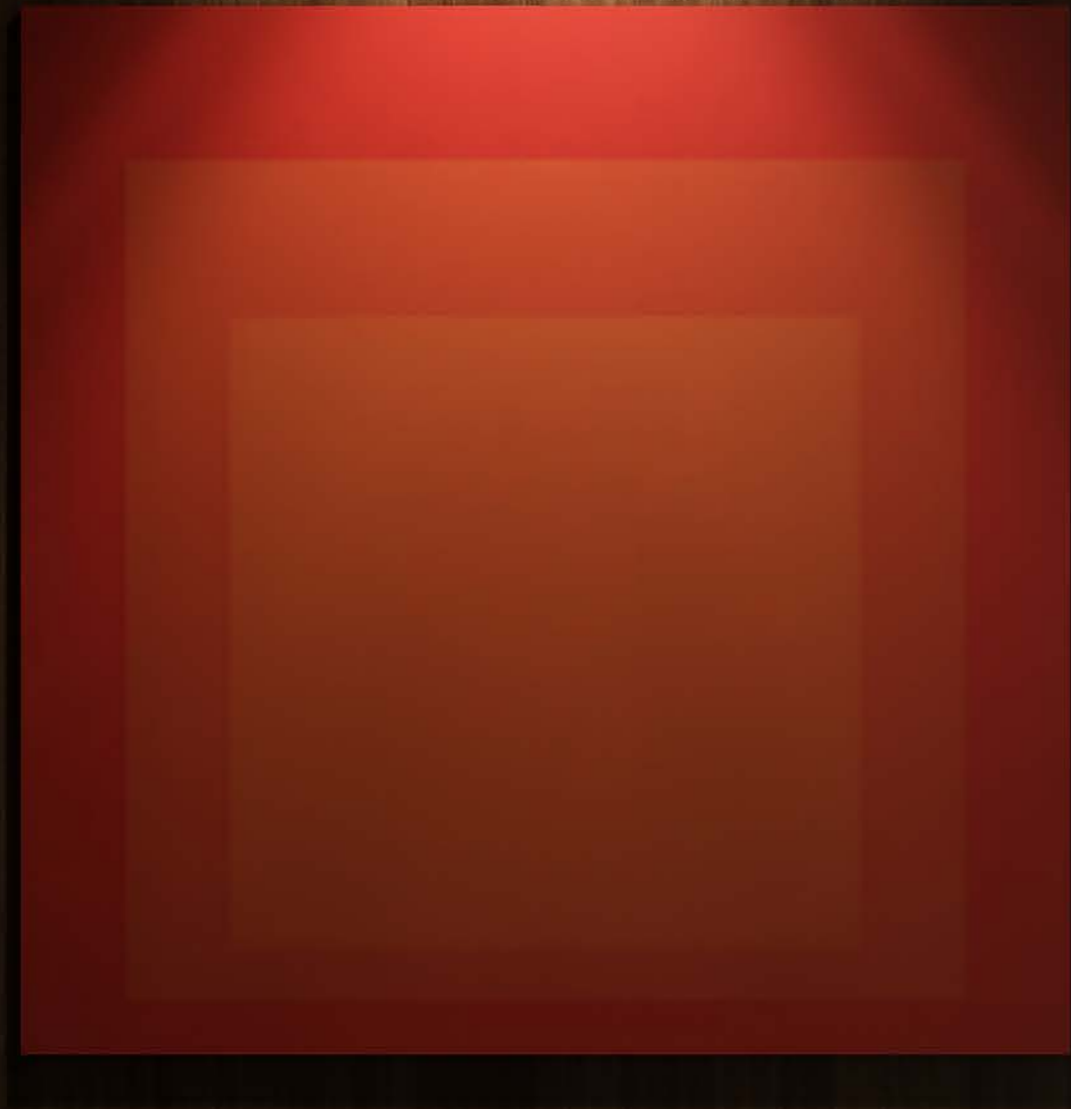



**Abaco dimensioni /
Abaco Set dimensions**

H: 25
L: 100 / 120 / 140 / 160
L1: 40 / 60 / 80 / 100 / 120 / 140 / 160
D: 45

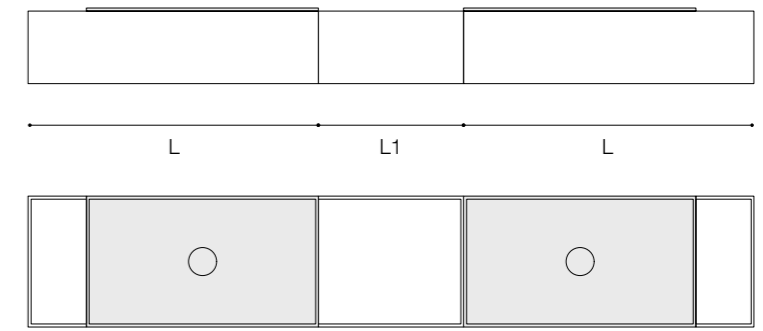
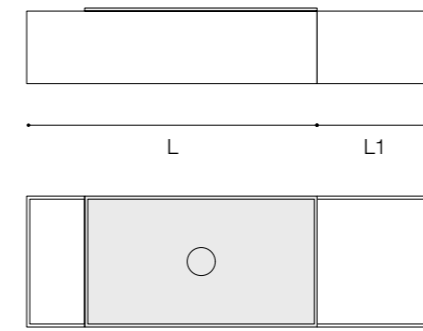
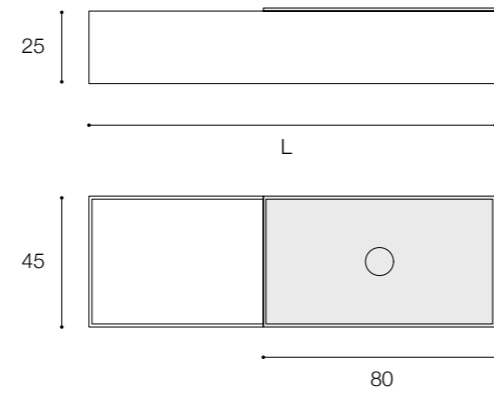

H: 36
L: 100 / 120 / 140 / 160
L1: 40 / 60 / 80 / 100 / 120 / 140 / 160
D: 45

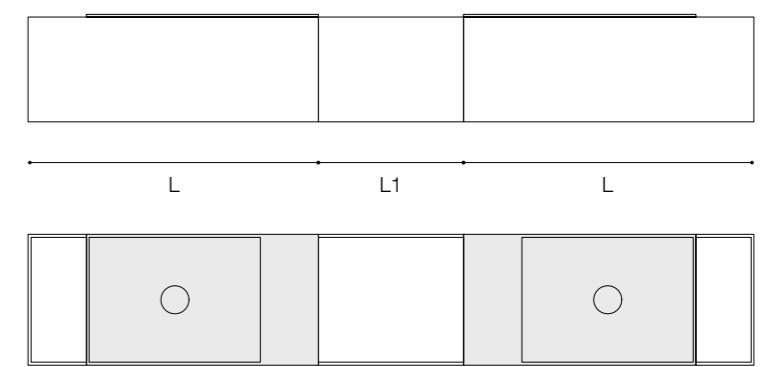
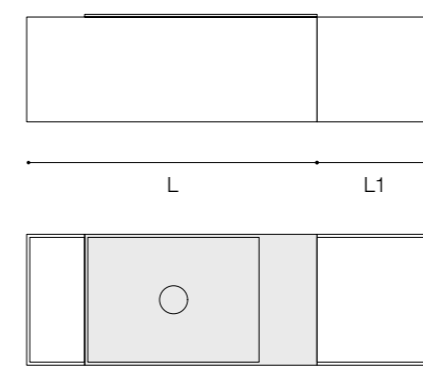
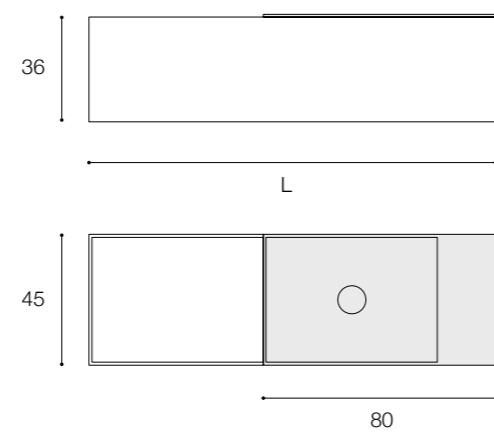

Abaco dimensioni /
Abaco Set dimensions

H: 87
L: 80
D: 45

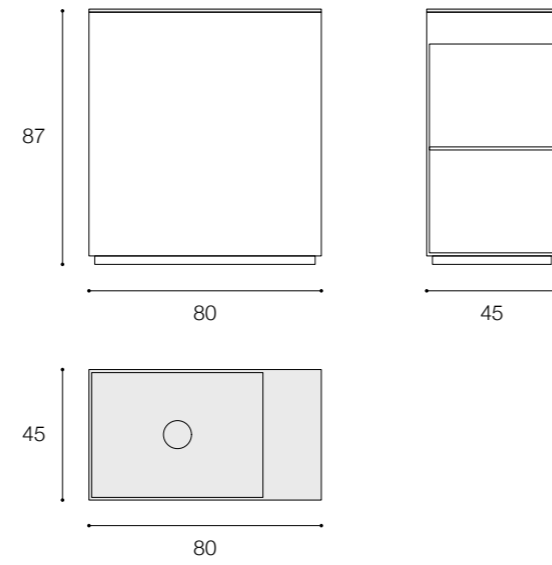

H: 15
L: 100 / 120 / 140 / 160 / 180
200 / 220 / 240 / 260 / 280 / 300
D: 45

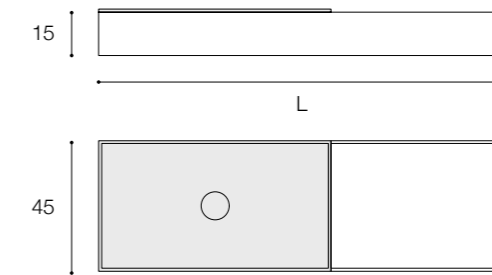

H: 15
L: 180 / 200 / 220 / 240
260 / 280 / 300
D: 45

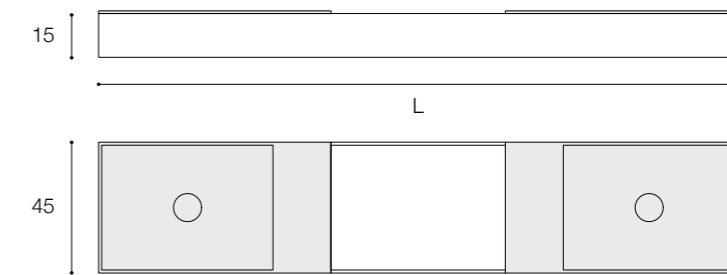

H: 15
L: 280 / 300
D: 45

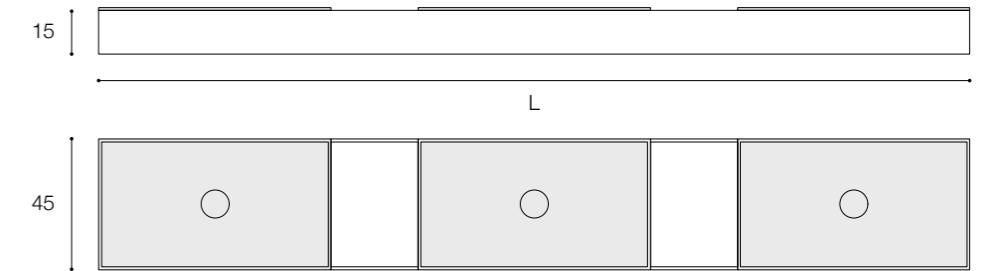

Butler *wood*

Il sistema guardaroba Butler si arricchisce della versione con mensole interne in legno, particolarmente richieste nella profondità 20 cm. Butler è il punto di riferimento tra i sistemi di contenimento per il bagno grazie alla sua unica eleganza e ricercatezza dei dettagli.

The Butler wardrobe system is enriched by the version with internal wooden shelves, particularly demanded in the 20 cm depth. Butler is the reference point among bathroom storage systems, thanks to its unique elegance and detailed sophistication.





A firma del designer
Andrea Federici questa
collezione di colonne
a giorno è destinata
a qualsiasi ambiente
domestico e alberghiero
e si presta a varie
personalizzazioni di
finitura e funzione.

Designed by Andrea
Federici, this collection
of open shelves
is suitable for any
domestic and hotel
environment and
lends itself to various
finish and function
customizations.

Victor *Vasilev*

L'architetto Victor Vasilev basa il suo processo di ricerca nei progetti di design su alcuni punti di riferimento consolidati. Il suo stile, in apparenza rigoroso, cela un'ispirazione poetica, con la voglia di sperimentare e di sorprendere, anche se la geometria è la via maestra da seguire. Collabora con Falper dal 2018, ottenendo da allora diversi riconoscimenti internazionali.

Architect Victor Vasilev bases his design research process on a few consolidated touchstones. His apparently unembellished style conceals a poetic heart, and a desire to experiment and to surprise, although geometry remains his guiding concept. He has collaborated with Falper since 2018, receiving several international awards during these years.

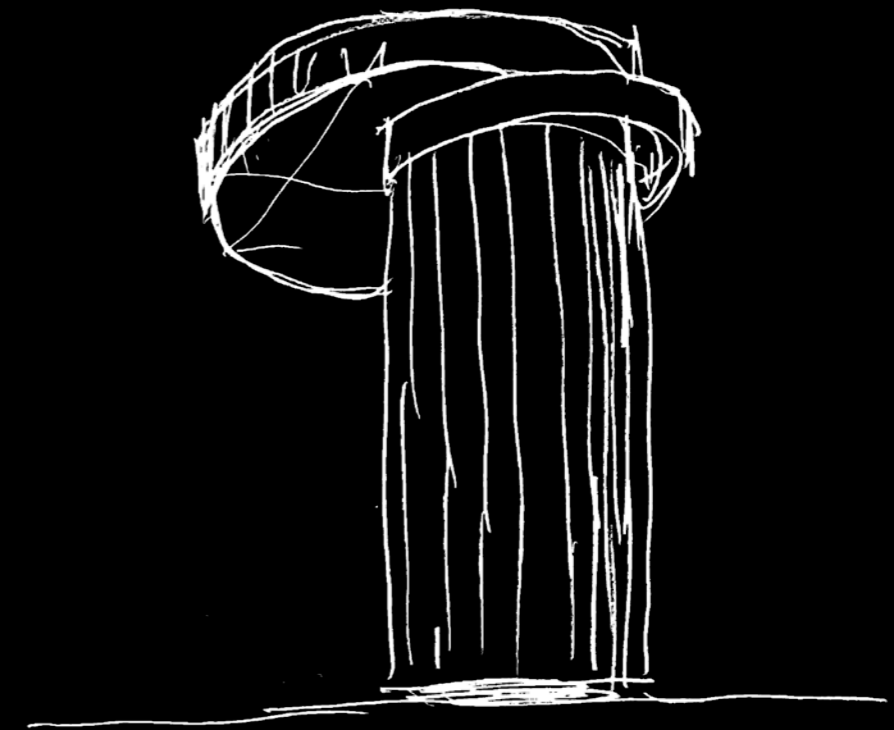

Eccentrico *rigatino*

L'iconico design si arricchisce con l'inclusione del pregiato legno rigatino, che aggiunge un tocco di calore e raffinatezza alla gamma. Oltre alla vasta scelta di materiali, dal Cristalplant al marmo, Falper continua a offrire soluzioni di design creando un'esperienza unica e raffinata qui arricchita dalla presenza della nuova finitura PVD Oro nella collezione di rubinetterie Cilindro a firma dello stesso designer.

The iconic design is enriched with the inclusion of prestigious striped wood, adding a touch of warmth and sophistication to the range. In addition to the wide selection of materials, from Cristalplant to marble, Falper continues to offer design solutions, creating a unique and refined experience, further enhanced by the presence of the new Gold PVD finish in the Cilindro faucet collection, designed by the same designer.





Eccentrico

Falper amplia ulteriormente la sua celebre e iconica collezione **Eccentrico** disegnata da **Victor Vasilev**, introducendo nuovi materiali e accenti distintivi. Il design si arricchisce con l'inclusione del pregiato legno rigatino, che aggiunge un tocco di calore e raffinatezza alla gamma. La collezione si sviluppa mantenendo la sua essenza originale, ma con un tocco di freschezza e innovazione. Oltre alla vasta scelta di materiali, dal cristalplant al marmo, Falper continua a offrire soluzioni di design creando un'esperienza unica e raffinata.

Falper further expands the renowned **Eccentrico** collection designed by **Victor Vasilev**, introducing new materials and distinctive accents. The iconic design is enriched with the inclusion of precious striped wood, adding a touch of warmth and sophistication to the range. The collection evolves while maintaining its original essence but with a fresh touch of innovation. In addition to a wide selection of materials, from Cristalplant to marble, Falper continues to offer design solutions that create a unique and refined experience.



Le ante della collezione sono realizzate in legno multistrato con superficie massellata in legno di noce e fresata. La qualità e il prestigio di questo manufatto e della collezione rappresentano lo stato dell'arte dell'arredamento per il bagno.

The doors of the collection are made of plywood with solid Walnut massaged surface. The quality and prestige of this artifact and collection represent the state of the art of bathroom furniture.







La lavorazione fresata
su legno massello
è presente anche
nella versione free
standing dell'iconica
collezione disegnata
dall'architetto Vasilev
per Falper.

The milled processing
on solid wood is also
present in the free-
standing version of
the iconic collection
designed by architect
Vasilev for Falper.

**Abaco dimensioni /
Abaco Set dimensions**

H: 36
L: 60 / 80 / 100 / 120 / 140 / 160
L1: 60 / 80 / 100 / 120 / 140 / 160
D: 45

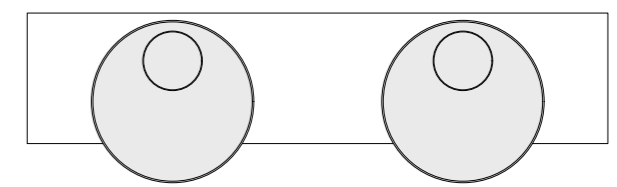
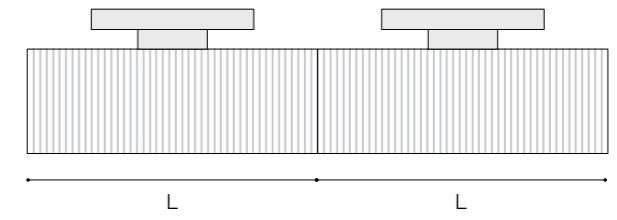
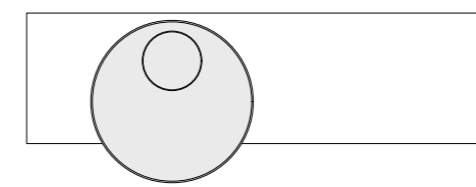
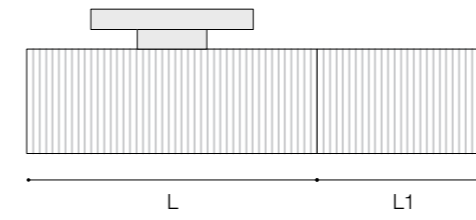
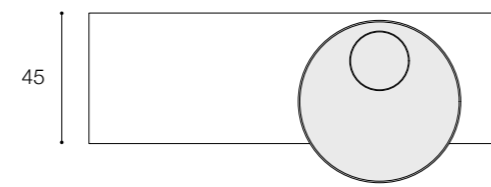
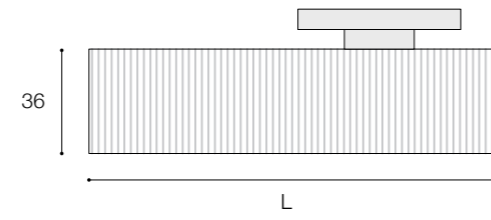

ESSENCE

Quattro.zero *nordic journey*

La collezione Quattro.Zero disegnata dall'architetto Robin Rizzini per Falper nel 2015 rappresenta il punto di riferimento per il mobile da bagno razionale e moderno. In queste pagine le sue perfette e rigorose proporzioni celebrano il design nordico con un uso inedito del colore e della multi matericità della collezione.

The Quattro.Zero collection, designed by architect Robin Rizzini for Falper in 2015, represents the reference point for rational and modern bathroom furniture. In these pages, its perfect and rigorous proportions celebrate Nordic design with an innovative use of color and the multi-materiality of the collection.



Mobile con lavabo
Ciotola e vano a
giorno in finitura
bianco e Curry
opaco, ripreso
anche nella Vasca
della collezione.
Dimensioni mobile
L80, H25, P45 cm.

Unit with Bowl
sink and open
compartment in
glossy white and
mat Curry finish,
also used in the
collection's bathtub.
Unit dimensions
cm L80, H25, W45.



Composizione con
lavabo in Cristalplant
Bio Active e doppio
vano a giorno L 120
H 25 P 45 cm con
in finitura Bianco e
Mango opaco.

Composition with
sink in Cristalplant
Bio Active and double
open compartment L
120 H 25 W 45 cm in
glossy White and mat
Mango finish.



Colonne Quattro.Zero
nelle dimensioni L 25
P 25 H 150 in finitura
Pistacchio opaco su
cemento con panca in
legno carbon nero.

Quattro.Zero columns
in dimensions L 25
W 25 H 150 in matte
Pistachio finish on
concrete with black
carbon wood bench.



LOWVE

Andrea *Federici*

Designer e art director, Andrea Federici si occupa dello sviluppo di intere collezioni di cucine e mobili del bagno per Falper, con un percorso di ricerca iniziato circa una decina di anni fa. Le cucine Small Living Kitchens™, elette miglior progetto di Cucina con il premio EDIDA 2023, sono state disegnate rivolgendosi a coloro che abitano in piccole metrature dal gusto estremamente raffinato, oggetti preziosi e rappresentativi del loro status.

Designer and art director Andrea Federici develops entire collections of kitchens and bath furnishings for Falper, the culmination of ten years in the pursuit of innovative design. Falper's Small Living Kitchens™, winner in the Best Kitchen category of the 2023 EDIDA awards, are designed for people who live in small spaces that reflect highly sophisticated taste – exclusive objects that represent their status.

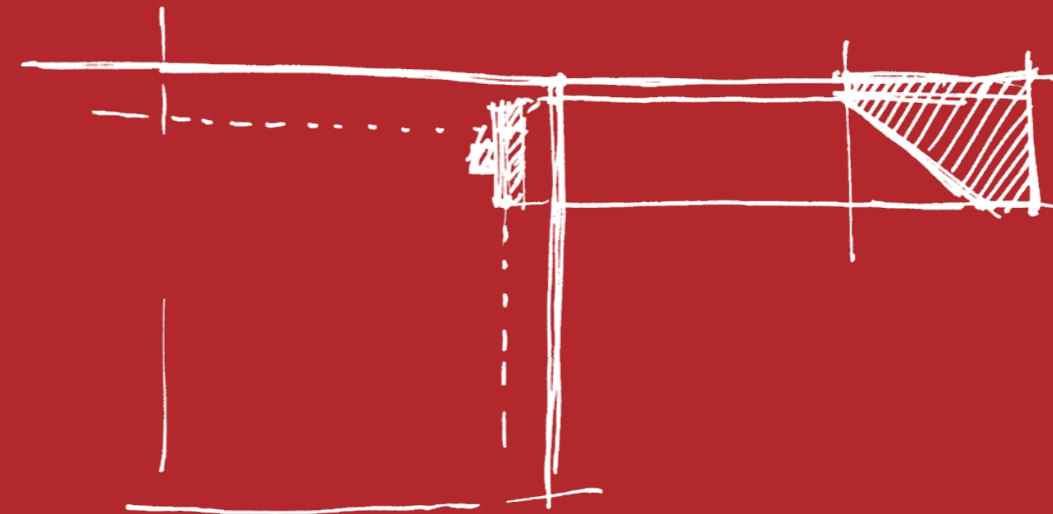

SLK *project*

SLK Project è l'evoluzione del progetto Small Living Kitchens™ di Falper. Da icona delle cucine per spazi ridotti, Small Living Kitchens™ evolve e si affaccia al mondo del contract, offrendo soluzioni egualmente raffinate ma accessibili, grazie a materiali innovativi. La gamma dei colori si amplia, con la possibilità di realizzare cucine bicolore e le piccole isole si arricchiscono di nuovi materiali come il Fenix e nobilitati di altissima qualità, garantendo un'estetica impeccabile e una funzionalità senza pari.

SLK Project is the evolution of Falper's Small Living Kitchens™ project. From an icon of kitchens for small spaces, Small Living Kitchens™ evolves and enters the contract world, offering equally refined but accessible solutions, thanks to innovative materials. The color range expands, with the possibility of creating two-tone kitchens, and small islands are enriched with new materials such as Fenix and high-quality laminates, ensuring impeccable aesthetics and unparalleled functionality.





Isola in Fenix con cassetti interni e piano snack in nobilitato Quercia scuro. Le dimensioni dell'isola sono 150 x 62 x H 90. Nella pagina precedente la versione con Madie bicolore in nobilitato Bianco e Curry opaco.

Island in Fenix with internal drawers and snack top in dark Oak laminate. Island dimensions are 150 x 62 x H 90. On the previous page, the version with two-tone Madie in White and mat Curry laminate.





Una cucina completa in soli 2.5 mq, con isola, tavolo snack, lavastoviglie, frigo, forno e contenimento. Lo charme di una grande cucina, un'inedita semplicità progettuale, ideali per piccole abitazioni con stile e complessi progetti residenziali.

A complete kitchen in just 2.5 sqm, with island, snack table, dishwasher, fridge, oven, and storage. The charm of a large kitchen, an unprecedented design simplicity, ideal for small residences with style and complex residential projects.





Isola in Fenix nero opaco con tavolo e Madie in nobilitato Quercia scuro: illuminazione interna ai cassetti e ai vani a giorni LED.
Dimensioni: Isola 180 x 62 x H 90 cm, Madie 123 x 61 x H 200 cm.

Island in mat black Fenix with table and Madie in dark Oak laminate: internal LED lighting for drawers and open compartments.
Dimensions: Island 180 x 62 x H 90 cm, Madie 123 x 61 x H 200 cm.





Versione Office delle Small Living Kitchens con isola e piano snack e Madia con vano a giorno in nobilitato bianco con interni Quercia chiaro, con vano a giorno per piccoli elettrodomestici. La cucina diviene elemento d'arredo, funzionale e conviviale.

Office version of Small Living Kitchens with island and snack table and Madia with open compartment in glossy white laminate with light Oak interiors, with open compartment for small appliances. The kitchen becomes a furnishing element, functional and convivial.



Inspiration *moodboard*

Le Small Living Kitchens Project si caratterizzano per la possibilità di essere configurate con varie opzioni materiche e cromatiche, combinando tra loro i piani e fianchi delle isole in Fenix, i frontali e le madie in nobilitato bianco, in colore e in nobilitato legno, anche con interni a contrasto.

Small Living Kitchens Project stands out for the possibility of being configured with various material and color options, combining Fenix island tops and sides, laminate fronts, and cabinets in white, color, and wood laminate, even with contrasting interiors.



SLK Project *colors*

Un'attenta selezione di finiture, individuate per funzionalità, resistenza, economicità e appeal, consentono un'ampia personalizzazione del progetto cucina più innovativo del settore. Pochi semplici elementi in grado di soddisfare razionalità progettuale e esigenze di personalizzazione.

A careful selection of finishes, chosen for functionality, durability, cost-effectiveness, and appeal, allows for extensive customization of the most innovative kitchen project in the industry. A few simple elements capable of satisfying design rationality and customization needs.

Isola – Top e fianchi
Island – Top and sides

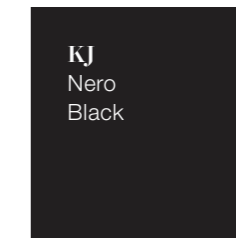
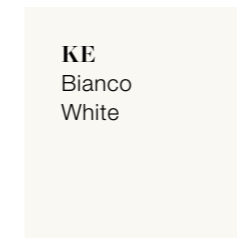

Isola – Frontali, interno cassetti e tavoli / Island – Front panels, Drawer interiors and tables
Madia – Parti a giorno o intera madia / Storage Unit – Open compartment or complete unit

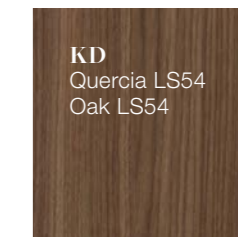
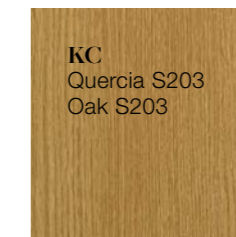
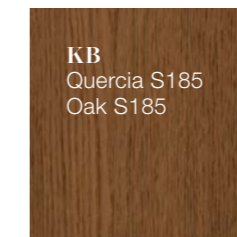

Isola – Frontali / Island – Front panels
Madia – Parti a giorno / Storage Unit – Open compartment

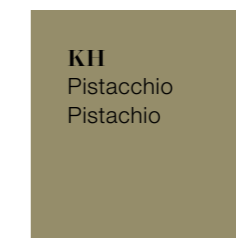
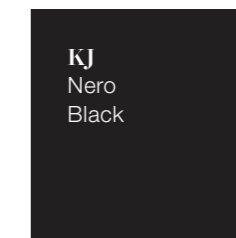
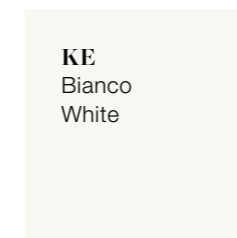

Madia – Intera madia
Storage Unit – Complete unit

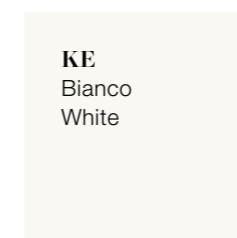

**Abaco dimensioni /
Abaco Set dimensions**

H: 91
L: 120 / 150 / 180
D: 62

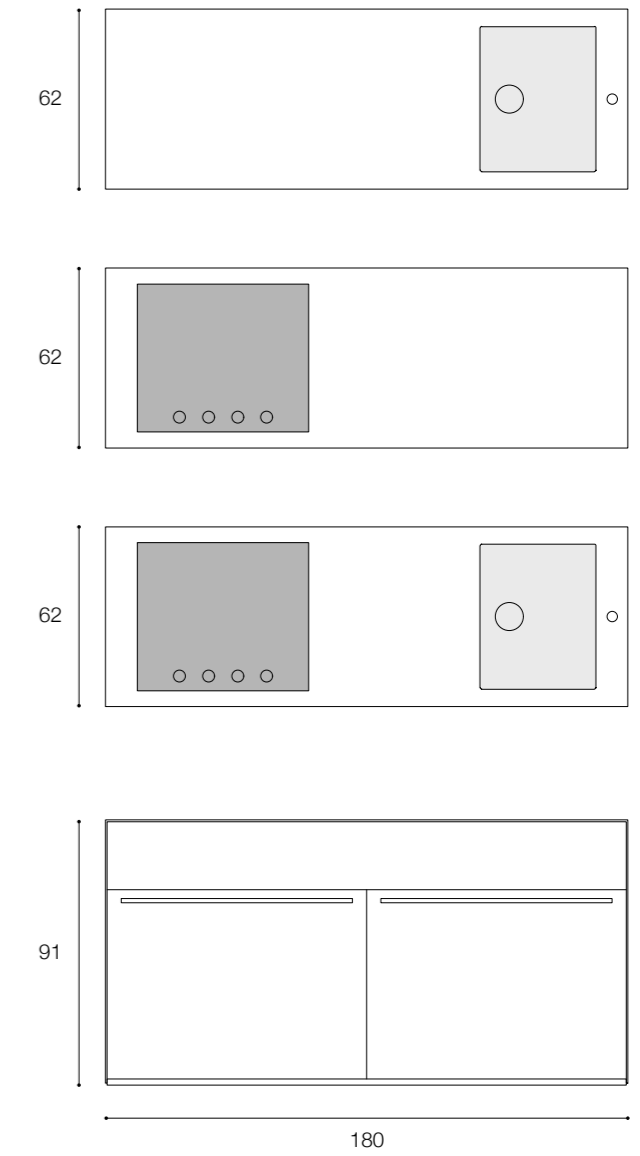
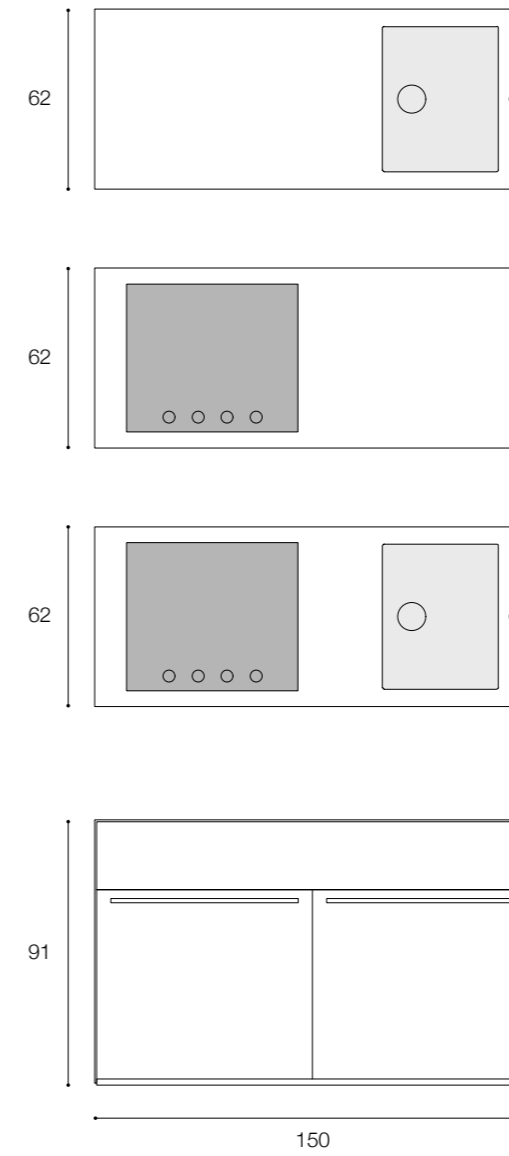
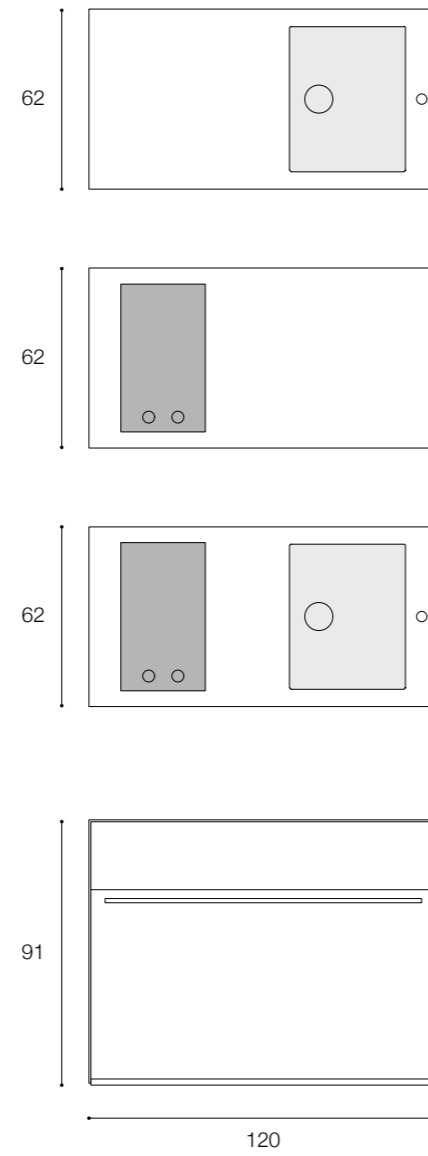

**Abaco dimensioni /
Abaco Set dimensions**

Madia / Storage Unit
N2

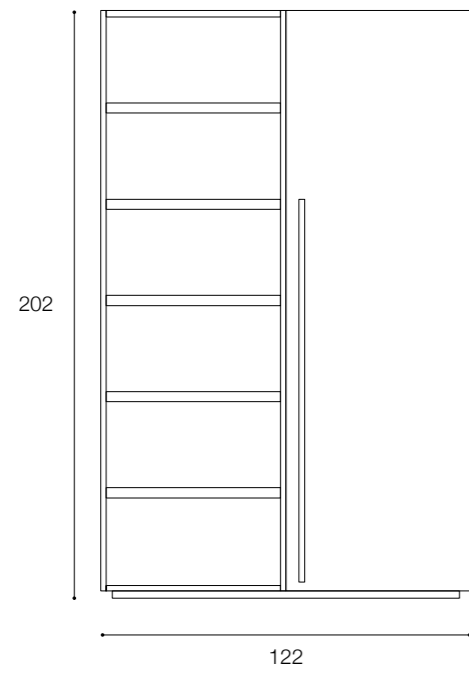

Madia / Storage Unit
N3

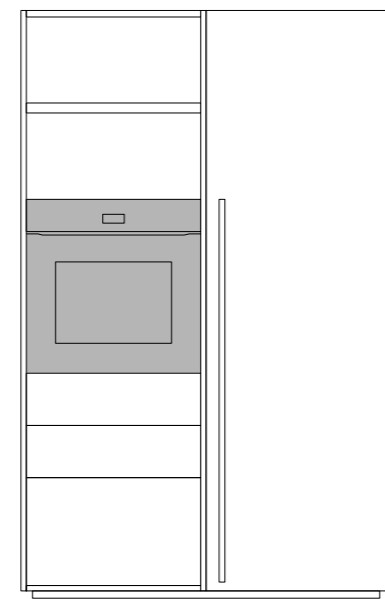

Madia / Storage Unit
N4

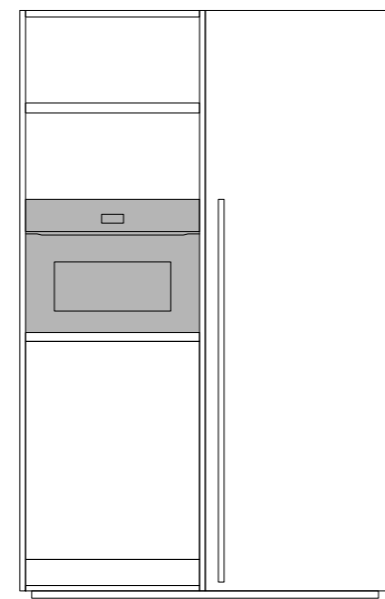

Madia / Storage Unit
N5

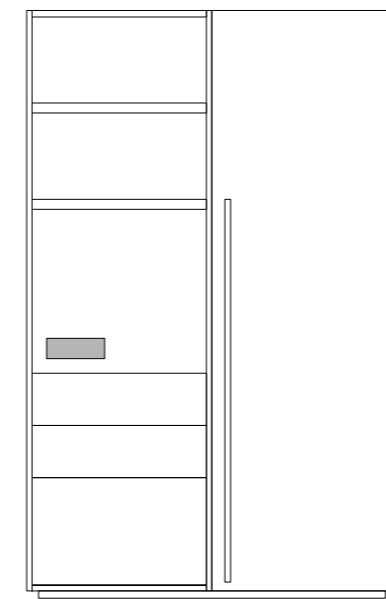

Madia / Storage Unit
N6

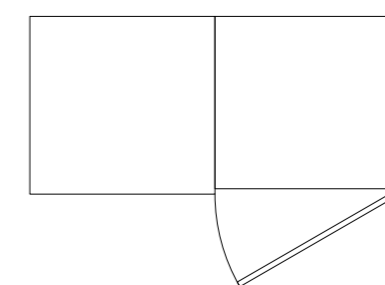
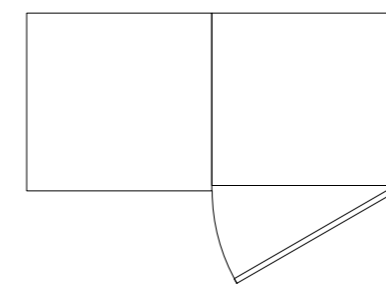
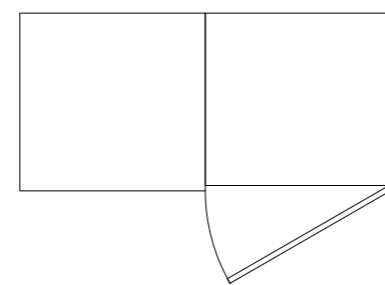
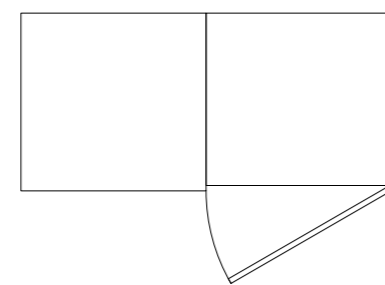
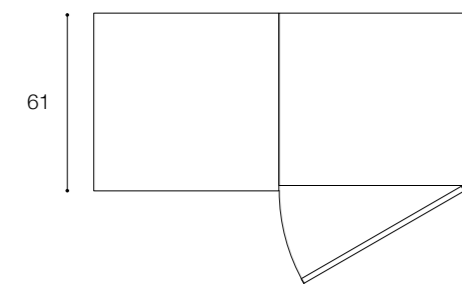
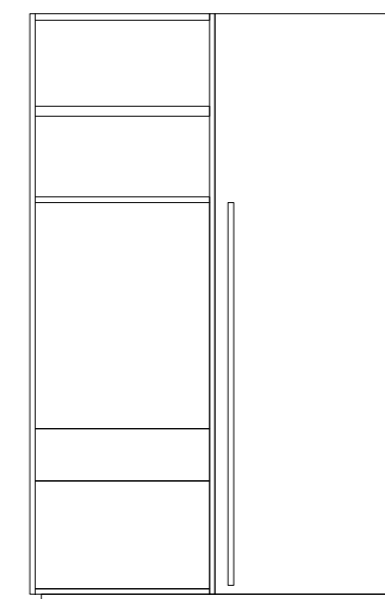

Eleganza elitaria, *materiali pregiati.*

L'eleganza elitaria di Falper si esprime attraverso l'impiego di materiali naturali di grande pregio. Ogni pezzo è frutto di un'attenta selezione e dell'impeccabile artigianalità, realizzato con cura uno ad uno per soddisfare i gusti più esigenti dei nostri clienti. Un pezzo unico in grado di fondere la tecnologia più avanzata all'eleganza tradizionale, garantendo un'esperienza di lusso senza compromessi.

Falper's elitist elegance is expressed through the use of natural materials of great value. Each piece is the result of careful selection and impeccable craftsmanship, made with care one by one to satisfy the most demanding tastes of our clients. A unique piece capable of blending the most advanced technology with traditional elegance, ensuring a luxury experience without compromises.





Viaveneto Classica

p. 16



Viaveneto Frame

p. 42



Viaveneto Sistema Guardaroba

p. 56



Laccati opachi e lucidi / Matt and glossy painted - Cat. 1 / 3

Bo - Bl Bianco White	CU - CJ Calce Lime	IE - IF Calcare Limestone	CB - WB Corda Rope		
ZA - ZI Zolfo Sulfur	CY - CW Curry Curry	B1 - BB Biscotto Cookie	GB - GD Ghiaia Gravel	OA - OB Ombra Shade	IG - IH Cacao Cacao
TA - TC Terracotta Terracotta	MF - MJ Mango Mango	JA - JB Rosso Jaipur Jaipur red	C2 - C1 Creta Clay	TB - T7 Terra Earth	
II - IL Cenere Ash	GL - GH Grigio Londra London Grey	FM - FP Fumo Smoke	TM - T6 Testa di Moro Testa di Moro		
V7 - V8 Verde Agave Agave Green	CD - CL Argilla Argilla	PC - PD Pistacchio Pistachio	VI - VN Visone Mink	BC - BD Basalto Basalt	
AZ - A1 Azzurro Polvere Blue Powder	V1 - V2 Verde Comodoro Green Commodore	G5 - G6 Grigio Bromo Bromo Grey	OQ - OS Ottanio Teal green	BT - BM Blu Notte Night blue	
EY - EZ Grigio Exclusive Exclusive Grey	GF - GT Grafite Graphite	N2 - N1 Nero Black			

Senzafine

p. 66



Ognidove

p. 92

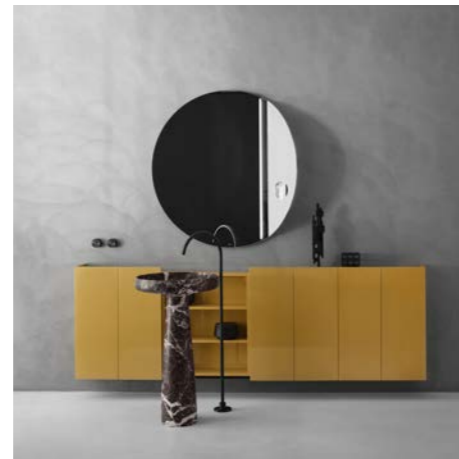

MA

p. 120



4.0

p. 168



Viaveneto Classica
p. 16



Viaveneto Frame
p. 42



Viaveneto Sistema Guardaroba
p. 56



Legni / Woods - Cat. 2

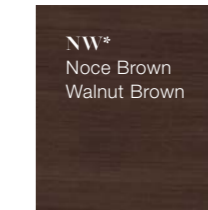
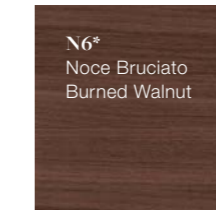
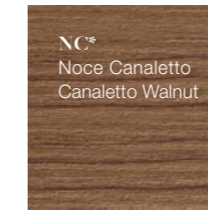
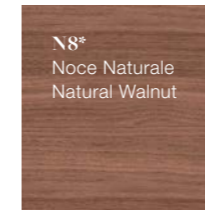
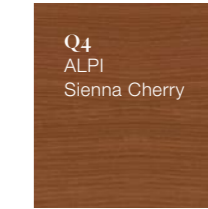

* Selezione per Viaveneto Classica

Legni Cannettati | Striped Woods - Cat. 2

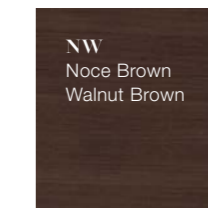
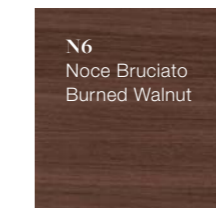
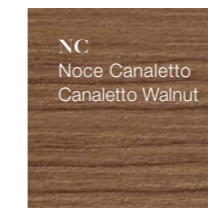
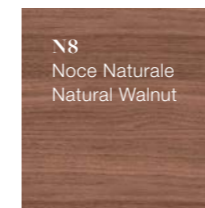

Senzafine
p. 66

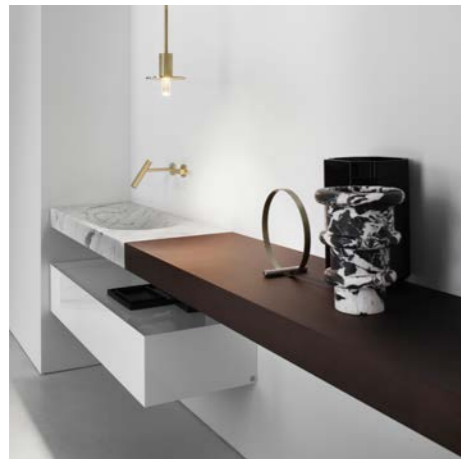

Ognidove
p. 92



MA
p. 120



Viaveneto Frame
p. 42



Eccentrico
p. 154

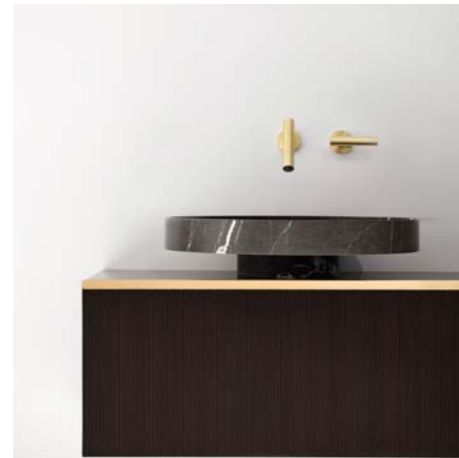

Viaveneto Classica
p. 16



Viaveneto Frame
p. 42



Senzafine
p. 66



Cristalplant Bio Active

00 Bianco White	IE Calcare Limestone	GB Ghiaia Gravel	OA Ombra Shade	B1 Biscotto Cookie
CY Curry Curry	IG Cacao Cacao	TA Terracotta Terracotta	MF Mango Mango	JA Rosso Jaipur Jaipur red
C2 Creta Clay	TB Terra Earth	CD Argilla Argilla	V1 Verde Comodoro Green Commodore	TM Testa di Moro Testa di Moro
GL - GH Grigio Londra London Grey	EY - EZ Grigio Exclusive Exclusive Grey	GF - GT Grafite Graphite	BT Blu Notte Night blue	N2 - N1 Nero Black

MA
p. 120



Sorgente
p. 100



Invaso
p. 50



Glacette
p. 62



Circolo
p. 24



Viaveneto Classica
p. 16



Viaveneto Frame
p. 42



Senzafine
p. 66

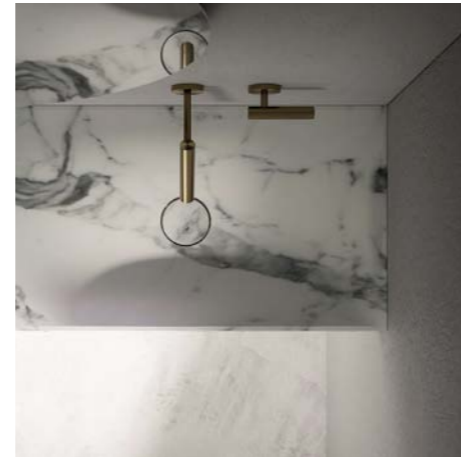

Marmi / Marbles

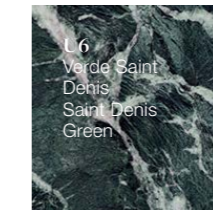
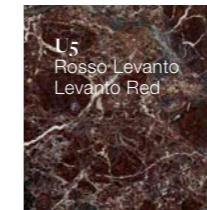
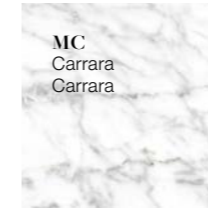

MA
p. 120



Eccentrico
p. 154

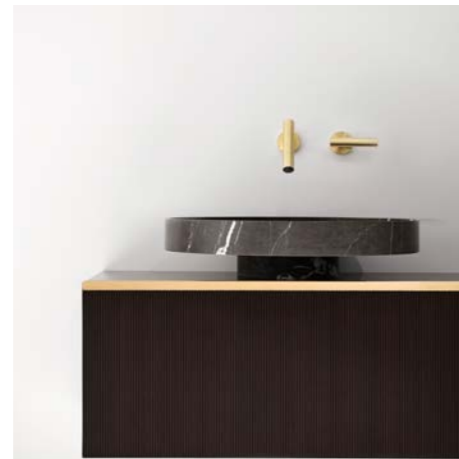

Sorgente
p. 100

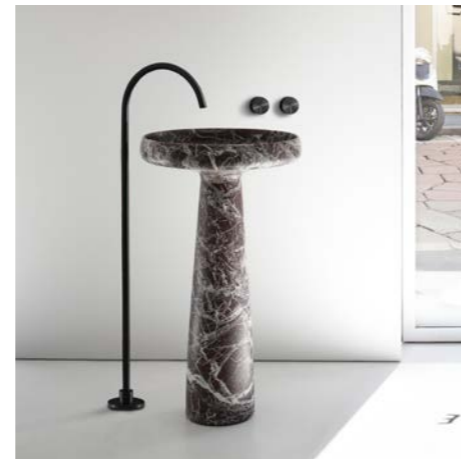

Onda
p. 74



Circolo
p. 24



Cala Fluida
p. 86



MA Elements
p. 128



MA Elements
p. 128



MA Elements
p. 128



Nobilitati / Laminates



KE
Bianco
White



KA
Quercia S181
Oak S181

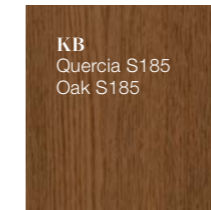

KB
Quercia S185
Oak S185

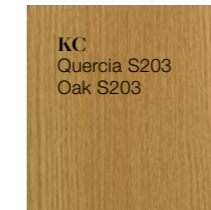

KC
Quercia S203
Oak S203

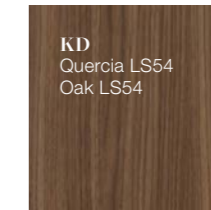

KD
Quercia LS54
Oak LS54

Cilindro

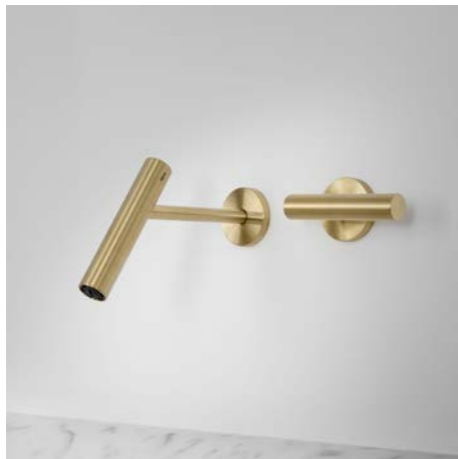

Acquifero

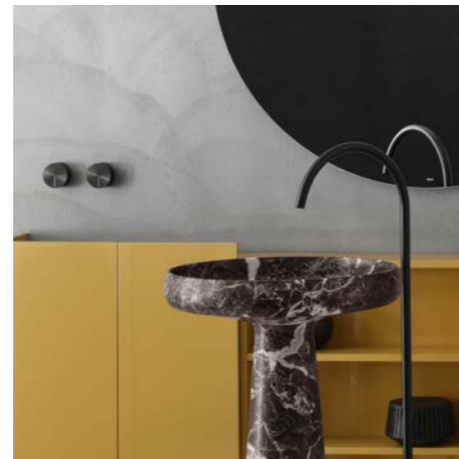

Metalli / Metals



PO
PVD Oro
PVD Gold

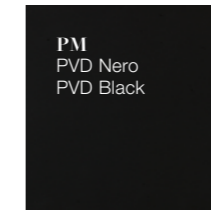

PM
PVD Nero
PVD Black

Credits

Graphic Design
Bianca Previato Schiesari

Photo
Alberto Strada
Giovanni Righetti (p.8–9)

3D Images
Superresolution

Styling
Bruno Tarsia Studio

Thanks to

Amura
Fiammetta V
Mmairo
Mokko
Sandro Lopez

Falper srl

Via Veneto 7 – 9
40064 Ozzano Emilia, Bologna (Italy)

Tel + 39 051 799319
Fax + 39 051 796495
info@falper.it – www.falper.it

Falper srl

Via Veneto 7 – 9

40064 Ozzano Emilia, Bologna (Italy)

Tel + 39 051 799319

Fax + 39 051 796495

info@falper.it – www.falper.it