

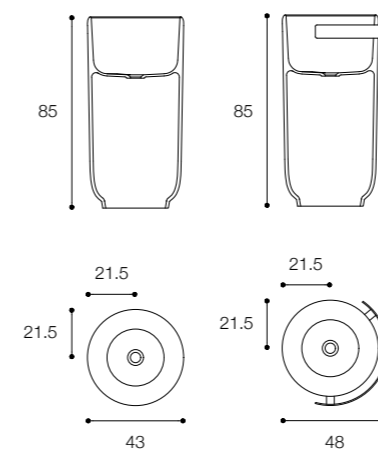

LAVABI FREESTANDING  
FREESTANDING WASHBASINS







## HOMEY

DESIGN SIMONE BONANNI E ATTILA VERESS

Lavabo freestanding in cristalplant biobased  
Freestanding washbasin in biobased cristalplant

Larghezza / Length  
43 / 48 cm

Altezza / Height  
85 cm

Profondità / Depth  
43 / 48 cm

Listino prezzi / Price list — p. 515

● Colori disponibili / Available colors — p. 175





**HANDMADE**  
DESIGN MICHAEL SCHMIDT

Lavabo freestanding in cristalplant biobased  
Freestanding washbasin in cristalplant biobased

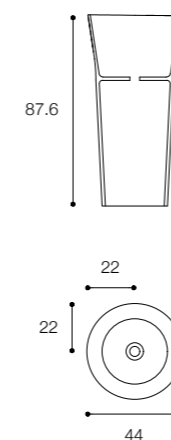

Larghezza / Length  
44 cm

Altezza / Height  
87,6 cm

Profondità / Depth  
44 cm

Listino prezzi / Price list — p. 516

● Colori disponibili / Available colors — p. 174







## CONTROSTAMPO

DESIGN DARIO GAUDIO + VITTORIO VENEZIA

Lavabo freestanding in cristalplant biobased  
Freestanding washbasin in biobased cristalplant

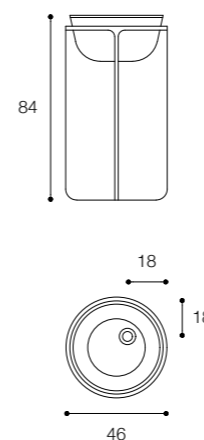

Larghezza / Length  
46 cm

Altezza / Height  
84 cm

Profondità / Depth  
46 cm

Listino prezzi / Price list — p. 516

● Colori disponibili / Available colors — p. 174









**SCOOP**  
DESIGN MICHAEL SCHMIDT

Lavabo freestanding in cristalplant biobased  
Freestanding washbasin in biobased cristalplant

**Brevettato / Patented**

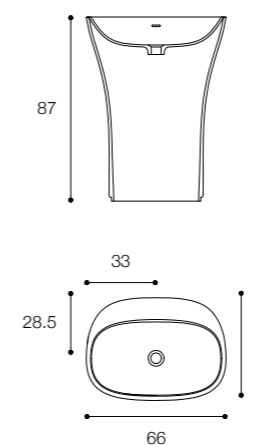

Larghezza / Length  
66 cm

Altezza / Height  
87 cm

Profondità / Depth  
49 cm

Listino prezzi / Price list — p. 517

● Colori disponibili / Available colors — p. 176





## ECCENTRICO DESIGN VICTOR VASILEV

Lavabo freestanding in cristalplant biobased o marmo e legno  
Freestanding washbasin in biobased cristalplant or marble and wood

**Brevettato / Patented**

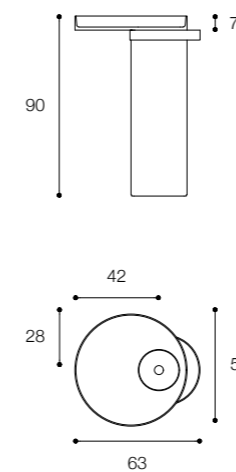

Larghezza / Length  
56 cm

Altezza / Height  
90 cm

Profondità / Depth  
63 cm

Listino prezzi / Price list — p. 518 - 519

● Colori disponibili / Available colors — p. 177









## GEORGE

DESIGN FALPER + MICHAEL SCHMIDT

Lavabo a colonna in Ceramilux con struttura rivestita in legno o pelle e metallo.  
Freestanding washbasin column made in ceramilux with wood or leather structure cover and metal

**Brevettato / Patented**

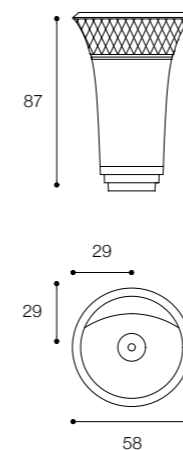

Larghezza / Length  
58 cm

Altezza / Height  
87 cm

Profondità / Depth  
58 cm

Listino prezzi / Price list — p. 522

● Colori disponibili / Available colors — p. 178 - 179

Handmade



Cristalplant biobased

00  
Cristalplant Biobased  
Biobased Cristalplant

Controstampo



Finiture / Finishings

00  
Cristalplant Biobased  
Biobased Cristalplant

Finiture soft touch e corten esterne / External soft touch and corten finishings

- EX**  
Grigio Exclusive  
Exclusive Grey
  - NR**  
Nero  
Black
  - FB**  
Ferro  
Iron
  - V3**  
Visone  
Mink
  - CR**  
Cedro  
Cedar
  - IP**  
Cipria  
Powder
  - W**  
Verde Agave  
Agave Green
- CO**  
Corten  
Corten

Homey



Cristalplant biobased

00  
Cristalplant Biobased  
Biobased Cristalplant

Homey



Metalli / Metals

- TI**  
Inox titanium  
Stainless steel titanium
- RM**  
Rame spazzolato  
Brushed Copper
- OR**  
Ottone spazzolato  
Brushed Brass
- ON**  
Onice  
Onyx
- SA**  
Inox satinato  
Brushed stainless steel



Sccop



Finiture / Finishes



Finiture soft touch e corten esterne / External soft touch and corten finishings



Eccentrico



Cristalplant biobased

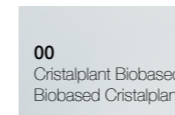

Marmi / Marbles

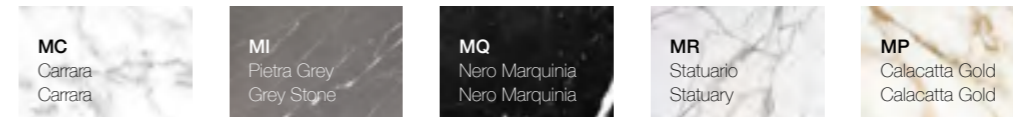

Metalli / Metals

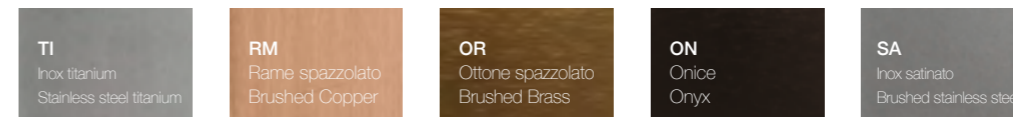

Legni / Woods



Realizzabile in tutte le finiture legno della Cat. 2  
Feasible in all the Cat. 2 wooden finishings

## George



## Laccati opachi / Matt painted - Cat. 1

<b>B0</b> Bianco White	<b>GP</b> Grigio Pavillon Pavillon Grey	<b>PI</b> Pioggia Rain	<b>GL</b> Grigio Londra London Grey	<b>EY</b> Grigio Exclusive Exclusive Grey	<b>GF</b> Grafite Graphite	<b>N2</b> Nero Black
<b>CA</b> Canapa Hemp	<b>S2</b> Sabbia Sand	<b>C2</b> Creta Clay	<b>C7</b> Castoro Ottawa Ottawa Beaver	<b>CD</b> Argilla Argilla	<b>G5 / G6</b> Grigio Bromo Bromo Grey	
<b>FE</b> Ferro Iron	<b>V1</b> Verde Comodoro Commodore Green	<b>FA</b> Fango Mud	<b>VI</b> Visone Mink			
<b>AZ</b> Azzurro Polvere Blue Powder	<b>AV</b> Avio Aviation	<b>B7</b> Blu Fes Fes Blue				
<b>C5</b> Cedro Cedar	<b>I7</b> Cipria Powder	<b>V7</b> Verde Agave Agave Green				

## Metalli / Metals

<b>TI</b> Inox titanium Stainless steel titanium	<b>RM</b> Rame spazzolato Brushed Copper	<b>OR</b> Ottone spazzolato Brushed Brass	<b>ON</b> Onice Onyx	<b>SA</b> Inox satinato Brushed stainless steel	<b>RL</b> Rame lucido Glossy Copper
--	--	---	----------------------------	---	---

## Legni / Woods

<b>R4</b> Rovere Oak	<b>RP</b> Rovere Sbiancato Bleached Oak	<b>RK</b> Rovere Solid Skin Solid Skin Oak	<b>CG</b> Canaletto Grigio Canaletto Grey	<b>N8</b> Noce Naturale Natural Walnut	<b>NC</b> Noce Canaletto Canaletto Walnut
<b>N6</b> Noce Bruciato Burned Walnut	<b>NW</b> Noce Brown Walnut Brown	<b>RG</b> Rovere Grigio Grey Oak	<b>W4</b> Wengè Wengè		

## Pelle / Leather

<b>D1</b> Bohemian Kaki	<b>D2</b> Bohemian Siberia	<b>D3</b> River Nelson	<b>D4</b> Kashmir Nuage	<b>D5</b> Kashmir Fumeé	<b>D6</b> Ecopelle bianca White faux leather
<b>D7</b> Kashmir Sucre	<p>Pelli intere, in primo fiore, trattate con concie e procedimenti speciali che esaltano il vissuto e la morbidezza. Le pelli Baxter sono uniche, irripetibili esattamente come i prodotti Falper. Vanno trattate con cura e curate come si deve ai prodotti di grande pregio. In dotazione con ogni elemento George finito in pelle Baxter il vanity kit per la cura e la manutenzione.</p>				<p>Whole full grain leathers, treated with tanning and special procedures that enhance the experience and softness. Baxter leathers are unique, unrepeatable just like Falper products. To be treated with care and attention as products of great value deserve. For every George element with baxter leather finishing the vanity kit for care and maintenance is included.</p>

